

PATIENT MANUAL

**LATITUDE™ Communicator**

Остаряла версия. Да не се използва.  
Zastaralá verze. Nepoužívat.  
Forældet verze. Må ikke anvendes.  
Version überholt. Nicht verwenden.  
Aegunud versioon. Ärge kasutada.  
Παλιά έκδοση. Μην την χρησιμοποιήσετε.  
Outdated version. Do not use.  
Version obsolete. Ne utilizar.  
Zastarijela verzija. Nemojte upotrebljavati.  
Úreilt útgáfa. Notið ekki.  
Versione obsoleta. Ne pas utiliser.  
Novecojsi versija. Neizmantot.  
Zastarijela verzija. Neizmantot.  
Pasenusi versija. Neizmantot.  
Elavult verzió. Ne használja!  
Dit is een verouderde versie. Niet gebruiken.  
Wersja przeterminowana. Nie używać.  
Versão obsoleta. Não utilize.  
Versione expirată. A nu se utiliza.  
Zastarana verzija. Nepoužívat.  
Zastarela različica. Ne uporabite.  
Vanhentunut versio. Älä käytä.  
Föråldrad version. Använd ej.  
Güncel olmayan sürüm. Kullanmayın.

Остаряла версия. Да не се използва.  
Zastaralá verze. Nepoužívat.  
Forældet version. Må ikke anvendes.  
Version überholt. Nicht verwenden.  
Aegunud versioon. Ärge kasutage.  
Παλιά έκδοση. Μην την χρησιμοποιείτε.  
Outdated version. Do not use.  
Version périmée. Ne pas utiliser.  
Zastarjela verzija. Nemojte upotrebljavati.  
Úrejt útgáfa. Notið ekki.  
Versione obsoleta. Non utilizzare.  
Pasenusi verzija. Neizmanto.  
Zastarjana verzija. Neizmantot.  
Úrejt útgáfa. Notið ekki.  
Novocojusi versija. Nenaudokite.  
Pasenusi verzija. Neizmanto.  
Elavult verzió. Ne használja!  
Dit is een verouderde versie. Niet gebruiken.  
Wersja przeterminowana. Nie używać.  
Versão obsoleta. Não utilize.  
Versione expirată. A nu se utilizează.  
Zastarana verzija. Nepoužívat.  
Zastarela različica. Ne uporabite.  
Vanhentunut versio. Älä käytä.  
Föräldrad version. Använd ej.  
Güncel olmayan sürüm. Kullanmayın.

## About This Manual

This manual applies to Models 6288 and 6290 LATITUDE Communicators, as well as to multiple countries. Unless specified as applying to a particular model or country, instructions apply to all.

The model number for your Communicator is located on its bottom label.

Model 6288 is not available in all locations. Model 6290 is available everywhere.

When color is used in this manual to explain operation of the Communicator, an indicator shown as gray means that it is not lit. An indicator shown as any other color, including white, means that it is lit.



Follow the instructions in this manual when using the Communicator. Keep all of your Communicator information in a convenient location for easy access in the future.

LATITUDE is a trademark of  
Boston Scientific Corporation or its affiliates.

GlobTek is a trademark of GlobTek, Inc.

Excelsus is a trademark of Pulse Electronics.

MultiConnect is a trademark of Multi-Tech Systems, Inc.

SL Power Electronics is a trademark of SL Delaware Holdings, Inc.

The *Bluetooth*® word mark and logos are registered trademarks owned by Bluetooth SIG, Inc. and any use of such marks by Boston Scientific Corporation is under license. Other trademarks and trade names are those of their respective owners.

Остаряла версия. Да не се използва.  
Zastaralá verze. Nepoužívat.  
Forældet version. Må ikke anvendes.  
Version überholt. Nicht verwenden.  
Aegunud versioon. Ärge kasutage.  
Παλιά έκδοση. Μην την χρησιμοποιείτε.  
Outdated version. Do not use.  
Version périmée. Ne pas utiliser.  
Zastarjela verzija. Nemojte upotrebljavati.  
Úrejt útgáfa. Notið ekki.  
Versione obsoleta. Non utilizzare.  
Novecojsi versija. Neizmanto.  
Zastarjana verzija. Nenaudokite.  
Pasenusi versija. Neizmantot.  
Elavult verzió. Ne használja!  
Dit is een verouderde versie. Niet gebruiken.  
Wersja przeterminowana. Nie używać.  
Versão obsoleta. Não utilize.  
Versione expirată. A nu se utiliza.  
Zastarela različica. Ne uporabite.  
Zastarunat versio. Älä käytä.  
Vanhentunut versio. Använd ej.  
Föräldrad version. Kullannmayın.  
Güncel olmayan sürüm. Kullanmayın.

# Table of Contents

<b>ABOUT THE LATITUDE</b>	
<b>PATIENT MANAGEMENT SYSTEM.....</b>	<b>1</b>
<b>The LATITUDE Communicator .....</b>	<b>2</b>
<b>Components of Your Communicator .....</b>	<b>4</b>
<b>Optional Accessories .....</b>	<b>5</b>
<b>The Clinician Website.....</b>	<b>5</b>
<b>Summary of Safety and Clinical Performance .....</b>	<b>5</b>
<b>Clinical Benefits of the Communicator .....</b>	<b>6</b>
<b>USING YOUR COMMUNICATOR.....</b>	<b>7</b>
<b>Important Notes.....</b>	<b>7</b>
<b>Where to Place Your Communicator.....</b>	<b>8</b>
<b>Heart Button and Indicators.....</b>	<b>9</b>
<b>Heart Button and Indicator Descriptions .....</b>	<b>11</b>
<b>Normal Operation of the Communicator .....</b>	<b>16</b>
<b>Using the Heart Button .....</b>	<b>16</b>
<b>Status Button.....</b>	<b>19</b>
<b>Confirming Successful Operation.....</b>	<b>19</b>
<b>Confirming Connection to the Clinician Website.....</b>	<b>20</b>
<b>Canceling an Interrogation.....</b>	<b>20</b>
<b>Loss of Power .....</b>	<b>21</b>
<b>Traveling With Your Communicator.....</b>	<b>21</b>
<b>Care and Maintenance .....</b>	<b>22</b>
<b>Cleaning the Communicator and Accessories .....</b>	<b>23</b>
<b>Returning, Replacing, or Disposing of the             Communicator or Accessories.....</b>	<b>23</b>

<b>SETTING UP YOUR COMMUNICATOR .....</b>	<b>25</b>
Setup Overview .....	25
Confirming/Setting Switch Settings.....	26
Special Instructions if Using the Standard Telephone Connection Method .....	32
Traveling.....	32
Setting Switches 1-3 for Dial-out or Prefix Number.....	32
Setting Up Your Connection Method.....	34
Cellular Connection .....	35
Using Previous Cellular Connection Accessories.....	38
Replacement .....	39
Internet Connection .....	40
Replacement .....	42
Standard Telephone Connection .....	43
Communicator Use of the Telephone, Using the Telephone While the Communicator is Making a Call.....	46
DSL Internet Service .....	47
Replacement .....	47
Hotspot Connection (Mobile Device).....	47
USB Accessory Adapter Connection .....	48
Software Download and Installation .....	49
<b>TROUBLESHOOTING.....</b>	<b>51</b>
Overview .....	51
Indicator Light Errors.....	52
Yellow Wave Errors.....	60

**ADDITIONAL INFORMATION ..... 75**

**LATITUDE Support ..... 75**

**Frequently Asked Questions ..... 77**

**Specifications ..... 80**

**Safety and Standards Compliance.....85**

**European Union Importer ..... 87**

**Essential Performance ..... 87**

**Software Statement ..... 87**

**Electromagnetic Emissions and Immunity ..... 88**

**Explanation of Product and Label Symbols ..... 90**

Остарана верзија. Не користите.  
 Zastarala verzija. Ne uporabite.  
 Forældet version. Ikke anvend.  
 Version überholt. Nicht verwenden.  
 Aegunud versioon. Mõn ei kasuta.  
 Παλιά έκδοση. Μην τη χρησιμοποιείτε.  
 Outdated version. Do not use.  
 Version obsolete. No utilizar.  
 Version périmée. Ne pas utiliser.  
 Zastarijela verzija. Nemojte upotrebljavati.  
 Üreilt ütgäfa. Notið ekki.  
 Versiune obsolete. Nu utilizare.  
 Pasenusi versija. Neizmanto.  
 Elavult verzió. Ne használok.  
 Dit is een verouderde versie. Niet gebruiken.  
 Utdatert versjon. Skal ikke brukes.  
 Wersja przeterminowana. Nie używać.  
 Versão obsoleta. Não utilize.  
 Versiune expirată. A nu se utiliza.  
 Zastarana verzija. Ne uporabite.  
 Zastarela različica. Ne uporabite.  
 Vanhentunut versio. Älä käytä.  
 Föråldrad version. Använd ej.  
 Güncel olmayan sürüm. Kullanmayın.

## List of Figures

Figure 1. Front of Communicator .....	9
Figure 2. Status Button.....	19
Figure 3. Location of Switches.....	26
Figure 4. Dial-out Number Switch Settings (1-3).....	33
Figure 5. Back of Communicator .....	34
Figure 6. Connecting a USB Cellular Adapter .....	35
Figure 7. Connecting a USB Ethernet Adapter .....	40
Figure 8. Connecting a Telephone Cable.....	43
Figure 9. Connecting a USB Accessory Adapter .....	48



## ABOUT THE LATITUDE PATIENT MANAGEMENT SYSTEM

The LATITUDE Patient Management System (“LATITUDE System”) is a remote monitoring system that uses the LATITUDE Communicator to collect data from your implanted device. Your Communicator then sends this data to the Clinician Website for access by your health care provider.

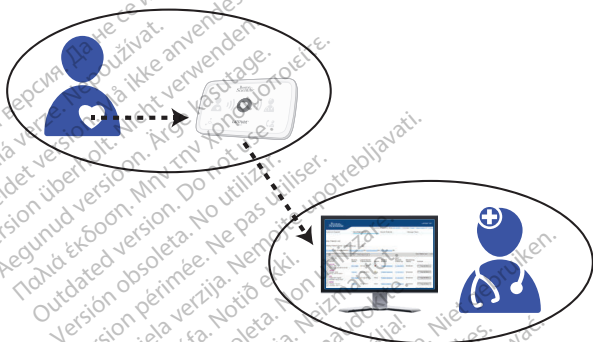

The LATITUDE System is designed to help your health care provider manage your ongoing care in a manner that is convenient for both of you.

The LATITUDE System uses advanced security methods to protect your personal medical information. Only authorized health care providers have access to your information through the password-protected Clinician Website.

**CAUTION:** *The LATITUDE System is not meant to assist with health emergencies. If you are not feeling well or need urgent health care, call your health care provider or your local emergency service.*

## The LATITUDE Communicator



The LATITUDE Communicator is an in-home, wireless monitor that automatically collects and sends your implanted device data to the Clinician Website for access by your health care provider.

The Communicator collects data from your implanted device in three different ways:

- **Routine Device Checks:** The Communicator “checks in” on your implanted device daily or weekly, depending on what type of implanted device you have. The collected data will be sent to the Clinician Website only as needed.
- **Scheduled Follow-ups:** At times set by your health care provider (typically every few months), your Communicator collects and then sends your implanted device data to the Clinician Website.
- **Manual:** If this feature is enabled by your health care provider, you may initiate the Communicator to read your implanted device by pressing the Heart button on your Communicator. Only use this feature when the Heart button is flashing or when instructed to do so by your health care provider.

Routine device checks and scheduled follow-ups may happen automatically without your knowledge, or you may need to press the Heart button when it flashes to complete the process.

Refer to “Using the Heart Button” on page 16 for more information.

Your health care provider may also send periodic updates to your Communicator to change the schedule for reading data from your implanted device.

In order for your Communicator to be able to send your implanted device data to the Clinician Website, a connection accessory must be set up on your Communicator. Refer to “Setting Up Your Communicator” on page 25 for directions. Contact your health care provider to learn which connection accessory is right for you.

This equipment needs to be installed and put into service in accordance with the information in the provided documentation. Call your health care provider if you need assistance setting up or using your Communicator.

*The Communicator does not provide continuous monitoring.*

*The Communicator does not reprogram or change any functions of your implanted device. Only your health care provider can do this during an office visit.*

The Communicator is designed to work only with your implanted device. It will not work with another patient's implanted device. The Communicator should be used only as authorized by the prescribing physician. The Communicator is not for use with any implanted device other than a Boston Scientific device.

Ask your health care provider if you have questions about any risks with using the Communicator or your implanted device. For valuable information about the risks and reliability of your implanted device, refer to your implanted device patient handbook.

## Components of Your Communicator

Every LATITUDE Communicator comes with a power supply, a Quick Start Guide, and this Patient Manual.

The following table lists compatible accessories for your Communicator. Availability of these accessories depends on your location and the method you are using to connect to the Clinician Website. For more information about the accessories or how to obtain them, contact your health care provider.

Boston Scientific Model Number	Accessory Name (as referenced in this manual)
6250*	Power supply (replacement)
<b>Connection Accessories</b>	
6359	3G USB cellular adapter (current model)
6205/6213	4G USB cellular adapter (current models)
6293	USB Ethernet adapter
6250*	Telephone cable (may be included)
6250*	Telephone jack adapter
6421	DSL filter
6454	USB accessory adapter
6296	3G USB cellular adapter (previous model)
6456 (MT200A2W Multi-Tech Model Number)	Analog-to-wireless cellular converter (previous model)
<b>Optional (must be prescribed by your health care provider)</b>	
6487	Weight scale
6452	Blood pressure monitor

\* Available only through Model 6250 accessory kit.

Only use the accessories listed in the table or provided by your health care provider. Accessories acquired elsewhere may not work with your Communicator.

## Optional Accessories

*(The optional accessories described in this section are not available in all locations. Contact your health care provider for more information.)*

If prescribed by your health care provider, your Communicator may include a weight scale and blood pressure monitor.

These specially designed products provide additional information to monitor your health. Refer to the handbook that is included with the weight scale and blood pressure monitor for more information.

A USB accessory adapter is included with the weight scale and blood pressure monitor. The USB accessory adapter provides a wireless connection between these products and your Communicator. Refer to "USB Accessory Adapter Connection" on page 48 for more information.

## The Clinician Website

Between office visits, the Clinician Website gives your health care provider access to the implanted device data that was collected and sent by your Communicator. The Clinician Website features advanced analysis and trending tools designed to help your health care provider improve your care.

Your implanted device information is typically available on the Clinician Website within 15 minutes of when your Communicator sent it. However, it may sometimes take longer due to external factors.

## Summary of Safety and Clinical Performance

For customers in the European Union: visit <https://ec.europa.eu/tools/eudamed> to view a summary of this device's safety and clinical performance information.

## Clinical Benefits of the Communicator

If used as indicated, when compared to in-person clinical evaluations only, remote monitoring:

- Reduces the number of in-person clinical evaluations at the clinic.
- Improves the consistency of follow-up by your health care provider.
- Provides more information on certain heart conditions to your health care provider.

For a more detailed description of clinical benefits, please consult <https://ec.europa.eu/tools/eudamed>, and discuss with your health care provider which provisions may apply to you.

## USING YOUR COMMUNICATOR

Before you can use your Communicator, you must first set it up to connect to the Clinician Website. Refer to “Setting Up Your Communicator” on page 25 for directions on setting up your connection accessory. Contact your health care provider to learn which connection accessory is right for you.

**Note:** If there is a delay between receiving your Communicator and setting it up, a newer version of Communicator may be necessary in order to connect to the Clinician Website.

### Important Notes

*Check your Communicator every day to see if any of the indicators are lit solid or flashing. Refer to “Heart Button and Indicators” on page 9 and the Troubleshooting section starting on page 51 for more information on the meaning of indicator lights.*



*Call your health care provider if the Call Doctor Icon lights red (flashing or solid).*

*It is very important that the Communicator is **always** plugged into an electrical outlet that has power.*

- **Electrical safety:** It is recommended that you install a surge protector between the electrical wall outlet and the Communicator. This is to avoid damage to the Communicator caused by local lightning strikes and other electrical surges. Electrical cable wall plugs and other accessories must be in good condition before use.

## Where to Place Your Communicator

Place your Communicator:

- Near an electrical outlet that is easily accessible.
- Within 3 m (10 ft) from your bedside or where you sleep. If this is not possible, place your Communicator where you spend a considerable amount of time each day.
- Where you can sit comfortably and see the front of the Communicator.
- Where the Communicator and all its cables and accessories will be kept dry and not exposed to humidity or potential water contact.
- Refer to the following sections for more placement advice depending on your connection method:
  - “Cellular Connection” on page 35
  - “Internet Connection” on page 40
  - “Standard Telephone Connection” on page 43
- Some household appliances and other sources of electromagnetic energy could interfere with wireless communication between the Communicator and your implanted device. When you are using the Communicator, it should be at least 30 cm (12 in) away from televisions, digital video disc (DVD) players, personal computers, modems, routers, microwaves, and other electronic equipment.
- If you have an S-ICD implanted device supported on LATITUDE, the wireless communication between the Communicator and your S-ICD is sensitive to distance and orientation. You may need to move closer to the Communicator, or you may need to position your body such that a clear signal exists between your S-ICD and the Communicator. If you need assistance, contact LATITUDE Support at the telephone number for your country listed on page 75.



- Boston Scientific personnel may contact you or your health care provider if it is determined that your implanted device is using too much radio-frequency (RF) telemetry due to the placement of your Communicator. Boston Scientific will give advice on better Communicator placement to correct this issue.

## Heart Button and Indicators

The following figure shows the Heart button and all the indicators on the front of your Communicator. Use this figure for reference as you follow this manual's instructions for using your Communicator.

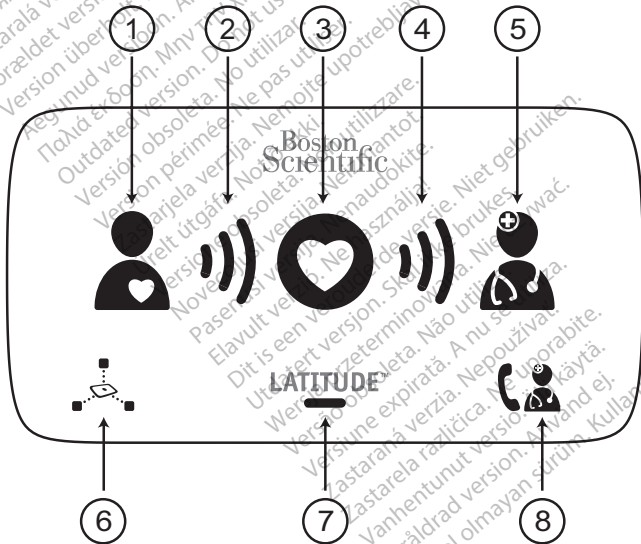

(1) Patient icon; (2) Collecting Waves; (3) Heart button; (4) Sending Waves; (5) Doctor icon; (6) Sensor Reading icon; (7) LATITUDE indicator; (8) Call Doctor icon

Figure 1. Front of Communicator

The Heart button and indicators are intended to inform you of the status of your Communicator or actions you may need to take. The lights, colors, and sequence of each indicator shown in Figure 1 are explained in the following section.

**Note:** When the words “interrogate” or “interrogation” are used in this manual, it means that the Communicator is collecting data from your implanted device.

If indicators light other than as explained in this section, refer to the applicable error in the Troubleshooting section starting on page 51 to find out if you need to take any action.

Остаряла версия. Да не използвате.  
Zastaralá verze. Nepoužívejte.  
Forældet version. Må ikke anvendes.  
Version überholt. Nicht verwenden.  
Aegunud versioon. Ärge kasutage.  
Παλιά έκδοση. Μην την χρησιμοποιείτε.  
Outdated version. Do not use.  
Version obsolete. Ne utilizar.  
Version périmée. Ne pas utiliser.  
Zastarijela verzija. Neizkoristujte.  
Úreilt útgáfa. Notið ekki.  
Versione obsolete. Nemojte upotrebljavati.  
Novecojuši versija. Neizkoristujte.  
Pasenusi versija. Neizmantot.  
Elavult verzió. Ne használjate.  
Dit is een verouderde versie. Niet gebruiken.  
Wersja przeterminowana. Nie używać.  
Versão obsoleta. Não utilize.  
Versione expirată. A nu se utiliza.  
Zastarana verzija. Nepoužívat.  
Vanhentunut versio. Älä käytä.  
Föråldrad version. Använd ej.  
Güncel olmayan sürüm. Kullanmayın.

## Heart Button and Indicator Descriptions



### Heart Button

---

- A flashing white Heart button indicates:
  - Setup is occurring (refer to “Setting Up Your Communicator” on page 25), or
  - You need to complete a scheduled follow-up (interrogation).

Press the Heart button to complete.

- A solid white light for 2 minutes means the interrogation is complete. Note that the solid white light may appear dim.
- An unlit Heart button may also be used to manually initiate an interrogation of your implanted device. Only press an unlit Heart button when instructed to do so by your health care provider. Refer to “Using the Heart Button” on page 16 before pressing this button.





## Patient Icon

---

Shows the Communicator is interrogating your implanted device.

- Lights solid blue when the Heart button is pressed and an interrogation has started.
- Lights solid blue for 2 minutes after a successful interrogation.

## Collecting Waves

---

Shows the Communicator is interrogating your implanted device.

- Each wave flashes green in sequence and repeats, showing the Communicator is interrogating your implanted device.
- All three waves light green for 2 minutes to indicate the interrogation was a success.



## Sending Waves

---

Shows the Communicator is connecting to the Clinician Website.

- Each wave flashes green in sequence and repeats, showing a connection to the Clinician Website is in progress.
- All three waves light green for 2 minutes to indicate the connection to the Clinician Website was a success and any collected device data was sent.



## Doctor Icon

---

Lights blue for 2 minutes to indicate the Communicator has successfully connected to the Clinician Website. The Communicator sends any data it has collected from your implanted device or prescribed weight scale or blood pressure monitor.



## Sensor Reading Icon

---

Shows the Communicator has successfully communicated with a prescribed weight scale or blood pressure monitor.

**Note:** This icon does not apply to your implanted device.

- Flashes green 5 times and lights solid green for 5 minutes to indicate the Communicator successfully received a weight or blood pressure measurement.

## LATITUDE Indicator

---

Shows the Communicator is connected to electrical power and ready to use. It also shows if the Communicator startup process is being performed.

- Lights green to indicate the Communicator is connected to electrical power and is ready to use.
- Flashes yellow briefly after the Communicator is plugged into electrical power (startup).
- May flash yellow for a longer period of time. This means that new software is being installed on the Communicator.



## Call Doctor Icon

Lights yellow or red (flashing or solid) to signal a problem that you should report to your health care provider. Refer to the applicable error in the Troubleshooting section starting on page 51 for more information.

- Flashes yellow briefly after the Communicator is plugged into electrical power (does not require contacting your health care provider). It then turns off after the Communicator completes the startup process.
- Lights solid yellow if the startup process does not complete.



**If the Call Doctor icon lights red (flashing or solid), call your health care provider.**

## Normal Operation of the Communicator



LATITUDE™



When operating normally, only the LATITUDE indicator will light green as shown above. None of the other Communicator indicators will typically light when collecting or sending your implanted device data, except when the Heart button has been pressed.

**Note:** In this manual, a gray heart shown inside the blue circle means that it is not lit; a white heart means that it is lit.

### Using the Heart Button

*Always press the Heart button when it is flashing or when told to do so by your health care provider. Stay next to the Communicator until lights are lit as shown here.*



*Do not press the Heart button if it is unlit unless instructed to do so by your health care provider.*

The following sequence shows the normal light sequence when the Heart button is pressed.



1. The Communicator begins interrogating your implanted device after the Heart button is pressed.

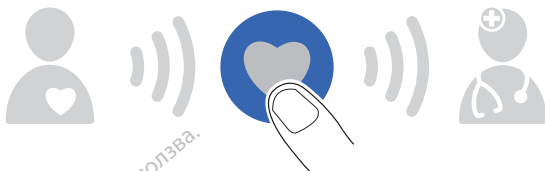

2. The Patient icon lights blue. The Collecting Waves flash green in sequence and repeat while the Communicator interrogates your device.



3. All three Collecting Waves light green. The Heart button lights solid white, showing the interrogation was a success.



- The Sending Waves flash green in sequence and repeat while the Communicator sends your data to the Clinician Website.



- The Doctor icon lights blue showing the Communicator successfully sent your data to the Clinician Website. The indicators stay lit for 2 minutes to show the entire process was a success. No further action is required.



**CAUTION:** Normal use of the LATITUDE System has been accounted for in the projected battery life of your implanted device. Pressing the Heart button more often than when the Heart button flashes, or when instructed to do so by your health care provider, may lead to a decrease in the battery life of your implanted device.

# Status Button

## Confirming Successful Operation

Periodically press the Status button on the back of the Communicator ("Figure 2. Status Button") for **1 second** to confirm that it has been successfully collecting data from your implanted device and sending it to your health care provider.

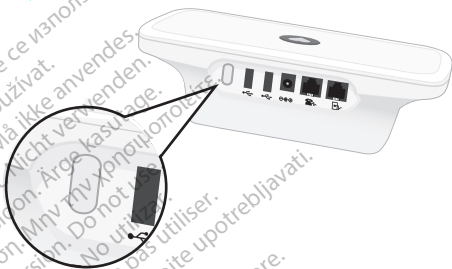

**Figure 2. Status Button**

The resulting indicators will stay lit for 2 minutes. If you see the following image—all six Collecting and Sending Waves lit green—your Communicator is working correctly. No further action is needed.



If the indicators are different than the above image, refer to the applicable error in the Troubleshooting section starting on page 51 to learn what actions you should take.

**Note:** If you pressed the Heart button before pressing the Status button, the Status button will not function until the resulting interrogation is completed or is canceled. For information on canceling an interrogation, see page 20.

## Confirming Connection to the Clinician Website

If you have moved your Communicator, changed the connection method, or made other changes to the Communicator, you should confirm that your Communicator still successfully connects to the Clinician Website. To do so, press and hold the Status button for more than **3 seconds**. The Sending Waves flash green in sequence and repeat.

**Note:** If both Collecting and Sending Waves light, you did not press the Status button long enough. In that case, wait for the sequence to end. Then press the Status button again for **more than 3 seconds**.

Wait a few minutes for the connection to complete.

If all three Sending Waves light a solid green as shown in the following image for 2 minutes, the connection was a success.



If the Sending Waves are other than all lit solid green, refer to the applicable error in the Troubleshooting section starting on page 51 to learn what actions you should take.

## Canceling an Interrogation

If you press the Heart button by mistake (not intending to perform an interrogation), press and hold the Heart button again for at least **5 seconds** to cancel the interrogation.

The Collecting Waves may flash yellow in sequence and repeat while the interrogation is being canceled.

## Loss of Power

The Communicator has internal memory that stores your implanted device data and other information in case the electrical power is interrupted or the power supply is unplugged. The LATITUDE indicator will transition back to green from being unlit once power is restored to the Communicator.

If the LATITUDE indicator does not transition back to green within 15 seconds after power is restored, unplug the power supply from both the wall outlet and the Communicator for **1 minute**. After 1 minute, reconnect the power supply to both. Lights will flash during the transition. If the LATITUDE indicator is still not lit, contact your health care provider.

## Traveling With Your Communicator

If you will be away from home for an extended period of time (multiple days or weeks), consult with your health care provider to determine whether you should take your Communicator with you. If you take it with you, your health care provider may need to temporarily change your interrogation schedule. If you are traveling outside the country, your health care provider may need to give you information about connecting to the Clinician Website in the new country. There may be limitations depending on the country, model of Communicator, and connection method.

In general, telephone connections are limited to specific countries. Cellular connections work in most but not all countries. Internet works everywhere, depending on signal availability. Local limitations may apply.

Contact your health care provider for more information.

If you take your Communicator with you, check that the Communicator can connect to the Clinician Website from your new location. Refer to “Confirming Connection to the Clinician Website” on page 20.

*Europe only:* When traveling to a country outside of the European Economic Area, the data transmitted from the Communicator will be subject to laws of that country. The laws of that country may provide less privacy protection for your data than the laws of your home country. Please contact your health care provider for specific information about data privacy.

## Care and Maintenance

Your Communicator does not require any regular service, maintenance, or electrical safety testing.

To ensure optimum performance of your Communicator and accessories and protect them from damage, follow these directions:

### CAUTIONS:

- Do not drop or mishandle the Communicator or its accessories in a manner that would cause damage.
- Avoid getting liquid on the unit other than cleaning it as recommended. Do not use abrasive cloth or solvents to clean the unit.
- Do not submerge the Communicator or its accessories in liquid.
- Do not attempt to open the Communicator or any of its accessories.
- Use this unit as described in this instruction manual. Use only authorized parts and accessories. Do not attempt to modify or alter this unit or accessories.

If your Communicator or accessories become damaged or malfunction, contact your health care provider.

## Cleaning the Communicator and Accessories

When necessary, clean the Communicator and its accessories with a soft, clean, lint-free cloth moistened in water or mild detergent.

### CAUTIONS:

- Do not use other cleaning fluids. They may damage the front of the Communicator. Never spray any cleaning fluid directly on the front of the Communicator. Do not allow moisture to accumulate on the front of the Communicator, especially on or around the Heart button.
- Avoid using any cleaning fluid near the electrical plugs on the back of the Communicator.

Note that the finish on some types of furniture could be affected as a result of continuous contact with rubber material such as the type used on the base of the Communicator.

### Returning, Replacing, or Disposing of the Communicator or Accessories

If you need to replace your Communicator or any accessories because of damage or malfunction, or if you need a different model, contact your health care provider to learn how to return and replace it.

If you no longer need to use either your Communicator or any accessories, contact your health care provider to learn how to return them.

Your Communicator may contain private, encrypted health data. Dispose of it only as described above.

Остаряла версия. Да не се използва.  
Zastaralá verze. Nepoužívat.  
Forældet version. Må ikke anvendes.  
Version überholt. Nicht verwenden.  
Aegunud versioon. Ärge kasutage.  
Παλιά έκδοση. Μην την χρησιμοποιείτε.  
Outdated version. Do not use.  
Version périmée. Ne pas utiliser.  
Zastarjela verzija. Nemojte upotrebljavati.  
Úrejt útgáfa. Notið ekki.  
Versione obsoleta. Non utilizzare.  
Novecojsi versija. Neizmantot.  
Pasenusi verzija. Nenaudokite.  
Elavult verzió. Ne használja!  
Dit is een verouderde versie. Niet gebruiken.  
Wersja przeterminowana. Nie używać.  
Versão obsoleta. Não utilize.  
Versione expirată. A nu se utiliza.  
Zastarana verzija. Nepoužívat.  
Zastarela različica. Ne uporabite.  
Vanhentunut versio. Älä käytä.  
Föräldrad version. Använd ej.  
Güncel olmayan sürüm. Kullanmayın.



# SETTING UP YOUR COMMUNICATOR

---

## Setup Overview

Setting up your Communicator to connect to the Clinician Website can be done in 2 main steps:

1. Confirm/set the switches on the bottom of your Communicator. Refer to “Confirming/Setting Switch Settings” on page 26.
2. Use the instructions for one of the following connection methods to connect to the Clinician Website:
  - “Cellular Connection” on page 35
  - “Internet Connection” on page 40
  - “Standard Telephone Connection” on page 43
  - “Hotspot Connection (Mobile Device)” on page 47

*Not every connection method is available in all locations. Contact your health care provider to learn which connection method is available and right for you.*

*Only one connection method can be used with your Communicator—cellular, internet, standard telephone, or hotspot. Using more than one connection method at a time may result in your Communicator failing to connect to the Clinician Website.*

*Stay close to your Communicator during the entire setup process to ensure the best connection between your implanted device and the Communicator.*

## Confirming/Setting Switch Settings

The 8 white switches located on the bottom of your Communicator must be set correctly for connection to the Clinician Website. The switches are either “on” (in the up position) or “off” (in the down position). The switches may or may not already be correctly set when you receive your Communicator.

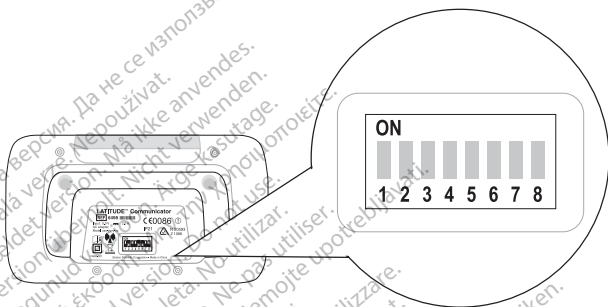

**Figure 3. Location of Switches**

*The correct switch settings for your Communicator depend on your country, as well as supported method of connection to the Clinician Website.*

*Refer to “Table 1. Switch Settings” and compare the switch settings shown for your country and method of connection to the switch settings on the bottom of your Communicator.*









*If they match, no action is needed. If they do not match, slide the switches up or down so that they do match.*

Table 1. Switch Settings

Country	Switch Settings Per Supported Connection Method	
	Cellular or Internet	Standard Telephone*
Australia	<p>ON</p> <p>1 2 3 4 5 6 7 8</p>	<p>ON</p> <p>1 2 3 4 5 6 7 8</p>
Austria	<p>ON</p> <p>1 2 3 4 5 6 7 8</p>	<p>ON</p> <p>1 2 3 4 5 6 7 8</p>
Belgium	<p>ON</p> <p>1 2 3 4 5 6 7 8</p>	<p>ON</p> <p>1 2 3 4 5 6 7 8</p>
Czech Republic	<p>ON</p> <p>1 2 3 4 5 6 7 8</p>	<p>ON</p> <p>1 2 3 4 5 6 7 8</p>
Denmark	<p>ON</p> <p>1 2 3 4 5 6 7 8</p>	<p>ON</p> <p>1 2 3 4 5 6 7 8</p>
Finland	<p>ON</p> <p>1 2 3 4 5 6 7 8</p>	<p>ON</p> <p>1 2 3 4 5 6 7 8</p>
France	<p>ON</p> <p>1 2 3 4 5 6 7 8</p>	<p>ON</p> <p>1 2 3 4 5 6 7 8</p>

Country	Switch Settings Per Supported Connection Method	
	Cellular or Internet	Standard Telephone*
Germany		
Greece		
Hong Kong		
Hungary		
Iceland		Not available
Ireland (Republic)		
Italy		

Country	Switch Settings Per Supported Connection Method	
	Cellular or Internet	Standard Telephone*
Kuwait	<p>ON</p> <p>1 2 3 4 5 6 7 8</p>	Not available
Lebanon	<p>ON</p> <p>1 2 3 4 5 6 7 8</p>	Not available
Malaysia	<p>ON</p> <p>1 2 3 4 5 6 7 8</p>	Not available
Netherlands	<p>ON</p> <p>1 2 3 4 5 6 7 8</p>	<p>ON</p> <p>1 2 3 4 5 6 7 8</p>
New Zealand	<p>ON</p> <p>1 2 3 4 5 6 7 8</p>	<p>ON</p> <p>1 2 3 4 5 6 7 8</p>
Norway	<p>ON</p> <p>1 2 3 4 5 6 7 8</p>	<p>ON</p> <p>1 2 3 4 5 6 7 8</p>
Poland	<p>ON</p> <p>1 2 3 4 5 6 7 8</p>	<p>ON</p> <p>1 2 3 4 5 6 7 8</p>

Country	Switch Settings Per Supported Connection Method	
	Cellular or Internet	Standard Telephone*
Portugal		
Qatar		Not available
Saudi Arabia		Not available
Singapore		Not available
Slovak Republic		
South Africa		Not available
South Korea		Not available

Country	Switch Settings Per Supported Connection Method	
	Cellular or Internet	Standard Telephone*
Spain		
Sweden		
Switzerland		
Thailand		Not available
United Arab Emirates		Not available
United Kingdom		

\* Switch settings for the standard telephone connection method, if available, also work for cellular or internet connection methods.

## Special Instructions if Using the Standard Telephone Connection Method

For more information on setting up the standard telephone connection, see page 43.

### Traveling

If you travel to another country and use a standard telephone to connect to the Clinician Website, you may need to change the country switch settings. Consult your health care provider to learn if you need to change the switch settings when you travel to another country with your Communicator.

### Setting Switches 1-3 for Dial-out or Prefix Number

If you are using a standard telephone connection method to connect to the Clinician Website, and if you need to use a dial-out or prefix number to place an outside telephone call, switches 1-3 need to be changed from the “off” position shown in “Figure 4. Dial-out Number Switch Settings (1-3)” on page 33. (A dial-out number to one of the settings shown in “Figure 4. Dial-out Number Switch Settings (1-3)” on page 33 may be required in a managed care facility or hotel. For example, if you need to dial a “9” before the number when placing a call, “9” is your dial-out number.)

Note that the telephone service in the facility must be analog, not digital, for the standard telephone connection to work. If you are unsure which telephone mode is available, ask the facility or your service provider.

To set your Communicator for a dial-out or prefix number, slide switches 1-3 up or down so that they match the settings for the dial-out number shown in the following figure.



Dial-out  
Number

None

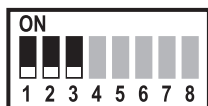

0

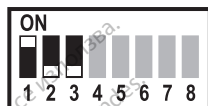

1



7



Dial-out  
Number

8

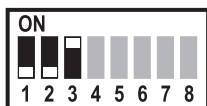

9

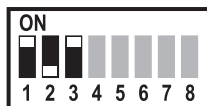

\*99

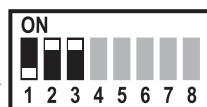

Figure 4. Dial-out Number Switch Settings (1-3)

## Setting Up Your Connection Method

This section explains how to set up a connection method on your Communicator. The connection method enables your Communicator to send your implanted device data to the Clinician Website for access by your health care provider.

Your connection method will be one of the following:

- “Cellular Connection” on page 35
- “Internet Connection” on page 40
- “Standard Telephone Connection” on page 43
- “Hotspot Connection (Mobile Device)” on page 47

Even though all connection method options are described in this section, local limitations may impact availability.

The following figure shows the Status button and all the connectors on the back of your Communicator. Use this figure for reference as you follow this manual’s instructions for setting up your Communicator with a connection method.

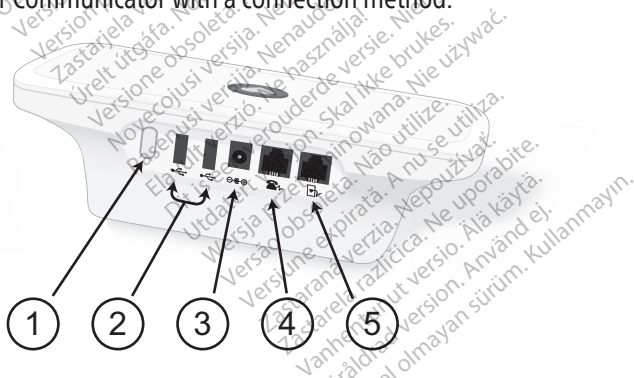

(1) Status button; (2) USB ports, used for optional accessories and cellular or internet connections; (3) Power input; (4) Port to connect an optional telephone (if using a standard telephone connection); (5) Telephone jack used for a standard telephone connection

Figure 5. Back of Communicator

## Cellular Connection

When using the cellular connection method, do not use another connection method, such as standard telephone, internet, or hotspot.

The cellular connection only sends data; it does not send voice signals. It is completely separate and cannot be used with your cell phone.

Your cellular connection may be affected by such things as terrain, weather, foliage, buildings and other construction, signal strength, customer equipment, and other factors.

Complete the following steps to set up your Communicator with a cellular connection to send your data to the Clinician Website. The numbers in Figure 6 refer to the corresponding steps.

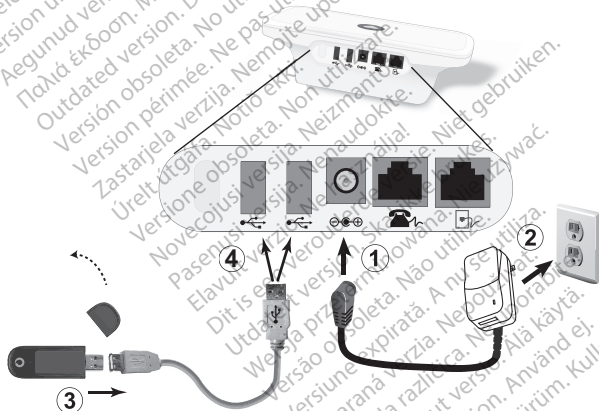



Figure 6. Connecting a USB Cellular Adapter

When using the cellular connection method:

- Place your Communicator in a location where you will get a good cellular signal.
- Place your USB cellular adapter away from electronic products or metal surfaces, and place it alongside the Communicator, not under or on top of it.
- Maintain a distance of at least 15 cm (6 in) between the USB cellular adapter and your implanted device.

Refer to "Figure 6. Connecting a USB Cellular Adapter" on page 35 for depiction of steps 1-4.

1. Insert the power supply (included) into the jack labeled .
2. Plug the power supply into an electrical outlet that is easily accessible.
  - The LATITUDE indicator will flash yellow for up to 1 minute.
  - All the Communicator indicators will light for approximately 1 second.
  - If the LATITUDE indicator is not lit, check that both ends of the power supply are plugged in firmly. Check if the light on the power supply is lit.
3. If the USB cellular adapter has a cap, remove it. Connect the adapter to the provided USB cable extension.
4. Insert the USB connector of the cable extension into one of the USB ports labeled  on the back of your Communicator.

- The LED light on the USB cellular adapter will blink and remain blinking. At times the light may be lit solid. Different light colors are normal. The light will be off when collecting data from your implanted device and during a LATITUDE System reboot.
- A SIM card specific for Communicator use only has been pre-installed in the USB cellular adapter. Do not remove or tamper with this SIM card.

5.  When the Heart button flashes on your Communicator, press it.

- Your Communicator's wave lights will flash green in sequence and repeat for several minutes as shown in "Using the Heart Button" on page 16.
- If this process takes longer than several minutes, software download and installation may be occurring. If the Heart button flashes again, press it again. Refer to "Software Download and Installation" on page 49.
- If you have previously completed initial setup, the Heart button will not flash at this point. Instead of pressing the Heart button, follow the instructions for pressing the Status button in "Confirming Connection to the Clinician Website" on page 20.

6. Your Communicator has successfully connected to the Clinician Website if the lights are lit as shown as follows.



You can verify the cellular connection by following the instructions in “Confirming Connection to the Clinician Website” on page 20. If you travel to another location with your Communicator, verify the connection from that location.

Setup is complete, and no further action is needed at this time. Leave your Communicator plugged in.

- If the wave lights are not lit a solid green, refer to the applicable error in the Troubleshooting section starting on page 51.
- If the Sending Waves light yellow, it may indicate the connection failed. Refer to the Sending Waves sections of “Troubleshooting” starting on page 67. If your Communicator is still unable to connect, contact your health care provider for assistance.

*When using the cellular connection method, keep your Communicator plugged in to the electrical outlet and connected to the USB cellular adapter.*

### Using Previous Cellular Connection Accessories

If you have a Model 6296 USB cellular adapter from a previous Communicator, you may continue to use it for cellular connection to the Clinician Website.

If you have a Multi-Tech Systems MultiConnect™ MT200A2W analog-to-wireless cellular converter from a previous Communicator, you may continue to use it for cellular connection to the Clinician Website. The MultiConnect converter has been tested and found to be compatible with the LATITUDE Communicator.

## Replacement

If you need a replacement USB cellular adapter or a different connection accessory (standard telephone, internet, or hotspot), contact your health care provider.

For information on returning, replacing, or disposing of your USB cellular adapter, see page 23.

If you wish to discontinue using your USB cellular adapter, contact your health care provider.

Остаряла версия. Да не се използва.  
Zastaralá verze. Nepoužívat.  
Forældet version. Må ikke anvendes.  
Version überholt. Nicht verwenden.  
Aegunud versioon. Ärge kasutage.  
Παλιά έκδοση. Μην την χρησιμοποιείτε.  
Outdated version. Do not use.  
Version obsolete. No utilizar.  
Version périmée. Ne pas utiliser.  
Zastarjela verzija. Neizkoristovati.  
Úreilt útgáfa. Notið ekki.  
Versione obsoleta. Nemojite upotrebljavati.  
Novocojusi versija. Non utilizzate.  
Pasenusi versija. Nenaudokite.  
Elavult verzió. Ne használja!  
Dit is een verouderde versie. Niet gebruiken.  
Wersja przeterminowana. Nie używać.  
Versão obsoleta. Não utilize.  
Versione expirată. A nu se utiliza.  
Zastarana verzija. Nepoužívat.  
Zastarela različica. Ne uporabite.  
Vanhentunut versio. Älä käytä.  
Föräldrad version. Använd ej.  
Güncel olmayan sürüm. Kullanmayın.

## Internet Connection

*When using the internet connection method, do not use another connection method, such as standard telephone, cellular, or hotspot.*

Complete the following steps to set up your Communicator with an internet connection to send your data to the Clinician Website. The numbers in Figure 7 refer to the corresponding steps.

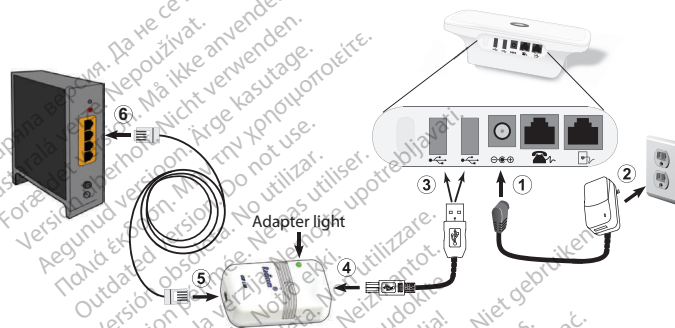

**Figure 7. Connecting a USB Ethernet Adapter**

*When using the internet connection method, place your Communicator near, but no closer than 1 m (3 ft), to an internet modem or router.*



Refer to "Figure 7. Connecting a USB Ethernet Adapter" for depiction of steps 1-6.

1. Insert the power supply (included) into the jack labeled  $\ominus \oplus$ .
2. Plug the power supply into an electrical outlet that is easily accessible.



- The LATITUDE indicator will flash yellow for up to 1 minute.
- All the Communicator indicators will light for approximately 1 second.
- If the LATITUDE indicator is not lit, check that both ends of the power supply are plugged in firmly. Check if the light on the power supply is lit.

*For the following steps, make sure you use the Ethernet cable provided with the USB Ethernet adapter and not the telephone cable provided with the Communicator.*

3. Insert the standard (rectangular) end of the USB cable (included with the USB Ethernet adapter) into one of the USB ports on the Communicator labeled .
4. Insert the square end of the USB cable into the end of the USB Ethernet adapter nearest the adapter light.
5. Insert the Ethernet cable (included with the USB Ethernet adapter) into the opposite end of the adapter.
6. Plug the Ethernet cable into an Ethernet port for your internet service, such as a modem, router, or Ethernet wall jack.
  - The USB Ethernet adapter is properly connected if the green light on the front of the USB Ethernet adapter is lit (solid or flashing).
7.  When the Heart button flashes on the Communicator, press it.
  - Your Communicator's wave lights will flash green in sequence and repeat for several minutes as shown in "Using the Heart Button" on page 16.

- If this process takes longer than several minutes, software download and installation may be occurring. If the Heart button flashes again, press it again. Refer to “Software Download and Installation” on page 49.
  - If you have previously completed initial setup, the Heart button will not flash at this point. Instead of pressing the Heart button, follow the instructions for pressing the Status button in “Confirming Connection to the Clinician Website” on page 20.
8. Your Communicator has successfully connected to the Clinician Website if the lights are lit as shown as follows.



Setup is complete, and no further action is needed at this time. Leave your Communicator plugged in.

- If the wave lights are not lit a solid green, refer to the applicable error in the Troubleshooting section starting on page 51.

*When using the internet connection method, keep your Communicator plugged in to the electrical outlet and connected to the USB Ethernet adapter.*

## Replacement

If you need a replacement internet connection accessory or a different connection method (standard telephone, cellular, or hotspot), contact your health care provider.

For information on returning, replacing, or disposing of your internet connection accessory, see page 23.

# Standard Telephone Connection

When using the standard telephone connection method, do not use another connection method, such as cellular, internet, or hotspot.

Complete the following steps to set up your Communicator with a standard telephone connection to send your data to the Clinician Website. The numbers in Figure 8 refer to the corresponding steps.

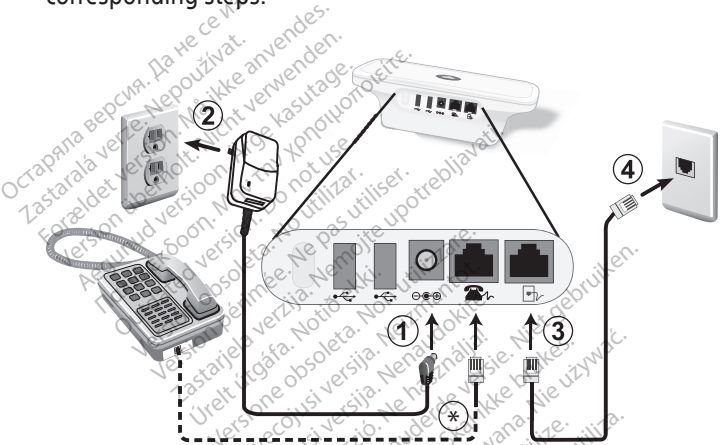



\* Connecting a telephone to your Communicator is optional. To do so, plug your telephone into the jack labeled  or into a telephone jack adapter. Your Communicator and a telephone can share the same telephone wall jack. However, they cannot be used at the same time.

Figure 8. Connecting a Telephone Cable

When using the standard telephone connection, place your Communicator near a telephone wall jack.

Refer to "Figure 8. Connecting a Telephone Cable" for depiction of steps 1-4.

1. Insert the power supply (included) into the jack labeled .

2. Plug the power supply into an electrical outlet that is easily accessible.
  - The LATITUDE indicator will flash yellow for up to 1 minute.
  - All the Communicator indicators will light for approximately 1 second.
  - If the LATITUDE indicator is not lit, check that both ends of the power supply are plugged in firmly. Check if the light on the power supply is lit.

3. Plug one end of the Communicator telephone cable into the jack labeled .

4. You may need to use a telephone jack adapter. If you do, plug the other end of the telephone cable into the telephone jack adapter. Then plug the other end of the cable into the telephone jack on the wall.

**Note:** If you have DSL internet service, you may need to use a DSL filter between the telephone wall jack and the Communicator. Refer to “DSL Internet Service” on page 47.

5.  When the Heart button flashes on your Communicator, press it.
  - Your Communicator’s wave lights will flash green in sequence and repeat for several minutes as shown in “Using the Heart Button” on page 16.
  - If this process takes longer than several minutes, software download and installation may be occurring. If the Heart button flashes again, press it again. Refer to “Software Download and Installation” on page 49.

- If you have previously completed initial setup, the Heart button will not flash at this point. Instead of pressing the Heart button, follow the instructions for pressing the Status button in “Confirming Connection to the Clinician Website” on page 20.
6. Your Communicator has successfully connected to the Clinician Website if the lights are lit as shown as follows.



Setup is complete, and no further action is needed at this time. Leave your Communicator plugged in.

- If the wave lights are not lit a solid green, refer to the applicable error in the Troubleshooting section starting on page 51.

*When using the standard telephone connection, keep your Communicator plugged in to the electrical outlet and connected to the telephone wall jack.*

## Communicator Use of the Telephone

When using a standard telephone connection, the Communicator uses your phone line to make telephone calls to send your data to the Clinician Website. These calls last approximately 5 minutes.

The Communicator can only make outgoing calls. It cannot receive calls.

The Communicator is designed to operate on standard telephone connections like those found in most homes and supports tone dialing over an analog line. The Communicator may work on other telephone systems, such as DSL and VoIP, if

those systems provide an analog interface for connecting the Communicator. The Communicator should not be connected to a digital phone interface, such as those commonly used in some businesses, hotels, and managed care facilities (nursing homes, skilled care facilities, rehabilitation centers) where telephones are typically provided by the facility. If you are unsure of the features on your telephone, ask your service provider.

If you are using the phone line ("Using the Telephone While the Communicator is Making a Call" on page 46), the Communicator will wait and attempt to place a call later. Or if you have other telephone equipment (including fax machine, answering system or computer modem) connected to the same phone line and the line is in use, the Communicator will wait and attempt to place a call later. If you have heavy phone line usage that delays or prevents the Communicator from placing or completing phone calls, it may be appropriate to install an additional telephone line.

Your Communicator and a telephone can share the same telephone wall jack; however, they cannot be used at the same time. The Communicator will relinquish control of the telephone line shortly after you pick up the phone, provided that the telephone line meets the specifications stated on page 80.

### Using the Telephone While the Communicator is Making a Call

If you pick up the phone while the Communicator is using the telephone line, there will be no dial tone. Hang up the receiver, wait **3 or more seconds**, and then pick up the telephone receiver again. The Communicator should disconnect and dial tone will be restored.

If the Communicator does not disconnect and restore dial tone, hang up the receiver. Then unplug the Communicator from electrical power. You can then use your phone. Plug the Communicator back in after you have finished using the phone.

The Communicator will attempt to reconnect later.

## DSL Internet Service

If you have digital subscriber line (DSL) internet service provided through your telephone line, you may need to install a DSL filter between the wall phone jack and the LATITUDE Communicator.

Most DSL filters are small rectangular devices with standard telephone jack connectors at each end. These filters are typically provided by DSL service providers to connect telephones, an answering machine, or a fax machine to your telephone line.

If you use DSL filters for such devices, you will need to install a DSL filter to use the Communicator. If you use a dual-port DSL filter, connect the Communicator to the port labeled PHONE or where you would typically connect a telephone. For assistance, contact your DSL service provider.

### Replacement

If you need a replacement telephone cable or a different connection accessory (cellular, internet, or hotspot), contact your health care provider.

For information on returning, replacing, or disposing of your telephone cable, see page 23.

### Hotspot Connection (Mobile Device)

The hotspot feature on your mobile device may be used for a wireless connection to the Clinician Website.

To use hotspot, you must have the USB accessory adapter plugged into your Communicator. (See the following section, "USB Accessory Adapter Connection.") The pairing PIN number is "123456". Enable hotspot and *Bluetooth*® on your mobile device while near your Communicator for at least **1 hour** each day and for manual device interrogations. This allows enough time for the Communicator to contact the LATITUDE System. You may incur charges from your mobile phone network provider. For assistance, contact your mobile device service provider.

## USB Accessory Adapter Connection

(This adapter is not available in all locations. Contact your health care provider for more information.)

The USB accessory adapter is used to establish a wireless connection between the prescribed weight scale and blood pressure monitor and your Communicator.

The USB accessory adapter may also be used to connect your Communicator to the Clinician Website using a hotspot connection, as described in "Hotspot Connection (Mobile Device)" on page 47.



**Figure 9. Connecting a USB Accessory Adapter**

Plug the USB accessory adapter into either of the USB ports labeled  on the back of the Communicator.

*Leave the USB accessory adapter plugged into the Communicator so it can receive data when you use your prescribed weight scale or blood pressure monitor. The USB accessory adapter also must stay plugged into your Communicator if you are using a hotspot connection to the Clinician Website.*

**Note:** If your Communicator is already using a USB accessory adapter for hotspot connection to the Clinician Website, it can remain connected and will also be used for the weight scale and blood pressure monitor. Only one USB accessory adapter is required.



## Software Download and Installation

Updated software may occasionally be made available to your Communicator for download and installation.

**During initial Communicator setup:** If a software update is waiting, pressing the Heart button will trigger the download and installation process, which could take an additional several minutes. Wait for the Heart button to flash again, then press it. Follow the remaining setup steps for the connection method you are using.

**During normal use, with Communicator already set up:**

Software download and installation may happen without your knowledge. No action is required.

Остаряла версия. Да не се използва.  
Zastaralá verze. Nepoužívat.  
Forældet version. Må ikke anvendes.  
Version überholt. Nicht verwenden.  
Aegunud versioon. Ärge kasutage.  
Παλιά έκδοση. Μην την χρησιμοποιείτε.  
Outdated version. Do not use.  
Version périmée. Ne pas utiliser.  
Zastarjela verzija. Neizkoristovati.  
Úrejt útgáfa. Notið ekki.  
Versione obsoleta. Nemojete upotrebljavati.  
Novecojsi versija. Non utilizzate.  
Pasenusi verzija. Neizmantot.  
Elavult verzió. Ne használja!  
Dit is een verouderde versie. Niet gebruiken.  
Wersja przeterminowana. Nie używać.  
Versão obsoleta. Não utilize.  
Versione expirată. A nu se utiliza.  
Zastarana verzija. Nepoužívat.  
Zastarela različica. Ne uporabite.  
Vanhentunut versio. Älä käytä.  
Föräldrad version. Använd ej.  
Güncel olmayan sürüm. Kullanmayın.

# TROUBLESHOOTING

---

## Overview

This Troubleshooting section first shows various combinations of indicator lights that signal an error, and then shows Yellow Wave light errors.

A description of the issues, actions to take, and verification steps, as applicable, are shown for each type of error.

For clarity, only the pertinent error colors are shown in the images in this Troubleshooting section. A white Heart in the Heart button means it is lit; a gray Heart means it is not lit.

*If none of the steps in this Troubleshooting section work to resolve the error, try resetting your Communicator by unplugging it from the electrical outlet, waiting **1 minute**, then plugging it back in.*

## Indicator Light Errors

◇ Heart Button is Flashing

◇ LATITUDE Indicator is Green

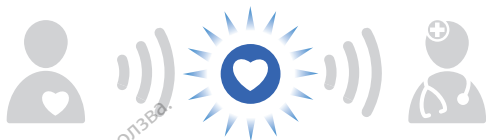

### Issue:

You need to complete a scheduled interrogation or perform a manual device check.

### Action:

Press the Heart button to complete setup or the interrogation. Refer to “Using the Heart Button” on page 16 for the light sequence when the Heart button is pressed.

### Verify:

- After pressing the Heart button, if the indicators are lit as shown below, the interrogation or device check was successful.



- If the indicators are not lit as shown above, refer to the applicable error in the Yellow Wave Errors section starting on page 60.

## ◇ No Indicators are Lit



LATITUDE™



### Issue:

- The Communicator is not connected to electrical power or it is not functioning.
- The Communicator has just been plugged into electrical power or may be downloading and installing software. This process typically lasts 5 minutes but may take longer.

### Action:

- Check that both ends of the power supply are plugged in firmly.
- Check if the light on the power supply is lit. Make sure the electric outlet is active, or try a different outlet.
- Unplug the power supply from both the wall outlet and the Communicator for **1 minute**. After 1 minute, reconnect the power supply to both. Lights will flash during the transition.
- If the above actions do not resolve the issue, wait **5 minutes** for a possible software update to complete.

## Verify:

- If indicator lights flash, and then you get a solid green LATITUDE indicator as shown below, the issue is resolved.



LATITUDE™



- If all indicators are still unlit, including the LATITUDE indicator, contact your health care provider.

- ◇ LATITUDE Indicator is Flashing Yellow
- ◇ No Other Indicators are Lit



LATITUDE™



**Issue:**

The Communicator has just been plugged into electrical power or may be downloading and installing software. This process typically lasts 5 minutes but may take longer.

**Action:**

Wait **5 minutes** for a possible software update to complete.

**Verify:**

- If indicator lights flash, and then you get a solid green LATITUDE indicator as shown below, the issue is resolved.



- If the LATITUDE indicator is still flashing yellow, contact your health care provider.

- ◇ Call Doctor Icon is Red (Flashing or Solid)
- ◇ LATITUDE Indicator is Yellow



LATITUDE™



### Issue:

- A potential problem with your implanted device was detected, but the Communicator cannot send any information collected from your implanted device to the Clinician Website.
- The Call Doctor icon and LATITUDE indicator will remain lit solid as shown until the problem is resolved.

**Action:** Your immediate response is required. Call your health care provider.



◇ Call Doctor Icon is Yellow (Flashing or Solid)

◇ LATITUDE Indicator is Yellow



LATITUDE™



**Issue:**

- This indicates one of the following errors:
- Your Communicator is currently unable to read your implanted device or send its data to the Clinician Website.
- Monitoring of your implanted device was suspended.
- The Call Doctor icon and LATITUDE indicator will remain lit solid yellow as shown until the problem is resolved.

**Action:**

Unplug the power supply from both the wall outlet and the Communicator for **1 minute**. After 1 minute, reconnect the power supply to both. Lights will flash during the transition.

**Verify:**

- If successful, the LATITUDE indicator will light green as shown below.



- If the Call Doctor icon and LATITUDE indicator remain yellow, contact your health care provider.

Остаряла версия. Да не се използва.  
Zastaralá verze. Nepoužívat.  
Forældet version. Må ikke anvendes.  
Version überholt. Nicht verwenden.  
Aegunud versioon. Ärge kasutage.  
Παλιά έκδοση. Μην την χρησιμοποιείτε.  
Outdated version. Do not use.  
Version obsolete. No utilizar.  
Version périmée. Ne pas utiliser.  
Zastarjela verzija. Nemojte upotrebljavati.  
Úreilt útgáfa. Notið ekki.  
Versione obsoleta. Non utilizzare.  
Novecojsi versija. Neizmantot.  
Pasenusi verzija. Nenaudokite.  
Elavult verzió. Ne használja!  
Dit is een verouderde versie. Niet gebruiken.  
Utdatert versjon. Skal ikke brukes.  
Wersja przeterminowana. Nie używać.  
Versão obsoleta. Não utilize.  
Zastarana verzija. Nepoužívat.  
Zastarela različica. Ne uporabite.  
Vanhentunut versio. Älä käytä.  
Föråldrad version. Använd ej.  
Güncel olmayan sürüm. Kullanmayın.

◇ Call Doctor Icon is Solid Yellow

◇ LATITUDE Indicator is Not Lit



LATITUDE™



**Issue:** This indicates your Communicator is having a problem connecting.

**Action:** Unplug the power supply from both the wall outlet and the Communicator for **1 minute**. After 1 minute, reconnect the power supply to both. Lights will flash during the transition.

**Verify:**

- If successful, the LATITUDE indicator will light green as shown below.



- If the Call Doctor icon remains yellow, you may need a replacement Communicator. Contact your health care provider.

## Yellow Wave Errors

Yellow Wave light errors stay lit for 60 minutes unless the error is resolved sooner. The LATITUDE indicator is lit yellow at the same time. After 60 minutes, all wave lights are turned off and the LATITUDE indicator is lit green, even if the problem was not resolved.

If you suspect the Yellow Wave light errors are still an issue after the wave lights are turned off, press the Status button for **1 second** as explained in “Status Button” on page 19 to verify the error. Then refer to the applicable Yellow Wave error in this section.

## One Yellow Collecting Wave



**Issue:** The Communicator was unable to start an interrogation of your implanted device, or your implanted device was out of range at the time of the attempted interrogation.

- Action:**
- Ensure the Communicator is optimally placed as described in “Where to Place Your Communicator” on page 8.
  - Face the Communicator. Sit directly in front of the Communicator. Make sure you are within 1 m (3 ft) of the Communicator.
  - Move any wireless electronic products (such as cordless or cellular phones, baby monitors, or modems/routers) at least 1 m (3 ft) away from the Communicator.
  - Press the Heart button to start another interrogation. Refer to “Using the Heart Button” on page 16 for the light sequence when the Heart button is pressed.

**Verify:**

- If the indicators are lit as shown below, the interrogation was a success.



LATITUDE™

- If one Yellow Collecting Wave remains, contact your health care provider.
- If other Yellow Wave errors remain, refer to the applicable error in this section.

## Two Yellow Collecting Waves



**Issue:** The Communicator started but was not able to complete the interrogation within the time allowed.

- Action:**
- Ensure the Communicator is optimally placed as described in “Where to Place Your Communicator” on page 8.
  - Face the Communicator. Sit directly in front of the Communicator. Make sure you are within 1 m (3 ft) of the Communicator.
  - Remain still until the interrogation is complete, as shown in the Verify section on page 64. Do not move away from the Communicator.
  - Move any wireless electronic products (such as cordless or cellular phones, baby monitors, or modems/routers) at least 1 m (3 ft) away from the Communicator.
  - Press the Heart button to start another interrogation. Refer to “Using the Heart Button” on page 16 for the light sequence when the Heart button is pressed.

**Verify:**

- If the indicators are lit as shown below, the interrogation was a success.



LATITUDE™

- If two Yellow Collecting Waves remain, contact your health care provider.
- If other Yellow Wave errors remain, refer to the applicable error in this section.



## ◇ Three Yellow Collecting Waves



**Issue:** One of the following reasons could cause this error:

- You may have exceeded your weekly interrogation limit, or you may not be allowed to use the Heart button.
- You may be sitting too close to your modem/router.

**Action:**

- If you suspect you may have exceeded your weekly interrogation limit or are not allowed to use the Heart button, contact your health care provider.

- Move at least 1 m (3 ft) away from your modem/router.
- Press the Heart button to start another interrogation. Refer to "Using the Heart Button" on page 16 for the light sequence when the Heart button is pressed.

**Verify:**

- If the indicators are lit as shown below, the interrogation was a success.



LATITUDE™

- If three Yellow Collecting Waves remain, contact your health care provider.
- If other Yellow Wave errors remain, refer to the applicable error in this section.

## ◊ One Yellow Sending Wave



**Issue:** An attempt to connect to the Clinician Website failed due to issues relating to the cellular, internet, or telephone connection.

**Action if using a cellular connection:**

- Make sure the USB cellular adapter is plugged into the Communicator.
- Unplug the Communicator from the electrical outlet, wait **1 minute**, then plug it back in.
- Move the Communicator to another location that may have better cellular reception.
- Press the Status button for **3 seconds** as explained in “Confirming Connection to the Clinician Website” on page 20. Then proceed to the Verify section on page 69.

## Action if using an internet connection:

- Make sure the USB cable provided with the USB Ethernet adapter is connected at one end to the USB Ethernet adapter and at the other end to the USB port on the back of the Communicator.
- Make sure the Ethernet cable provided with the USB Ethernet adapter is firmly connected at one end to the USB Ethernet adapter and at the other end to the Ethernet port for your internet service.
- If the green light on the front of the USB Ethernet adapter is not on, make sure the internet modem or router is powered on.
- Press the Status button for **3 seconds** as explained in "Confirming Connection to the Clinician Website" on page 20. Then proceed to the Verify section on page 69.

### Action if using a standard telephone connection:

- Check that the telephone cable is plugged in tightly to a telephone wall jack and the Communicator.
- Pick up the telephone that is using the same telephone wall jack as the Communicator, and check for dial tone. If no dial tone, try a different telephone wall jack.
- If you have DSL internet service, ensure you are using a DSL filter between the Communicator and the telephone wall jack.
- Check that the analog telephone service supports the tone dialing mode.
- Press the Status button for **3 seconds** as explained in "Confirming Connection to the Clinician Website" on page 20. Then proceed to the Verify section on page 69.

### Verify (all connection types):

- If the connection was a success, the indicators will be lit as shown below.



- If one Yellow Sending Wave remains, contact your health care provider.
- If other Yellow Wave errors remain, refer to the applicable error in this section.

## ◇ Two Yellow Sending Waves



**Issue:** An attempt to connect to the Clinician Website failed due to issues relating to the cellular, internet, or telephone connection.

**Action if using a cellular connection:**

- Move the Communicator to another location that may provide a stronger cellular signal.
- Press the Status button for **3 seconds** as explained in “Confirming Connection to the Clinician Website” on page 20. Then proceed to the Verify section on page 72.

**Action if using an internet connection:**

- Make sure the Ethernet cable provided with the USB Ethernet adapter is connected to the Ethernet port for your internet service.
- Press the Status button for **3 seconds** as explained in “Confirming Connection to the Clinician Website” on page 20. Then proceed to the Verify section on page 72.

**Action if using a standard telephone connection:**

- Make sure your telephone is not being used at this time.
- Pick up the telephone that is using the same telephone wall jack as the Communicator, and check for dial tone. If no dial tone, try a different telephone wall jack.
- Remove any splitters between the Communicator and the telephone wall jack.
- If you have DSL internet service, ensure you are using a DSL filter between the Communicator and the telephone wall jack.
- Check that the switches on the bottom of the Communicator are set correctly for your country and whether you need to dial a number to get an outside line. Refer to “Confirming/Setting Switch Settings” on page 26.
- Press the Status button for **3 seconds** as explained in “Confirming Connection to the Clinician Website” on page 20. Then proceed to the Verify section on page 72.

## Verify (all connection types):

- If the connection was a success, the indicators will be lit as shown below.



LATITUDE™

- If two Yellow Sending Waves remain, contact your health care provider.
- If other Yellow Wave errors remain, refer to the applicable error in this section.



## ◇ Three Yellow Sending Waves



### Issue:

The Communicator was able to establish a connection to the Clinician Website, but no information reached it.

### Action for any type of connection:

Check that the switches on the bottom of the Communicator are set correctly for your country and whether you need to dial a number to get an outside line. Refer to “Confirming/Setting Switch Settings” on page 26.

### Action if using an internet connection:

Make sure that other computers or devices connected to your internet modem or router are able to access the internet.

### Verify (all connection types):

- If the connection was a success, the indicators will be lit as shown below.



- If three Yellow Sending Waves remain, contact your health care provider.
- If other Yellow Wave errors remain, refer to the applicable error in this section.

Остаряла версия. Да не се използва.  
Zastaralá verze. Nepoužívat.  
Forældet version. Må ikke anvendes.  
Version überholt. Nicht verwenden.  
Aegunud versioon. Ärge kasutage.  
Παλιά έκδοση. Μην την χρησιμοποιείτε.  
Outdated version. Do not use.  
Version périmée. Ne pas utiliser.  
Zastarjela verzija. Neizmantovati.  
Úrejt útgáfa. Notið ekki.  
Versione obsoleta. Nemojete upotrebljavati.  
Novacijosi versija. Non utilizzare.  
Pasenusi verzija. Neizmantot.  
Elavult verzió. Ne használja!  
Dit is een verouderde versie. Niet gebruiken.  
Wersja przeterminowana. Nie używać.  
Versão obsoleta. Não utilize.  
Versione expirată. A nu se utiliza.  
Zastarana verzija. Nepoužívat.  
Zastarela različica. Ne uporabite.  
Vanhentunut versio. Älä käytä.  
Föräldrad version. Använd ej.  
Güncel olmayan sürüm. Kullanmayın.

## ADDITIONAL INFORMATION

### LATITUDE Support

Your implanted device and the LATITUDE Communicator are manufactured by Boston Scientific. In certain instances, your health care provider may instruct you to contact Boston Scientific for help with your Communicator. When instructed to contact Boston Scientific, call the applicable telephone number from the following list.

Australia	1800 528 488
Austria	0800 202289
Belgium	0800 80697
Czech Republic	239 016 657
Denmark	70 10 01 82
Finland	010 80 48 19
France	0805 5404 22
Germany	069 51709 481
Greece	442 035 647 788
Hong Kong	852 8105 5433
Hungary	06 80 981 579
Iceland	8004174
Ireland (Republic)	1890 812005
Italy	848 781164
Kuwait	22089688
Lebanon	+961 1 956 777
Malaysia	(603) 7808 8000
Netherlands	0800 0292077
New Zealand	0508 200 886

Norway	81 00 00 47
Poland	22 306 07 33
Portugal	800844729
Qatar	800 6520
Saudi Arabia	1 800 844 8246
Singapore	18006224909
Slovak Republic	02 686 223 89
South Africa	800228000
South Korea	+82-2-3483-1782
Spain	901-010840
Sweden	020 160 57 07
Switzerland	0844 000110
Thailand	1800012420
United Arab Emirates	800035770015
United Kingdom	0800 678 16 44

Report any serious incident that occurs in relation to your device to Boston Scientific and to the relevant local regulatory authority for medical devices in your country.

For customers in Australia, report any serious incident that occurs in relation to your device to Boston Scientific and to the Therapeutic Goods Administration (<https://www.tga.gov.au>).

## Frequently Asked Questions

These FAQs are designed to point you to the right section in this manual for the answers.

### What should I do if the Heart button is flashing?

Press the Heart button to complete a scheduled interrogation. A flashing Heart button does not indicate there is a problem with your implanted device. Refer to “Using the Heart Button” on page 16.

### Does the Communicator call emergency services in an emergency?

No. The LATITUDE System is not meant to assist with health emergencies. If you are not feeling well or need urgent health care, call your health care provider or your local emergency service. Refer to “About the LATITUDE Patient Management System” on page 1.

### Where should I place my Communicator?

Refer to “Where to Place Your Communicator” on page 8.

### How do I set up my Communicator using a USB cellular adapter?

Refer to “Cellular Connection” on page 35.

### How do I set up my Communicator using a USB Ethernet adapter?

Refer to “Internet Connection” on page 40.

### How do I set up my Communicator using a standard telephone connection?





Refer to “Standard Telephone Connection” on page 43.

## How do I know the Communicator is working?

Refer to “Heart Button and Indicator Descriptions” on page 11 and “Normal Operation of the Communicator” on page 16.

## What do these lights mean?

See the following chart, and refer to “Heart Button and Indicators” on page 9 or the Troubleshooting section starting on page 51.

If you see ...	It means ...	Do this ...
	The Communicator needs help completing a scheduled device check. <b>Note:</b> This does not indicate a problem with your implanted device.	Press the Heart button.  Stay next to the Communicator until all lights are as shown in the next row.
	Data from your implanted device has been sent to the Clinician Website.	No further action required.
	There is a potential problem that needs to be addressed by your health care provider.	Call your health care provider.
	Any Yellow Wave or Yellow Call Doctor icon means your Communicator is having a problem connecting or monitoring has been suspended.	Refer to the applicable error in the Troubleshooting section starting on page 51.

## How do I manually send my data?

Refer to “Using the Heart Button” on page 16.

## When do I use my Communicator?

Refer to “The LATITUDE Communicator” on page 2 and “Using the Heart Button” on page 16.

## What do I need to do with my Communicator if I travel?

Refer to “Traveling With Your Communicator” on page 21.

## How do I dispose of my Communicator and Accessories?

Refer to “Returning, Replacing, or Disposing of the Communicator or Accessories” on page 23.

## Where can I go for more help?

Contact your health care provider.

# Specifications

Model:	6288 and 6290 (Unless specified, values apply to all models.)
Dimensions:	Length: 20.3 cm (8.00 in) Width: 11.4 cm (4.50 in) Height: 6.9 cm (2.71 in)
Weight:	0.38 kg (0.83 lbs)
Power Source (included):	5.0 VDC, 3.0 A, continuous service Class II AC adapter (power supply): <i>Model 6288:</i> GlobTek™ GTM41061-1512-7.0 <i>Model 6290:</i> GlobTek™ GTM41061-1512-7.0 or SL Power Electronics™: AUS/NZL: MENB1020A0540H02 Europe (except GBR/IRL): MENB1020A0540M02 GBR/HKG/IRL/SAU: MENB1020A0540G02
Power Supply Input:	100-240 VAC, 0.6 A, 50-60 Hz
Maximum Output:	15 W
Supply Mains Isolation:	AC adapter (power supply) plug
Protection against electric shock:	Class II
Minimum Operational Loop Current:	20 mA
Expected Service Life:	Up to 15 years
Safety Classification of Ports	RJ-11 ports: TNV-3 circuit USB ports: SELV circuit
Short Range Device (SRD) Receiver ( <i>Model 6288 only</i> ):	Category 2
Analog Dialing Mode:	Tone
Operating Temperature:	5°C to 40°C (41°F to 104°F)



Storage and Transport Temperature*:	-25°C to 70°C (-13°F to 158°F)
Operating Humidity:	15% to 93% noncondensing
Storage and Transport Humidity*:	Up to 93% noncondensing
Operating Pressure:	70 to 106 kPa
Storage and Transport Pressure*:	50 to 106 kPa
Protection Against Ingress of Solid Foreign Objects:	IP21 ( $\geq 12.5$ mm diameter)
Protection Against Ingress of Water:	IP21 (light rain proof)

\* Storage and transport specifications apply with or without Communicator protective packaging.

#### Communicator Implanted Device Radio (Model 6288 ISM Radio Band for Australia/New Zealand):

Receive Bandwidth:	+190/-160 kHz
Frequency Band:	916.5 MHz
Modulation Transmit Type:	ASK (Amplitude-Shift Keying)
Effective Radiated Power:	$\leq 1.25$ dBm (0.75 mW)
Antenna Type:	Monopole
Antenna Gain:	0.3 dBi at 916.5 MHz

#### Communicator Implanted Device Radio (Model 6288 SRD Radio Band for Europe and Saudi Arabia):

Receive Bandwidth:	+150 kHz
Frequency Band:	869.85 MHz
Modulation Transmit Type:	ASK (Amplitude-Shift Keying)
Effective Radiated Power:	$< 2.0$ dBm (1.6 mW)
Antenna Type:	Monopole
Antenna Gain:	2.1 dBi at 869.85 MHz

Communicator Implanted Device Radio  
(Model 6290):

Receive Bandwidth:	<300 kHz
MICS/MedRadio:	402-405 MHz
Modulation Transmit Type:	FSK (Frequency-Shift Keying)
Effective Radiated Power:	<-16 dBm (25 $\mu$ W)
Antenna Type:	Monopole
Antenna Gain:	0.0 dBi at 403.5 MHz

USB Accessory Adapter (if available):

2.4 GHz wireless USB dongle  
Boston Scientific Model 6454  
(included with weight scale and blood pressure monitor;  
may also be available separately)

Operational Frequency:	2400.0 to 2480.0 MHz
Modulation Type:	Adaptive Frequency Hopping
Effective Radiated Power:	+19.4 dBm (87.1 mW)
Operating Temperature:	0°C to 70°C (32°F to 158°F)
Storage and Transport Temperature:	-20°C to 85°C (-4°F to 185°F)
Operating Humidity:	10% to 85% noncondensing
Storage and Transport Humidity:	10% to 85% noncondensing
Antenna Type:	Monopole
Antenna Gain:	2.6 dBi at 2442 MHz

DSL Filter (if supplied):

Digital Subscriber Line (DSL) in-line filter

Excelsus™ Technologies, Inc. - Model Z-200SM

Boston Scientific - Model 6421

DC Loop Current: 20-100 mA DC

## LATITUDE NXT USB Cellular Adapter (Model 6296):

EGSM-900:	TX 880–915 MHz RX 925–960 MHz Effective Radiated Power: 28.7 dBm Antenna Type: Monopole Antenna Gain: 1.7 dBi at 897.4 MHz
DCS-1800:	TX 1710–1785 MHz RX 1805–1880 MHz Effective Radiated Power: 26.7 dBm Antenna Type: Monopole Antenna Gain: 2.2 dBi at 1747.4 MHz
W-CDMA 900:	TX 880–915 MHz RX 925–960 MHz Effective Radiated Power: 18.0 dBm Antenna Type: Monopole Antenna Gain: 1.7 dBi at 897.4 MHz
W-CDMA 2100:	TX 1920–1980 MHz RX 2110–2170 MHz Effective Radiated Power: 18.4 dBm Antenna Type: Monopole Antenna Gain: 1.8 dBi at 1949.9 MHz

## Network and Connectivity Specifications

### Required Characteristics of IT Network

Ethernet:	IEEE 802.3, 10 Mbps IEEE 802.3u, 100 Mbps
Wi-Fi:	None
Hazardous situations resulting from network failure:	The Communicator fails to report a potential problem with the implanted device to the Clinician Website

## Required Configuration of IT Network

Ethernet:	Static IP addressing
Wi-Fi:	None
Ethernet MAC address:	On dongle label
Internet protocol:	IPv4
Dynamic Host Configuration Protocol (DHCP) mode:	Automatic DHCP mode supported
Wi-Fi MAC address:	None

Остаряла версия. Да не се използва.  
Zastaralá verze. Nepoužívat.  
Forældet version. Må ikke anvendes.  
Version überholt. Nicht verwenden.  
Aegunud versioon. Ärge kasutada.  
Παλιά έκδοση. Μην την χρησιμοποιείτε.  
Outdated version. Do not use.  
Version obsolete. Ne utilizar.  
Version périmée. Ne pas utiliser.  
Zastarjela verzija. Neizmantot.  
Úrejt útgáfa. Notið ekki.  
Versione obsolete. Nemojte upotrebljavati.  
Novecojsi versija. Non utilizzate.  
Pasenusi versija. Nenaudokite.  
Elavult verzió. Ne használja.  
Dit is een verouderde versie. Niet gebruiken.  
Wersja przeterminowana. Nie używać.  
Versão obsoleta. Não utilize.  
Versiune expirată. A nu se utilizează.  
Zastarela verzija. Nepoužívat.  
Vanhentunut versio. Älä käytä.  
Föråldrad version. Använd ej.  
Güncel olmayan sürüm. Kullanmayın.

# Safety and Standards Compliance

- Changes or modifications not expressly approved by Boston Scientific could void the user's authority to operate this equipment.
- Allow 10 minutes for the Communicator to return to the ambient temperature (20°C or as applicable) when starting from the storage temperature limits.
- Before each use, visually inspect your Communicator to make sure the housing has no cracks and the AC adapter (power supply) and any other connecting items are intact.
- The use of accessories and cables other than those specified may result in increased emissions or decreased immunity of the LATITUDE Communicator.
- Keep your Communicator and all accessories out of the reach of small children and pets. Small parts may cause choking or serious injury if swallowed and attached cords may pose a strangulation hazard. Consult a health care professional immediately if this occurs.
- Do not insert any object other than a phone connector into the phone jacks on the back of the Communicator. There can be voltage on the electrical contacts in the jacks. There is potential to receive a shock.
- Do not use the Communicator adjacent to or stacked with other equipment. If it is necessary to use the Communicator adjacent to or stacked with other equipment, please contact your health care provider to verify normal operation.
- Do not use the Communicator in the presence of flammable gas mixtures, including anesthetics, oxygen, or nitrous oxide.
- The user is cautioned to maintain a 20 cm (8 in) spacing from the product to ensure compliance with European Norm (EN) or Federal Communications Commission/Industry Canada (FCC/IC) requirements.
- *Model 6288 only:* To help prevent electromagnetic interference, it may be necessary in rare cases to keep other wireless communications equipment such as cellular telephones and their base stations, and wireless home network devices at least 3.3 m (11 ft) away from the Communicator.
- *Model 6290 only:* To help prevent electromagnetic interference, it may be necessary to keep other wireless communications equipment such as cellular telephones and their base stations, and wireless home network devices at least 30 cm (12 in) away from the Communicator.
- Other wireless communication equipment could interfere with the Communicator even if the other equipment complies with CISPR (Special International Committee on Radio Interference) emission requirements.
- Accessory equipment connected to the analog and digital interfaces (signal inputs and signal outputs) must be certified according to the respective EN or IEC standards. Anyone who connects additional equipment to the signal input parts or signal output parts may configure a medical system, and is therefore

responsible that the system complies with the requirements of clause 16 of EN 60601-1:2006+ A1:2013 or IEC 60601-1:2005/A1:2012. If in doubt, consult the technical service department or your local representative.

- This equipment has been tested and found to comply with applicable safety portions of the following standards:
  - IEC 60601-1:2005/A1:2012
  - ANSI/AAMI ES60601-1:2005(R)2012
  - EN 60601-1:2006 + A1:2013
  - CAN/CSA-C22 No. 60601-1:2014
  - IEC 60601-1-11:2015
- This equipment has been tested and found to comply with the applicable limits for Class B medical devices in a professional health care facility or home environment to IEC 60601-1-2:2014. This testing shows the device provides reasonable protection against harmful interference in a typical medical or home installation. However, there is no guarantee that interference will not occur in a particular installation.
- **Australia/New Zealand only:** The grant of a Telepermit for any item of terminal equipment indicates only that Telecom has accepted that the item complies with minimum conditions for connection to its network. It indicates no endorsement of the product by Telecom, nor does it provide any sort of warranty. Above all, it provides no assurance that any item will work correctly in all respects with another item of Telepermitted equipment of a different make or model, nor does it imply that any 101 PTC 200 May 2006 product is compatible with all of Telecom's network services.

*The following apply only to Communicators using a telephone connection accessory (not available in all locations):*

- If your home has specially wired alarm equipment connected to the telephone line, ensure the installation of the Communicator does not disable your alarm equipment. If you have questions about what will disable alarm equipment, consult your telephone company or a qualified installer.
- The telephone company may make changes in its facilities, equipment, operations, or procedures that could affect the operation of the equipment. If this happens, the telephone company will provide advance notice in order for you to make necessary modifications to maintain uninterrupted service. If the equipment is causing harm to the telephone network, the telephone company may request that you disconnect the equipment until the problem is resolved.

# European Union Importer

EU Importer: Boston Scientific International B.V., Vestastraat 6, 6468 EX Kerkrade, The Netherlands.

## Essential Performance

In accordance with clause 4.3 of IEC/EN 60601-1, the Communicator has no performance that qualifies as essential performance.

## Software Statement

The software included in this product contains copyrighted software that is licensed under the GNU General Public License (GPL). Under the terms of the GPL as published by the Free Software Foundation, you may obtain the complete corresponding source code from us for a period of three years after our shipment of this product.

# Electromagnetic Emissions and Immunity

**Table 2. Guidance and manufacturer's declaration—  
electromagnetic compatibility**

The LATITUDE Communicator is suitable for use in a professional health care facility or home environment.		
Test	Compliance	Electromagnetic environment—guidance
Protection of radio services and other equipment	CISPR 11 Group 1 Class B	The LATITUDE Communicator uses RF energy only for its intended uses in communication with the implanted device or connectivity functions. Its RF emissions are very low and are not likely to cause any interference in nearby electronic equipment.
Protection of the public mains network	CISPR 11 Class B IEC 61000-3-2 IEC 61000-3-3	The LATITUDE Communicator is suitable for use in a professional health care facility or home environment.
Electrostatic discharge	± 8 kV contact ± 2 kV, ± 4 kV, ± 8 kV, and ± 15 kV air	
Radiated RF EM field	3 V/m from 80 MHz to 2.7 GHz	
Proximity fields from RF wireless communications equipment	380 - 390 MHz: 27 V/m 430 - 470 MHz: 28 V/m 704 - 787 MHz: 9 V/m 800 - 960 MHz: 28 V/m 1700 - 1900 MHz: 28 V/m 2400 - 2570 MHz: 28 V/m 5100 - 5800 MHz: 9 V/m	
Rated power frequency magnetic field	30 A/m	
Electrical fast transients/ bursts	± 2 kV input AC power ± 1 kV SIP/SOP	
Surges line-to-line	± 0.5 kV, ± 1 kV input AC power	
Surges line-to-ground	± 0.5 kV, ± 1 kV, ± 2 kV input AC power	



























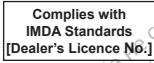

The LATITUDE Communicator is suitable for use in a professional health care facility or home environment.





Test	Compliance	Electromagnetic environment—guidance
Conducted disturbances induced by RF fields	3 V/m from 0.15 MHz to 80 MHz  6 V/m in ISM bands from 0.15 MHz to 80 MHz	The ISM bands between 0.15 MHz and 80 MHz are 6.765 MHz to 6.795 MHz 13.553 MHz to 13.567 MHz 26.957 MHz to 27.283 MHz 40.66 MHz to 40.70 MHz.
		The amateur radio bands between 0.15 MHz and 80 MHz are 1.8 MHz to 2.0 MHz 3.5 MHz to 4.0 MHz 5.3 MHz to 5.4 MHz 7.0 MHz to 7.3 MHz 10.1 MHz to 10.15 MHz 14.0 MHz to 14.2 MHz 18.07 MHz to 18.17 MHz 21.0 MHz to 21.4 MHz 24.89 MHz to 24.99 MHz 28.0 MHz to 29.7 MHz 50.0 MHz to 54.0 MHz.
Voltage dips <sup>a</sup>	0% U <sub>n</sub> for 0.5 cycle at 0°, 45°, 90°, 135°, 180°, 225°, 270°, and 315°  0% U <sub>n</sub> for 1 cycle and 70% U <sub>n</sub> for 25/30 cycles at 0°	
Voltage interruptions <sup>a</sup>	0% U <sub>n</sub> for 250/300 cycles	

a. Voltage dips and interruptions: U<sub>n</sub> is the AC mains voltage prior to application of the test level.

## Explanation of Product and Label Symbols

Symbol	Meaning
	Input from Telephone Jack
	Output to Telephone (optional)
	AC/DC Adapter Power Input
	USB Connection
	Direct Current
	Reference Number
	Solid foreign objects and water protection
	Follow instructions for use
	Class II equipment (IEC 60601)
	Non-ionizing electromagnetic radiation
	Discard with electronic waste
	ACMA compliance mark
<b>R-NZ</b>	New Zealand Radio Spectrum Management (RSM) radio compliance mark
	Representative sample of label that indicates that this device may lawfully be connected to the network in New Zealand

Symbol	Meaning
	Representative sample of label that indicates this product complies with applicable United Arab Emirates telecommunications standards
	Indicates this product complies with applicable South African telecommunications standards
	Representative sample of label that indicates this product complies with applicable Singaporean telecommunications standards
	Indicates this product complies with applicable Malaysian telecommunications standards
	Part Number
	Serial Number
	Date of Manufacture
	Open Here
	Medical Device under EU Legislation
	Manufacturer
	Temperature Limitation
	Humidity Limitation
	Atmospheric Pressure Limitation
	Authorized representative in the European Community

Symbol	Meaning
	Australian sponsor address
	Corrugated recycles
	Consult instructions for use (applies to USB accessory adapter)
	Indicates this product complies with applicable Japanese telecommunications standards (applies to USB accessory adapter)

Остаряла версия. Да не се използва.  
Zastaralá verze. Nepoužívat.  
Forældet version. Må ikke anvendes.  
Version überholt. Nicht verwenden.  
Aegunud versioon. Ärge kasutage.  
Παλιά έκδοση. Μην την χρησιμοποιείτε.  
Outdated version. Do not use.  
Version périmée. Ne pas utiliser.  
Zastarjela verzija. Nemojte upotrebljavati.  
Úrejt útgáfa. Notið ekki.  
Versione obsoleta. Non utilizzare.  
Pasenusi verzija. Neizmantot.  
Zastarjela verzija. Neizmantot.  
Novecojsi versija. Nenaudokite.  
Elavult verzió. Ne használja!  
Dit is een verouderde versie. Niet gebruiken.  
Wersja przeterminowana. Nie używać.  
Versão obsoleta. Não utilize.  
Versione expirată. A nu se utiliza.  
Zastarana verzija. Nepoužívat.  
Zastarela različica. Ne uporabite.  
Vanhentunut versio. Älä käytä.  
Föråldrad version. Använd ej.  
Güncel olmayan sürüm. Kullanmayın.



Boston Scientific Corporation  
4100 Hamline Avenue North  
St. Paul, MN 55112-5798 USA



Guidant Europe NV/SA  
Boston Scientific  
Green Square,  
Lambroekstraat 5D  
1831 Diegem, Belgium  
1.800.CARDIAC (227.3422)  
Worldwide: +1.651.582.4000

[www.bostonscientific.com](http://www.bostonscientific.com)  
[www.bostonscientific.com/patientlabeling](http://www.bostonscientific.com/patientlabeling)



Boston Scientific (Australia) Pty Ltd  
PO Box 332  
BOTANY NSW 1455 Australia  
Free Phone 1 800 676 133  
Free Fax 1 800 836 666

**CE 2797**



92435999-001

en OUS

2020-07

© 2020 Boston Scientific Corporation or its affiliates.  
All rights reserved.