

PHYSICIAN'S LEAD MANUAL

ACUITY™ X4

Coronary Venous

Pace/Sense Lead

IS4 Four-Pole Connector

ACUITY™ X4 Straight

Straight Tip

Tined Fixation

REF 4671, 4672

ACUITY™ X4 Spiral S

Short Tip Spiral

Tined + Spiral Fixation

REF 4674, 4675

ACUITY™ X4 Spiral L

Long Tip Spiral

Tined + Spiral Fixation

REF 4677, 4678

Остаряла версия. Да не се използва.
Zastaralá verze. Nepoužívat.
Forældet version. Må ikke anvendes.
Version überholt. Nicht verwenden.
Version up-to-date. Μην την χρησιμοποιείτε.
Πολύ έκδοση. Μην την χρησιμοποιείτε.
Outdated version. Do not use.
Version obsolete. Ne pas utiliser.
Zastarjela verzija. Nemojte upotrebljavati.
Úrejt utgáfa. Notið ekki.
Versione obsoleta. Non utilizzare.
Novécojusi versija. Nenaudokite.
Pasenusi versija. Neizmantot.
Elavult verzió. Ne használjal.
Dit is een verouderde versie. Niet gebruiken.
Utdatert versjon. Skal ikke brukes.
Wersja przeterminowana. Nie używać.
Versão obsoleta. Não utilize.
Versiune expirată. A nu se utiliza.
Zastaraná verzija. Nepoužívat.
Zastarela različica. Ne uporabite.
Vanhentunut versio. Älä käytä.
Föråldrad version. Använd ej.
Güncel olmayan sürüm. Kullanmayın.

Table of Contents

INFORMATION FOR USE	1
Device Description	1
Related Information	3
MR Conditional System Information	3
Indications and Usage	4
Contraindications	4
Warnings	4
Precautions	6
Potential Adverse Events	10
Warranty Information	12
PRE- IMPLANT INFORMATION	12
Surgical Preparation	12
Items Included	13
Additional Tools	13
Accessories	13
Vein Pick	13
Radiopaque Suture Sleeve	13
ACUITY X4 Flushing tool/Wire guide	14
Lead Cap	14
ACUITY X4 Connector Tool	14
IMPLANTATION	14
Overview of Lead Implant	15
Lead Implant	17
Electrical Performance	34
Tunneling the Lead	34
POSTIMPLANT	35
Postimplant Evaluation	35
Explantation	35
SPECIFICATIONS	36
Specifications (Nominal)	36
Lead Introducer	38
Symbols on Packaging	38

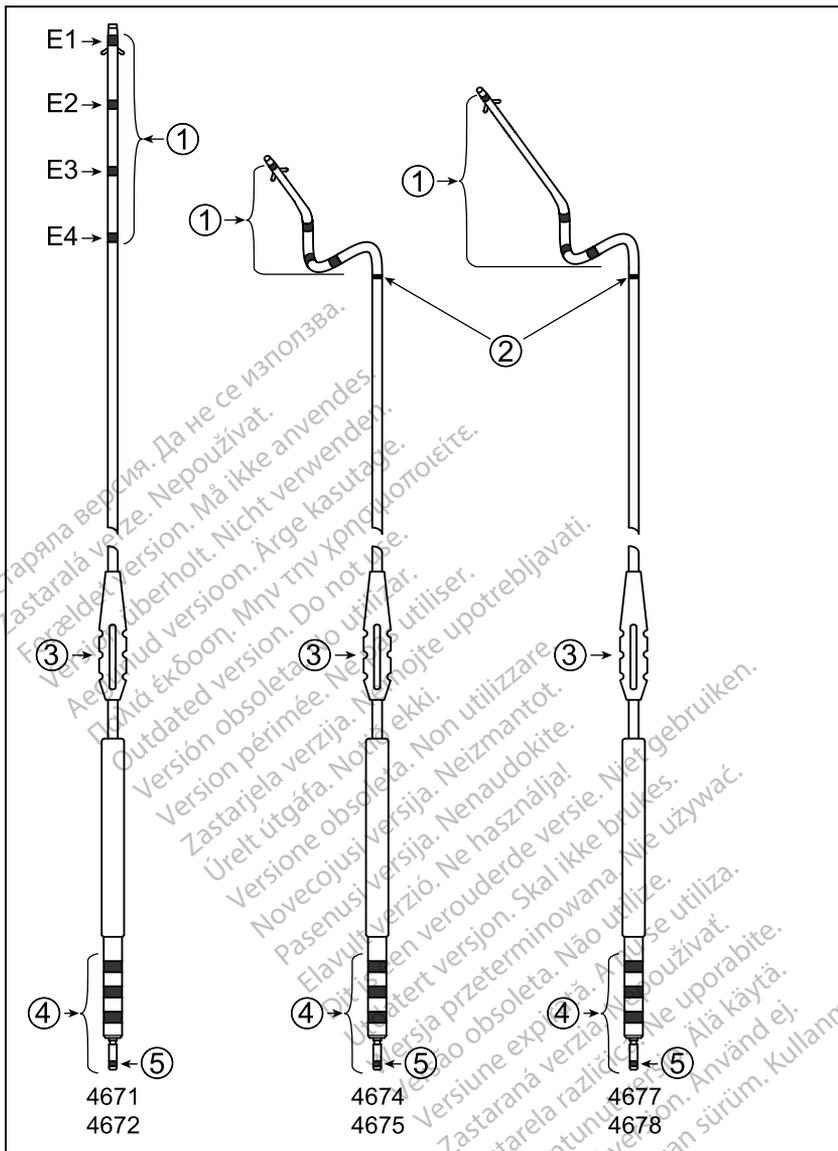

Tined (Straight models) and Tined + Spiral (Spiral models) fixation

1. Electrodes
2. Radiopaque marker band (Spiral models only)
3. Suture sleeve
4. IS4-LLLL four-pole connector
5. Terminal pin insertion indicator

INFORMATION FOR USE

Device Description

The Boston Scientific ACUITY X4 quadripolar coronary venous leads are intended for chronic left ventricular pacing and sensing. These steroid-eluting leads have an over-the-wire design and an IS4¹ four-pole connector. A variety of pace/sense configurations are possible with the four distal, IROX-coated electrodes that can function as cathodes (all four electrodes) or anodes (all except E1, the most distal electrode) when used with a compatible pulse generator.

This lead family has the following characteristics:

- Coronary venous pace/sense lead—intended for chronic left ventricular pacing and sensing. This transvenous lead offers various pace/sense configurations depending upon the programming options of a compatible device; refer to the pulse generator manual for instructions. Placement is achieved by inserting the lead through the coronary sinus and placing it into a branch of the cardiac vasculature.
- Three tip configuration designs (straight tip, short tip spiral, long tip spiral)—intended to provide choices for a variety of patient anatomies. A small diameter, atraumatic tip with small diameter silicone distal sections on all lead models is designed to track into tortuous vasculature.
- IS4 four-pole connector—the industry standard connector to be used in conjunction with a compatible cardiac device with an IS4-LLLL port, where L indicates a connection to a low-voltage pace/sense electrode.
- MR Conditional—leads can be used as part of the ImageReady MR Conditional Pacing System or the ImageReady MR Conditional Defibrillation System when connected to Boston Scientific MR Conditional pulse generators ("MR Conditional System Information" on page 3).
- IROX-coated electrodes—provide a pacing and sensing surface in the coronary venous system. The electrodes are coated with IROX (iridium oxide) to increase the microscopic surface area.
- 3D electrode spiral—the spiral model leads were designed to overcome challenges in mid-base (proximal) ventricular regions by clustering electrodes on the 3D spiral fixation, which is set back from the distal tip of the lead. The electrodes are spatially oriented on the spiral to increase the chance that at least one of the three electrodes will be placed adjacent to the myocardium in any coronary vasculature location.
- Lead body—the distal electrode (E1) is connected to the terminal pin by means of a coil conductor, while the three proximal electrodes (E2, E3, E4) are connected to the three terminal rings by means of three individual low voltage cable conductors. The coil conductor filars and the cables are sheathed in Ethylene tetrafluoroethylene (ETFE) insulation. The conductor separation insulation and the outer lead body insulation material are

1. IS4 refers to the international standard ISO 27186:2010.

polyurethane in the proximal region and silicone in the distal region adjacent to the electrodes and spiral fixation.

- Protected IS4 terminal pin design—all proximal electrical connections occur within the terminal pin that fits safely inside the device header. There are no splice points in the lead body outside of the header. With this protected IS4 design, the absence of splice points in the lead body offers the following advantages:
 - protection from flex fatigue and fracture
 - protection from pulse generator-on-lead and lead-on-lead abrasion
 - protection from acute bending at splice points due to lead wrap
 - fewer connection points
- Distal tip—the distal tip is protected by silicone rubber to allow lead advancement through the coronary venous system.
- Steroid-eluting—upon exposure to body fluids, the steroid elutes from the drug collar near the distal end of the lead to help reduce tissue inflammation response. The steroid suppresses the inflammatory response believed to cause threshold rises typically associated with implanted pacing electrodes. The nominal dose and structure of the steroid are listed in the specifications (Table 9 Specifications (Nominal) on page 37).
- Radiopaque suture sleeve—the radiopaque suture sleeve is visible under fluoroscopy and is used to secure, immobilize, and protect the lead at the venous entry site after lead placement. The window feature is designed to aid compression of the sleeve onto the lead during suturing.
- Tined fixation—silicone rubber tines located proximal to the distal electrode provide the option of passive fixation to the vasculature for all lead models.
- Spiral fixation—a distal, 3D spiral shape provides an additional or alternative passive fixation option for the spiral tip models.
- Fluoroscopic visibility—the platinum-iridium electrode design increases the visibility of the lead tip under fluoroscopy.
- Fluoroscopic marker—a radiopaque marker on the spiral models can be seen under fluoroscopy to indicate the approximate proximal end of the spiral fixation.
- Lubricious coating—the lead has a proprietary coating on the silicone distal region that makes the surface more lubricious. This reduces both the static and dynamic coefficients of friction, and makes the lead feel and handle like polyurethane while providing the flexibility of silicone.
- Over-the-Wire delivery method—the design consists of an open-lumen conductor coil that tracks over a guide wire.

Related Information

Instructions in the lead manual should be used in conjunction with other resource material, including the applicable pulse generator physician's manual and instructions for use on any implant accessories or tools.

For additional reference information, go to www.bostonscientific-elabeling.com.

Refer to the ImageReady MR Conditional Pacing System MRI Technical Guide or the ImageReady MR Conditional Defibrillation System MRI Technical Guide² (hereafter each referred to as the MRI Technical Guide) for information about MRI scanning.

INTENDED AUDIENCE

This literature is intended for use by professionals trained or experienced in device implant and/or follow-up procedures.

MR Conditional System Information

These leads can be used as part of the ImageReady MR Conditional Pacing System or the ImageReady MR Conditional Defibrillation System (hereafter each referred to as an MR Conditional System) when connected to Boston Scientific MR Conditional pulse generators. Patients with an MR Conditional System may be eligible to undergo MRI scans if performed when all Conditions of Use, as defined in the applicable MRI Technical Guide, are met.

Components required for MR Conditional status include specific models of Boston Scientific pulse generators, leads, and accessories; the Programmer and Programmer Software Application. For the model numbers of MR Conditional pulse generators and components, as well as a complete description of the ImageReady MR Conditional System, refer to the applicable MRI Technical Guide.

Implant-related MRI Conditions of Use

The following subset of the MRI Conditions of Use pertains to implantation, and is included as a guide to ensure implantation of a complete ImageReady MR Conditional System. For a full list of Conditions of Use, refer to the MRI Technical Guide. All items on the full list of Conditions of Use must be met in order for an MRI scan to be considered MR Conditional.

- Patient is implanted with the ImageReady MR Conditional Pacing System³ or the ImageReady MR Conditional Defibrillation System³
- No other active or abandoned implanted devices, components, or accessories present such as lead adaptors, extenders, leads, or pulse generators
- Pulse generator implant location restricted to left or right pectoral region
- At least six (6) weeks have elapsed since implantation and/or any lead revision or surgical modification of the MR Conditional System

2. Available at www.bostonscientific-elabeling.com.

3. Defined as a Boston Scientific MR Conditional pulse generator and lead(s), with all ports occupied by a lead or port plug.

- No evidence of a fractured lead or compromised pulse generator-lead system integrity

Indications and Usage

This Boston Scientific lead is indicated for use as follows:

- Intended for chronic, left-ventricular pacing and sensing via the coronary venous system when used in conjunction with a compatible pulse generator

Contraindications

Use of this Boston Scientific lead is contraindicated for the following patients:

- Patients with a hypersensitivity to a maximum single dose of 0.54 mg dexamethasone acetate

WARNINGS

General

- **Labeling knowledge.** Read this manual thoroughly before implantation to avoid damage to the pulse generator and/or lead. Such damage can result in patient injury or death.
- **For single patient use only.** Do not reuse, reprocess, or resterilize. Reuse, reprocessing, or resterilization may compromise the structural integrity of the device and/or lead to device failure which, in turn, may result in patient injury, illness, or death. Reuse, reprocessing, or resterilization may also create a risk of contamination of the device and/or cause patient infection or cross-infection, including, but not limited to, the transmission of infectious disease(s) from one patient to another. Contamination of the device may lead to injury, illness, or death of the patient.
- **Backup defibrillation protection.** Always have external defibrillation equipment available during implant and electrophysiologic testing. If not terminated in a timely fashion, an induced ventricular tachyarrhythmia can result in the patient's death.
- **Resuscitation availability.** Ensure that an external defibrillator and medical personnel skilled in CPR are present during post-implant device testing should the patient require external rescue.
- **Use of right ventricular lead.** When using a right ventricular (RV) pace/sense lead in conjunction with this left coronary venous pace/sense lead, it is recommended that a polyurethane-insulated RV lead be used. Failure to observe this warning could result in insulation damage of the RV lead, which can cause periodic or continual loss of pacing, or sensing, or both.
- **Lead fracture.** Lead fracture, dislodgment, abrasion, or an incomplete connection can cause a periodic or continual loss of pacing or sensing or both.

Handling

- **Excessive flexing.** Although pliable, the lead is not designed to tolerate excessive flexing, bending, or tension. This could cause structural weakness, conductor discontinuity, and/or lead dislodgment.
- **Do not kink leads.** Do not kink, twist, or braid the lead with other leads as doing so could cause lead insulation abrasion damage or conductor damage.
- **Handling the lead without Connector Tool.** Use caution handling the lead terminal when the Connector Tool is not present on the lead. Do not directly contact the lead terminal with any surgical instruments or electrical connections such as PSA (alligator) clips, ECG connections, forceps, hemostats, and clamps. This could damage the lead terminal, possibly compromising the sealing integrity and result in loss of therapy or inappropriate therapy.
- **Handling the terminal while tunneling.** Do not contact any other portion of the lead terminal, other than the terminal pin, even when the lead cap is in place.
- **Appropriate lead connections.** When implanting a system which uses both a DF4-LLHH/LLHO⁴ and IS4-LLLL⁵ lead, ensure that the leads are inserted and secured in the appropriate ports. Inserting a lead into an incorrect port will result in unanticipated device behavior (potentially leaving the patient without effective therapy).

Implant Related

- **Do not implant in MRI site Zone III.** Implant of the system cannot be performed in an MRI site Zone III (and higher) as defined by the American College of Radiology Guidance Document for Safe MR Practices⁶. Some of the accessories packaged with pulse generators and leads, including the torque wrench and stylet wires, are not MR Conditional and should not be brought into the MRI scanner room, the control room, or the MRI site Zone III or IV areas.
- **Only use Connector Tool for electrical connections.** Only use the Connector Tool for electrical connections to pacing system analyzers or similar monitors. Do not attach alligator clips directly to the lead terminal or damage could occur.
- **Obtain appropriate electrode position.** Take care to obtain appropriate electrode position. Failure to do so may result in suboptimal lead measurements.
- **Proper connections.** When connecting the lead to the pulse generator, it is very important that proper connections are made. An improper connection could result in loss of therapy or inappropriate therapy.

4. DF4 refers to the international standard ISO 27186:2010.

5. IS4 refers to the international standard ISO 27186:2010.

6. Kanal E, et al., American Journal of Roentgenology 188:1447-74, 2007.

Post-Implant

- **Magnetic Resonance Imaging (MRI) exposure.** Unless all of the MRI Conditions of Use (as described in the MRI Technical Guide) are met, MRI scanning of the patient does not meet MR Conditional requirements for the implanted system, and significant harm to or death of the patient and/or damage to the implanted system may result.

Refer to the MRI Technical Guide for potential adverse events applicable when Conditions of Use are met or not met, as well as for a complete list of MRI-related Warnings and Precautions.

- **Diathermy.** Do not subject a patient with an implanted pulse generator and/or lead to diathermy since diathermy may cause fibrillation, burning of the myocardium, and irreversible damage to the pulse generator because of induced currents.

PRECAUTIONS

Clinical Considerations

- **Dexamethasone acetate.** It has not been determined whether the warnings, precautions, or complications usually associated with injectable dexamethasone acetate apply to the use of a low concentration, highly localized, controlled-release device. Refer to the Physicians' Desk Reference™⁷ for a listing of potentially adverse effects.

Sterilization and Storage

- **If package is damaged.** The blister trays and contents are sterilized with ethylene oxide gas before final packaging. When the pulse generator and/or lead is received, it is sterile provided the container is intact. If the packaging is wet, punctured, opened, or otherwise damaged, return the pulse generator and/or lead to Boston Scientific.
- **Storage temperature.** Store at 25°C (77°F). Excursions are permitted between 15°C to 30°C (59°F to 86°F). Transportation spikes are permitted up to 50°C (122°F).
- **Use by date.** Implant the pulse generator and/or lead before or on the USE BY date on the package label because this date reflects a validated shelf life. For example, if the date is January 1, do not implant on or after January 2.

Handling

- **Do not immerse in fluid.** Do not wipe or immerse the tip electrode in fluid. Such treatment will reduce the amount of steroid available when the lead is implanted.
- **Chronic repositioning.** Optimum threshold performance might not be achieved if the lead is chronically repositioned because the steroid can be depleted.

7. Physicians' Desk Reference is a trademark of Thomson Healthcare Inc.

- **Protect from surface contamination.** The lead uses silicone rubber which can attract particulate matter, and therefore, must always be protected from surface contamination.
- **No mineral oil on lead electrodes.** Mineral oil should never come in contact with the lead electrodes. Mineral oil on the electrodes may inhibit conduction.
- **Ensure suture sleeve position.** Ensure the suture sleeve remains proximal to the venous entry site and near the terminal boot molding throughout the procedure until it is time to secure the lead.

Implantation

- **Evaluate patient for surgery.** There may be additional factors regarding the patient's overall health and medical condition that, while not related to device function or purpose, could render the patient a poor candidate for implantation of this system. Cardiac health advocacy groups may have published guidelines that may be helpful in conducting this evaluation.
- **Lead compatibility.** Prior to implantation, confirm the lead-to-pulse generator compatibility. Using incompatible leads and pulse generators can damage the connector and/or result in potential adverse consequences, such as undersensing of cardiac activity or failure to deliver necessary therapy.
- **Line-powered equipment.** Exercise extreme caution if testing leads using line-powered equipment because leakage current exceeding 10 μA can induce ventricular fibrillation. Ensure that any line-powered equipment is within specifications.
- **Do not bend the lead near the lead-header interface.** Insert the lead terminal straight into the lead port. Do not bend the lead near the lead-header interface. Improper insertion can cause insulation or connector damage.
- **Vein pick.** The vein pick is not intended either for puncturing the vein or for dissecting tissue during a cutdown procedure. Be sure that the vein pick does not puncture the insulation of the lead. This could prevent proper lead function.
- **Venogram risks.** Risks associated with coronary venography are similar to any other catheterization procedure in the coronary sinus. Some patients can have poor renal function or a physical intolerance to different types of contrast agents. If this is known in advance, select an appropriate agent. The type, amount, and rate of injection of the contrast medium must be determined by physician medical judgment regarding the adequacy of the venogram obtained.
- **Clotted lead.** Flushing a clotted lead can compromise lead integrity. If clotting is suspected, remove the lead from the body and soak the lead in heparinized saline. Insert a guide wire into either the terminal or distal tip of the lead and advance the wire to clear clotting. If unsuccessful, use a new lead.

- **Tools applied to distal end.** Do not apply tools to the distal end of the lead because lead damage could occur. Avoid holding or handling the distal tip of the lead.
- **Do not implant lead under clavicle.** When attempting to implant the lead via a subclavian puncture, do not introduce the lead under the medial one-third region of the clavicle. Damage or chronic dislodgment to the lead is possible if the lead is implanted in this manner. If implantation via the subclavian vein is desired, the lead must enter the subclavian vein near the lateral border of the first rib to avoid entrapment by the subclavius muscle or ligamentous structures associated with the narrow costoclavicular region. It has been established in the literature that lead fracture can be caused by lead entrapment in such soft tissue structures as the subclavius muscle, costocoracoid ligament, or the costoclavicular ligament.⁸
- **Compatible delivery tools.** Only use compatible delivery tools to deliver the lead because using incompatible delivery tools may cause lead damage or patient injury.
- **Inserting guide wire.** Use care when inserting the proximal end of a guide wire into the distal tip of the leads. If inserted too quickly and/or roughly, the stiff end of the guide wire may damage the lead lumen and affect the lead performance.
- **Do not kink the guide wire.** Do not kink the guide wire in the lead. Kinking the guide wire could lock it in the lead or damage the conductor coil.
- **Guide wire prolapse.** Use fluoroscopy to verify the guide wire does not prolapse and catch on the distal tip of the lead. If this occurs, slowly extend the wire beyond the distal tip or withdraw the lead slightly to free the guide wire, and then retract the guide wire to reestablish its movement.
- **Guide wire retraction.** If the guide wire cannot be retracted, withdraw the lead/guide wire assembly through the guide catheter. Remove the guide wire through the distal tip of the lead and reintroduce the lead using a new guide wire. Follow the positioning procedures in this manual.
- **Remove guide wire.** The guide wire must be removed before connecting the lead to the pulse generator. Do not complete implant with the guide wire inside the lead because it could cause lead perforation, or myocardial or coronary venous perforation. If the guide wire cannot be removed from the lead, withdraw the lead and guide wire together.
- **Strain relief.** When implanting the lead via a subclavian puncture, allow slack in the lead between the suture sleeve and the venous entry site. This will help minimize flexing at the suture sleeve and interaction with the clavicle/first rib region.

8. Magney JE, et al. Anatomical mechanisms explaining damage to pacemaker leads, defibrillator leads, and failure of central venous catheters adjacent to the sternoclavicular joint. PACE. 1993;16:445–457.

- **Avoid tight stricture.** When ligating the vein, avoid stricture that is too tight. A tight stricture might damage the insulation or sever the vein. Avoid dislodging the distal tip during the anchoring procedure.
- **Do not suture directly over lead.** Do not suture directly over the lead body, as this may cause structural damage. Use the suture sleeve to secure the lead proximal to the venous entry site to prevent lead movement.
- **Use caution to remove suture sleeve.** Avoid removing or cutting the suture sleeve from the lead. If removal of the suture sleeve is necessary, use caution as lead damage can occur.
- **Use of multiple suture sleeves has not been evaluated.** Use of multiple suture sleeves has not been evaluated and is not recommended.
- **Tunnel the lead.** Tunnel the lead from the chest area to the pulse generator implant site. Do not tunnel the lead from the pulse generator implant site to the chest area because this can damage the electrodes or lead body or both by permanently stretching the lead.
- **Excessive tension on lead.** When tunneling the lead, take precautions not to place excessive tension on the lead. This can cause either structural weakness and/or conductor discontinuity.
- **Re-evaluate the lead after tunneling.** After tunneling, re-evaluate the lead to verify that no significant change in signals or damage to the lead has occurred during the tunneling procedure. Reattach the Connector Tool and repeat the steps in Evaluating Lead Performance.

Hospital and Medical Environments

- **Electrocautery.** Electrocautery may induce ventricular arrhythmias and/or fibrillation, and may cause asynchronous pacing, inhibition of pacing, and/or a reduction in pulse generator pacing output possibly leading to loss of capture.

If electrocautery is medically necessary, observe the following to minimize risk to the lead. Also, refer to pulse generator labeling for device programming recommendations and additional information about minimizing risk to the patient and system.

- Avoid direct contact between the electrocautery equipment and the pulse generator or leads.
- Keep the path of the electrical current as far away as possible from the pulse generator and leads.
- If electrocautery is performed on tissue near the device or leads, monitor pre- and post- measurements for sensing and pacing thresholds and impedances to determine the integrity and stability of the system.
- Use short, intermittent, and irregular bursts at the lowest feasible energy levels.
- Use a bipolar electrocautery system where possible.

- **Radio frequency (RF) ablation.** RF ablation may induce ventricular arrhythmias and/or fibrillation, and may cause asynchronous pacing, inhibition of pacing, and/or a reduction in pulse generator pacing output possibly leading to loss of capture. RF ablation may also cause ventricular pacing up to the Maximum Tracking Rate (MTR) and/or changes in pacing thresholds. Additionally, exercise caution when performing any other type of cardiac ablation procedure in patients with implanted devices.

If RF ablation is medically necessary, observe the following to minimize risk to the lead. Also, refer to pulse generator labeling for device programming recommendations and additional information about minimizing risk to the patient and system.

- Avoid direct contact between the ablation catheter and the pulse generator and leads. RF ablation close to the lead electrode may damage the lead-tissue interface.
- Keep the path of the electrical current as far away as possible from the pulse generator and leads.
- If RF ablation is performed on tissue near the device or leads, monitor pre- and post-measurements for sensing and pacing thresholds and impedances to determine the integrity and stability of the system.

- **Central line guidewire insertion.** Use caution when inserting guidewires for placement of other types of central venous catheter systems such as PIC lines or Hickman catheters in locations where pulse generator leads may be encountered. Insertion of such guidewires into veins containing leads could result in the leads being damaged or dislodged.

Follow-up Testing

- **Lead performance in chronic state.** For some patients, lead performance at implant may not predict performance in the chronic state. Therefore, it is recommended that post-implant lead evaluation follow-up be done at the routine pulse generator follow-up and additionally as necessary.

Potential Adverse Events

Based on the literature and on pulse generator and/or lead implant experience, the following list includes the possible adverse events associated with implantation of products described in this literature:

- Acceleration of arrhythmias
- Adverse reaction to procedure (e.g., bradycardia, general, respiratory, hypotension)
- Air embolism
- Allergic reaction
- Arterial damage with subsequent stenosis
- Bleeding
- Bradycardia
- Breakage/failure of the implant instruments

- Cardiac perforation
- Cardiac tamponade
- Chronic nerve damage
- Component failure
- Conductor coil fracture
- Coronary venous spasm
- Death
- Electrolyte imbalance/dehydration
- Elevated thresholds
- Erosion
- Excessive fibrotic tissue growth
- Extracardiac stimulation (muscle/nerve stimulation)
- Fluid accumulation
- Foreign body rejection phenomena
- Formation of hematomas or seromas
- Heart block
- Hemorrhage
- Hemothorax
- Inability to pace
- Inappropriate therapy (e.g., shocks and antitachycardia pacing [ATP] where applicable, pacing)
- Incisional pain
- Incomplete lead connection with pulse generator
- Infection including endocarditis
- Lead dislodgment
- Lead fracture
- Lead insulation breakage or abrasion
- Lead tip deformation and/or breakage
- Malignancy or skin burn due to fluoroscopic radiation
- Myocardial trauma (e.g., irritability, injury, tissue damage)
- Myopotential sensing
- Oversensing/undersensing
- Pacemaker-mediated tachycardia (PMT)
- Pericardial rub, effusion
- Pneumothorax
- Pulse generator and/or lead migration

- Shunting current or insulating myocardium during defibrillation with internal or external paddles
- Syncope
- Tachyarrhythmias, which include acceleration of arrhythmias and early, recurrent atrial fibrillation
- Thrombosis/thromboemboli
- Valve damage
- Vasovagal response
- Venous occlusion
- Venous trauma (e.g., perforation, dissection, erosion)

For a list of potential adverse events associated with MRI scanning, refer to the appropriate ImageReady MR Conditional Pacing System or Defibrillation System MRI Technical Guide.

Additionally, potential adverse events associated with the implantation of a coronary venous lead system include:

- Allergic reaction to contrast media
- Prolonged exposure to fluoroscopic radiation
- Renal failure from contrast media used to visualize coronary veins

Warranty Information

A limited warranty certificate for the lead is available. For a copy, contact Boston Scientific using the information on the back cover.

PRE- IMPLANT INFORMATION

Proper surgical procedures and techniques are the responsibility of the medical professional. The described implant procedures are furnished only for informational purposes. Each physician must apply the information in these instructions according to professional medical training and experience.

The lead is designed, sold, and intended for use only as indicated.

Surgical Preparation

Consider the following prior to the implantation procedure:

- Instrumentation for cardiac monitoring, imaging (fluoroscopy), external defibrillation, and lead signal measurements must be available during implant.
- Always isolate the patient from potentially hazardous leakage current when using electrical instrumentation.
- Sterile duplicates of all implantable items should be available for use if accidental damage or contamination occurs.
- The sterile field should be large enough to accommodate the use of the guide wires.

Items Included

The following items are packaged with the lead:

- Vein pick
- ACUITY X4 Flushing tool/Wire guide
- ACUITY X4 Connector Tool
- Literature

Additional Tools

The following is a list of items used for implanting the lead, but not packaged with the lead:

- Guide catheter intended for accessing the coronary venous system
- Optional tools for advancing the guide catheter to the right atrium and cannulating the coronary sinus:
 - Guide wire intended for use in the coronary venous vasculature
 - Inner guide catheter intended for accessing the coronary venous system
 - Deflectable tip mapping catheter intended for use in the coronary sinus ostium
- Standard occlusion balloon used to obtain venograms by occluding the coronary sinus
- Guide wire compatible with the lead diameter and intended for use in the coronary venous system

Accessories

Separately packaged lead accessories are available in addition to those packaged with the lead.

Vein Pick

The vein pick is a disposable plastic device designed to assist with insertion into a vein during a cutdown procedure.

Radiopaque Suture Sleeve

The radiopaque suture sleeve is an adjustable, tubular reinforcement that is visible under fluoroscopy. It is positioned over the outer lead insulation and is designed to secure and protect the lead at the venous entry site after lead placement. Using a suture sleeve reduces the possibility of structural damage caused by suturing directly over the lead body. To move the suture sleeve, gently pinch and slide it over the lead until it is in the desired position. The window feature is designed to aid compression of the sleeve onto the lead during suturing.

NOTE: A radiopaque suture sleeve is pre-loaded on the lead and is also available in a slit form as an accessory (Model 4603). The accessory slit suture

sleeve is intended to be used as a replacement for the pre-loaded suture sleeve in the event of damage or loss.

CAUTION: Use of multiple suture sleeves has not been evaluated and is not recommended.

ACUITY X4 Flushing tool/Wire guide

The flushing tool with integrated wire guide is compatible with both luer lock and luer slip tip syringes used for flushing the lead. The integrated wire guide is intended to ease insertion of a guide wire into the lumen at the terminal of the lead.



Figure 1. ACUITY X4 Flushing tool/Wire guide

Lead Cap

The lead cap may be used to isolate or cap the lead terminal that is not inserted in the pulse generator. Place a suture around the lead cap groove to secure the lead cap to the lead terminal. Use an appropriate cap for lead.

ACUITY X4 Connector Tool

The Connector Tool performs the following functions when attached to the lead:

- Protects the lead terminal during the implant procedure when determining lead electrical performance
- Provides a safe and secure connection between PSA patient cables and the lead terminal

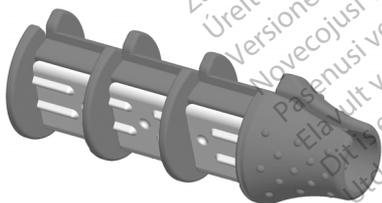

Figure 2. ACUITY X4 Connector Tool

IMPLANTATION

NOTE: Refer to the appropriate ImageReady MR Conditional Pacing System or Defibrillation System MRI Technical Guide for considerations affecting choice and implant of leads for use as part of an MR Conditional system. Use of Boston Scientific MR Conditional pulse generators and leads is required for an implanted system to be considered MR Conditional. Refer to the appropriate ImageReady MR Conditional Pacing System or Defibrillation System MRI

Technical Guide for model numbers of pulse generators, leads, accessories, and other system components needed to satisfy the Conditions of Use for MR Conditional scanning.

NOTE: *Other implanted devices or patient conditions may cause a patient to be ineligible for an MRI scan, independent of the status of the patient's ImageReady MR Conditional System.*

Overview of Lead Implant

Implanting the coronary venous lead includes the following steps:

1. Insert a guide catheter into the ostium of the coronary sinus to provide a path for lead placement.
2. Obtain a venogram to visualize the coronary venous system.
3. Identify a target vein and select the appropriate type of lead for the patient's anatomy.
4. Prepare the lead and guide wire.
5. Position the lead deep into the anatomy.
6. Evaluate lead performance.
7. Remove the guide catheter and guide wire.
8. Secure the lead.
9. Connect to a pulse generator.

The lead is introduced into the coronary venous system through the ostium of the coronary sinus and advanced into its tributaries. See the following graphics for the anterior posterior (AP) view and the lateral anterior oblique (LAO) view of the coronary venous system. The coronary tributaries include the middle cardiac vein, left posterior vein, left marginal (or lateral) vein, and anterior vein. All cardiac veins are potential sites for implantation of this lead. Variability in patient anatomy may preclude placement in one or more of the suggested sites.

Anterior Posterior (AP) view of the coronary venous system

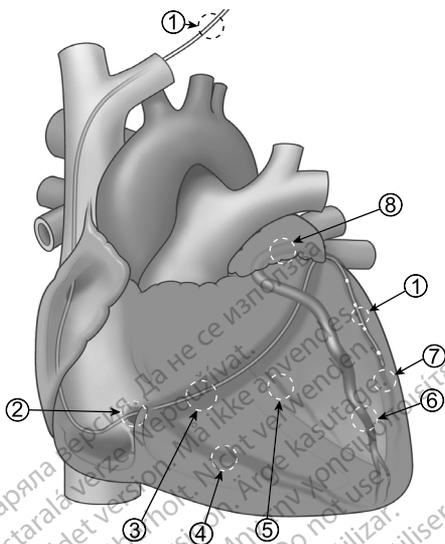

Legend:

1. Lead
2. Ostium of coronary sinus
3. Coronary sinus
4. Middle cardiac vein
5. Left posterior vein
6. Anterior vein
7. Left marginal vein
8. Great cardiac vein

Lateral Anterior Oblique (LAO) view of the coronary venous system

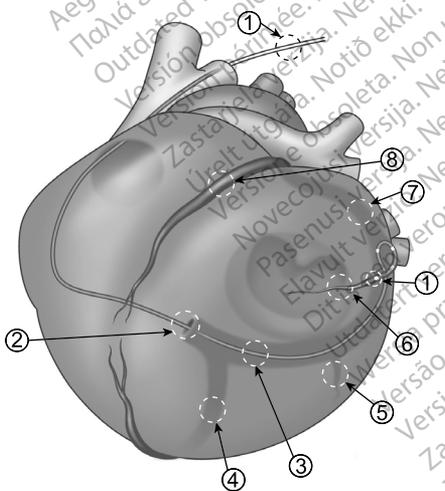

Legend:

1. Lead
2. Ostium of coronary sinus
3. Coronary sinus
4. Middle cardiac vein
5. Left posterior vein
6. Left marginal vein
7. Great cardiac vein
8. Anterior vein

NOTE: It is recommended that a venogram be performed to determine the patient's coronary venous anatomy. This is important in order to identify potential implant sites and to select the appropriate lead model for the intended implant site. Any preexisting condition of the patient, e.g., coronary stent or

coronary artery bypass graft (CABG), should be taken into consideration while using proper medical judgment to determine the best lead implant site.

Lead Implant

1. **Inserting the guide catheter and cannulating the coronary sinus.** The lead is inserted via a coronary guide catheter, not introduced directly into the vasculature. A guide catheter with a minimum inner diameter of 0.081 inch (2.06 mm) is first inserted at a venous access point. The guide catheter serves as a conduit for the delivery of implantable coronary venous leads and can help protect the coronary venous lead during the placement of other leads. An introducer is recommended to provide support for venous access while inserting a guide catheter. Refer to the instructions accompanying the introducer. After insertion, the guide catheter is then advanced into the coronary sinus to provide a path for the lead into the coronary venous system.

One of the following venous access points can be used to insert the guide catheter:

- cephalic vein
- subclavian vein
- internal jugular vein

Use professional medical judgment to determine which of the following methods to use for guide catheter insertion at the venous access point:

- venous cutdown technique
- percutaneous implant technique

CAUTION: The vein pick is not intended either for puncturing the vein or for dissecting tissue during a cutdown procedure. Be sure that the vein pick does not puncture the insulation of the lead. This could prevent proper lead function.

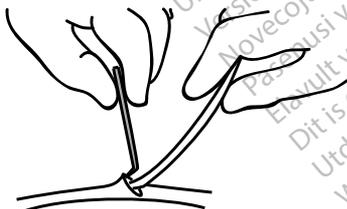

Figure 3. Using the vein pick

CAUTION: When attempting to implant the lead via a subclavian puncture, do not introduce the lead under the medial one-third region of the clavicle. Damage or chronic dislodgment to the lead is possible if the lead is implanted in this manner. If implantation via the subclavian vein is desired, the lead must enter the subclavian vein near the lateral border of the first rib to avoid entrapment by the subclavius muscle or ligamentous structures associated with the narrow costoclavicular region. It has been established in the literature that lead fracture can be caused by lead

entrapment in such soft tissue structures as the subclavius muscle, costocoracoid ligament, or the costoclavicular ligament.⁹

Methods for inserting the guide catheter into the coronary sinus include, but are not limited to, the following:

- Directly access the coronary sinus ostium with the curve of the guide catheter alone.
- Advance a guide wire (≈ 0.035 inch / 0.89 mm) through the guide catheter and extend it into the ostium of the coronary sinus and then follow with the guide catheter.
- Insert a fixed-shape catheter or a mapping catheter through the guide catheter and extend it into the ostium of the coronary sinus. Follow with the guide catheter.

NOTE: To minimize the possibility of dissection, a guide wire may be used when advancing the guide catheter through the venous system, right atrium, and the coronary sinus.

To confirm proper placement of the guide catheter tip in the coronary sinus, inject a small amount of contrast medium into the coronary sinus while under fluoroscopy. The contrast agent will flow out of the coronary sinus.

2. **Obtaining a venogram.** Once the guide catheter is properly placed in the coronary sinus, obtain a venogram to visualize the coronary venous system. The venogram should display the distal terminations of potential target veins in order to assess lead selection. Use professional medical judgment to determine whether an occlusion balloon catheter should be used to identify the distal cardiac veins. Refer to the instructions accompanying the balloon catheter. Save the acquired venogram for future reference of the venous anatomy.

NOTE: To minimize the possibility of dissection, a guide wire may be used when introducing the balloon catheter into the coronary venous system.

CAUTION: Risks associated with coronary venography are similar to any other catheterization procedure in the coronary sinus. Some patients can have poor renal function or a physical intolerance to different types of contrast agents. If this is known in advance, select an appropriate agent. The type, amount, and rate of injection of the contrast medium must be determined by physician medical judgment regarding the adequacy of the venogram obtained.

3. **Identifying a target vein and choosing the appropriate type of lead.** Use the venogram to identify a suitable target vein for lead implantation. Each physician must apply their professional medical training, experience, and judgment in the determination. Important

9. Magney JE, et al. Anatomical mechanisms explaining damage to pacemaker leads, defibrillator leads, and failure of central venous catheters adjacent to the sternoclavicular joint. PACE. 1993;16:445–457.

considerations in the selection of a target branch vein include the following:

- Patient history (e.g., location of a previous infarct, evidence of a delayed mechanical activation)
- Proper location on the ventricle (posterior, lateral, anterior)
- Vein accessibility, considering size, length, and tortuosity
- Probability of lead stability

Once a target branch vein for implantation is identified, choose an appropriate lead based on the estimated size and length of the target vein, and on the patient's anatomy and medical condition.

Lead Length Selection

Identify a lead with an appropriate length using the information in the following table (Table 1 Lead Tip Configuration, Length, and Model Number on page 19).

Table 1. Lead Tip Configuration, Length, and Model Number

Tip configuration	Length (cm)	Model number
Straight	86	4671
	95	4672
Spiral S	86	4674
	95	4675
Spiral L	86	4677
	95	4678

NOTE: Select the appropriate lead length for a given patient. It is important to select a lead that is long enough to avoid any sharp angles or kinks and to allow for a gentle curve of excess lead in the pocket.

NOTE: Use of a secondary inner catheter instead of a guide wire for sub-selecting a branch vein may require the selection of a longer lead.

Lead Model Selection

Straight and spiral tip configuration lead models are available to provide appropriate choices for a variety of vein lengths, i.e., long versus shorter veins. In general:

- A Spiral L model is recommended when an implantable lateral or posterior vein approaches or reaches the apical one-third region of the heart.
- A Spiral S model is recommended when an implantable vein reaches only the middle region of the heart.
- A Straight model is recommended when an implantable vein is short, narrow, or torturous.

Spiral Tip Configuration Models The entire spiral shape, including all four electrodes, must be positioned within the branch vein to ensure proper spiral fixation. A radiopaque marker on the spiral models indicates the approximate proximal end of the spiral fixation and must be positioned within the branch vein for correct lead placement.

Table 2. Minimum vein length required for Spiral models

Spiral models	Length from tip to radiopaque marker with lead straightened (cm)
Spiral S 4674, 4675	6.0
Spiral L 4677, 4678	7.5

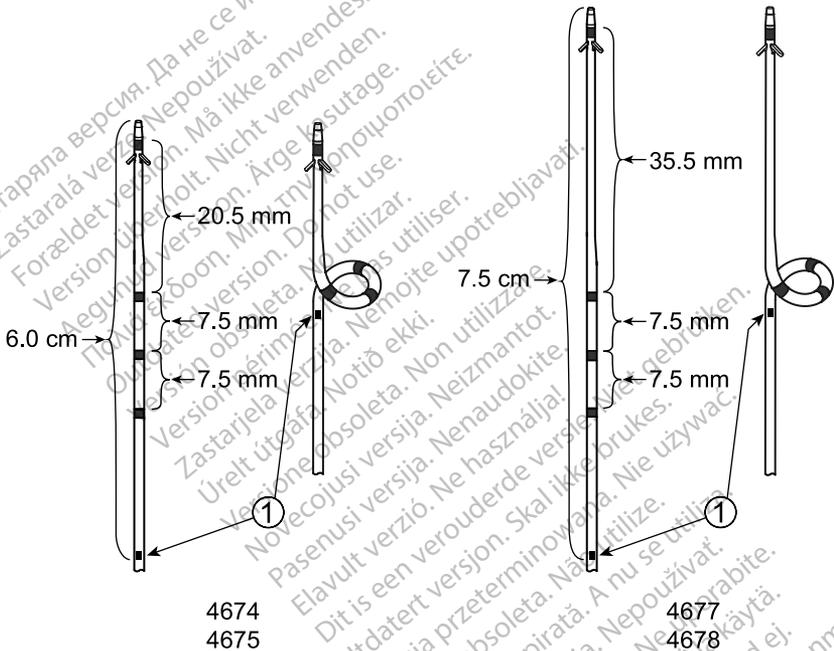

[1] Radiopaque marker on the Spiral S (4674, 4675) and Spiral L (4677, 4678) models.

Figure 4. Implantation length (tip to radiopaque marker) and distance between electrodes on Spiral models

Straight tip configuration models A straight tip configuration may be the most appropriate model for very short veins since the lead will be functional and fixed if the distal tip tines can be lodged within the branch vein. In order to position all four electrodes of a straight tip configuration model within the target branch vein, a vein length of > 4.0 cm is optimal.

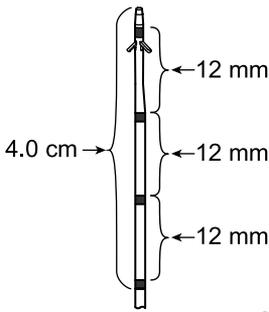

4671

4672

Figure 5. Implantation length (tip to most proximal electrode) and distance between electrodes on Straight models

4. **Preparing the lead and guide wire.** Prior to implant, flush the selected lead with heparinized saline using the flushing tool with integrated wire guide. Insert the terminal pin of the lead into the flushing tool, and then attach a suitable syringe for flushing (Figure 6 Syringe attached to Flushing tool/Wire guide with lead inserted). The flushing tool is compatible for use with luer lock or luer slip tip syringes. Note that a portion of the terminal pin will remain visible when fully inserted into the flushing tool.

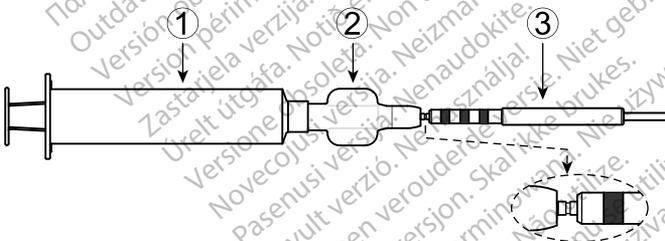

[1] Luer lock syringe, [2] Flushing tool/Wire guide, [3] Lead terminal

Figure 6. Syringe attached to Flushing tool/Wire guide with lead inserted

Use of a 0.014 inch (0.356 mm) maximum in diameter guide wire is recommended. Also flush the guide wire hoop with heparinized saline prior to use. Refer to the instructions accompanying the guide wire.

With the flushing tool still attached to the lead, preload the lead with the guide wire. A wire guide is integrated into the flushing tool to facilitate the insertion of the guide wire (Figure 7 Guide wire inserted through the Flushing tool/Wire guide into the lead on page 22). Extend the guide wire beyond the distal tip of the lead to ensure the guide wire slides easily through the lumen, and, for spiral models, to straighten the spiral fixation of the lead.

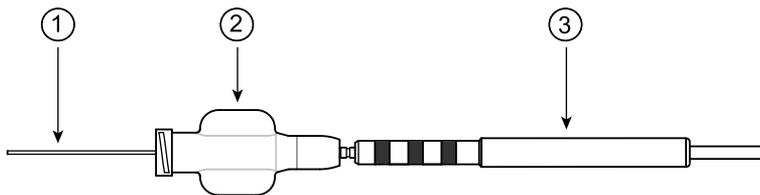

[1] Guide wire, [2] Flushing tool/Wire guide, [3] Lead terminal

Figure 7. Guide wire inserted through the Flushing tool/Wire guide into the lead

NOTE: Consider the venous anatomy of the patient and the lead choice when selecting the appropriate guide wire for lead delivery. Guide wires with varying distal stiffness will straighten the spiral fixation of the spiral models to varying degrees. Guide wires with more distal support will provide the greatest amount of spiral straightening.

CAUTION: Use care when inserting the proximal end of a guide wire into the distal tip of the leads. If inserted too quickly and/or roughly, the stiff end of the guide wire may damage the lead lumen and affect the lead performance.

5. Positioning the lead deep in the anatomy. The lead can be delivered either through the outer guide catheter used to cannulate the coronary sinus or through an inner catheter that has been introduced through the cannulation guide catheter for the purpose of subselecting a branch vein. Refer to the venogram previously obtained during positioning of the lead.

NOTE: The delivery catheter must have an inner diameter compatible with (larger than) the lead diameter and must be removable over the lead.

NOTE: To prevent blood from clotting in the lead and in the catheter, it is recommended to flush the inner lumen of the lead and of the catheter with heparinized saline before and during use.

CAUTION: Only use compatible delivery tools to deliver the lead because using incompatible delivery tools may cause lead damage or patient injury.

The following section describes two preferred methods for lead placement over a guide wire after the guide catheter has been positioned in the coronary sinus and a venogram has been obtained.

Method A

- a. Insert the floppy tip of the guide wire into the guide catheter and advance the tip of the wire through the coronary sinus to the desired position within the venous system.
- b. Insert the proximal end of the guide wire into the distal opening of the lead. While inserting the guide wire, straighten the spiral fixation of the spiral models carefully to prevent perforating the lead or damaging the conductor coil.

- c. While holding the guide wire in place, advance the lead over the wire to the desired lead position.

Method B

- a. Insert the lead/guide wire assembly into the guide catheter. A transvalvular insertion/trans valve introducer (TVI) tool may be used to assist insertion of the lead/wire into the guide catheter. Refer to the instructions accompanying the TVI tool.
- b. Under fluoroscopy, advance the lead along the guide wire into the coronary venous. Advance the guide wire through the coronary sinus to the desired position within the venous system.
- c. While holding the guide wire in place, advance the lead over the wire to the desired lead position.

When the lead is in the desired target branch vein, advance the lead to a distal location within that branch until the tip of the lead is in the desired location. The tined fixation may be wedged. Under fluoroscopy confirm that the electrodes remain within the branch vein, and, in addition for the spiral tip configuration models, that the radiopaque marker band proximal to the spiral fixation remains within the branch vein.

Partially withdraw the guide wire at least 8 cm prior to analyzing electrical performance. For spiral tip configuration models, the partial withdrawal of the guide wire will allow the spiral fixation to expand and engage. During withdrawal of the guide wire, apply a gentle forward push on the lead body to further lodge the lead tip in the vein and engage the fixation.

CAUTION: Use fluoroscopy to verify the guide wire does not prolapse and catch on the distal tip of the lead. If this occurs, slowly extend the wire beyond the distal tip or withdraw the lead slightly to free the guide wire, and then retract the guide wire to reestablish its movement.

CAUTION: If the guide wire cannot be retracted, withdraw the lead/guide wire assembly through the guide catheter. Remove the guide wire through the distal tip of the lead and reintroduce the lead using a new guide wire. Follow the positioning procedures in this manual.

CAUTION: Flushing a clotted lead can compromise lead integrity. If clotting is suspected, remove the lead from the body and soak the lead in heparinized saline. Insert a guide wire into either the terminal or distal tip of the lead and advance the wire to clear clotting. If unsuccessful, use a new lead.

CAUTION: Do not apply tools to the distal end of the lead because lead damage could occur. Avoid holding or handling the distal tip of the lead.

6. Evaluating lead performance.

Attaching the Connector Tool to the Lead

Slide the ACUITY X4 Connector Tool onto the proximal end of the lead so that the terminal pin extends beyond the end of the tool and the lead is fully inserted (Figure 8 ACUITY X4 Connector Tool alone and with a lead/

guide wire fully inserted on page 24). The Connector Tool is able to be attached to a lead with or without a guide wire inserted.

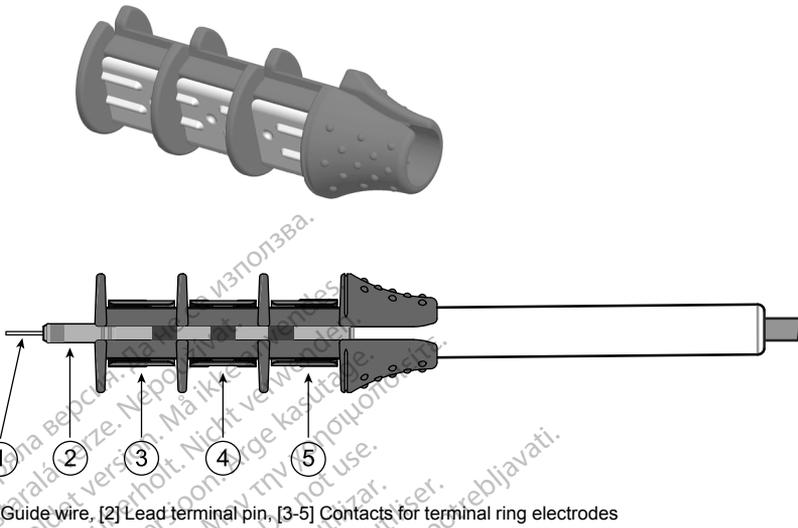
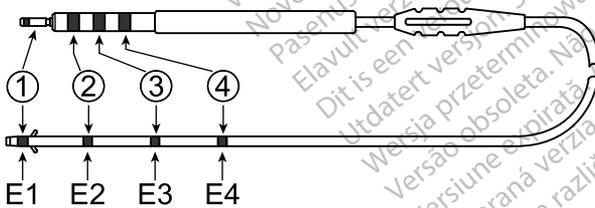

Figure 8. ACUITY X4 Connector Tool alone and with a lead/guide wire fully inserted

The corresponding relationship between the lead distal tip electrodes and the terminal pin and ring contacts is illustrated in the following figure (Figure 9 Relationship between the terminal pin and ring contacts with the distal tip electrodes E1 - E4 on page 24). All straight tip and spiral tip configuration lead models consist of the same relationship between the terminal pin and rings with the distal electrodes.



[1] Terminal pin connected to E1, [2] Terminal ring connected to E2, [3] Terminal ring connected to E3, [4] Terminal ring connected to E4

Figure 9. Relationship between the terminal pin and ring contacts with the distal tip electrodes E1 - E4

Electrical Measurements

Verify electrical performance of the lead using a pacing system analyzer (PSA) or similar device before attaching the lead to the pulse generator. Threshold measurements can be taken immediately after the lead is positioned and the fixation is engaged.

NOTE: For spiral tip configuration models of leads, the guide wire must be partially withdrawn so the spiral fixation is engaged when performing lead evaluation.

The 17 programmable pacing configurations possible with a compatible Boston Scientific pulse generator are shown in the following table.

Table 3. Programmable pacing configurations with a Boston Scientific pulse generator

	Cathode				
		E1	E2	E3	E4
Anode	E2	Bi		Bi	Bi
	E3	Bi	Bi		Bi
	E4	Bi	Bi	Bi	
	RV Coil	ExtBi	ExtBi	ExtBi	ExtBi
	Pulse Generator	Uni	Uni	Uni	Uni

In the table above, Bi indicates bipolar configurations, ExtBi indicates extended bipolar configurations, and Uni indicates unipolar configurations. See the following graphics for details and examples of the different types of programmable pacing configurations.

Table 4. Bipolar Configurations

Bipolar configurations are available by using combinations of the LV lead electrodes as a cathode and as an anode.	
<p>All Possible Bipolar Configurations</p> <p><u>Distal Zone</u> E1 (-) → E2 (+) E1 (-) → E3 (+) E1 (-) → E4 (+)</p> <p><u>Proximal Zone</u> E2 (-) → E3 (+) E2 (-) → E4 (+) E3 (-) → E2 (+) E3 (-) → E4 (+) E4 (-) → E2 (+) E4 (-) → E3 (+)</p>	<p>Example of E1 (-) → E3 (+) Bipolar Configuration</p>  <p>Legend: 1. E1 2. E2 3. E3 4. E4 5. Pulse Generator (PG) 6. RV Coil</p>

Table 5. Extended Bipolar Configurations

Extended bipolar configurations are available by using any LV lead electrode as a cathode and an RV lead electrode as an anode.	
<p>All Possible Extended Bipolar Configurations</p> <p>E1 (-) → RV Coil (+) E2 (-) → RV Coil (+) E3 (-) → RV Coil (+) E4 (-) → RV Coil (+)</p>	<p>Example of E3 (-) → RV Coil (+) Extended Bipolar Configuration</p>  <p>Legend:</p> <ol style="list-style-type: none"> 1. E1 2. E2 3. E3 4. E4 5. Pulse Generator (PG) 6. RV Coil

Table 6. Unipolar Configurations

Unipolar configurations are available by using any LV lead electrode as a cathode and the pulse generator as an anode.	
<p>All Possible Unipolar Configurations</p> <p>E1 (-) → PG (+) E2 (-) → PG (+) E3 (-) → PG (+) E4 (-) → PG (+)</p>	<p>Example of E2 (-) → PG (+) Unipolar Configuration</p>  <p>Legend:</p> <ol style="list-style-type: none"> 1. E1 2. E2 3. E3 4. E4 5. Pulse Generator (PG) 6. RV Coil

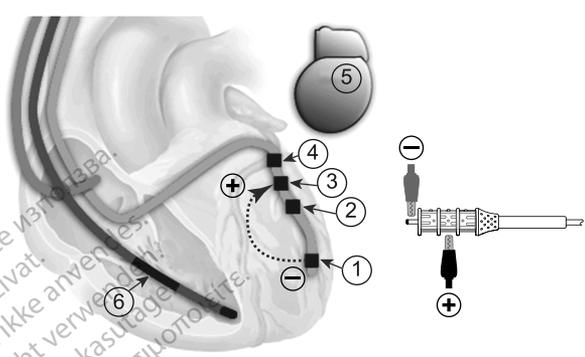
Attach the PSA cable alligator clips to the anode (+) and cathode (-) contacts as determined for each configuration tested. Use of the Connector Tool will protect the terminal pin from alligator clip damage and prevent bridging between terminal contacts. Fully engage the alligator clips on the cathode and anode contacts to avoid inaccurate baseline measurements.

WARNING: Only use the Connector Tool for electrical connections to pacing system analyzers or similar monitors. Do not attach alligator clips directly to the lead terminal or damage could occur.

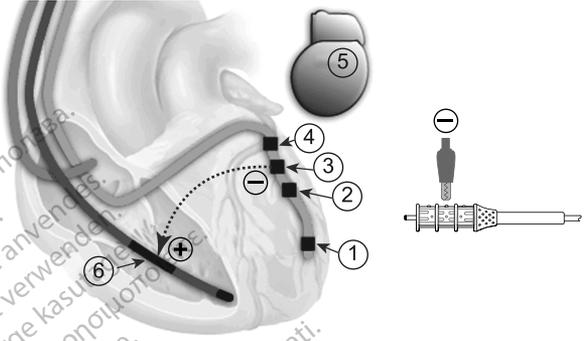
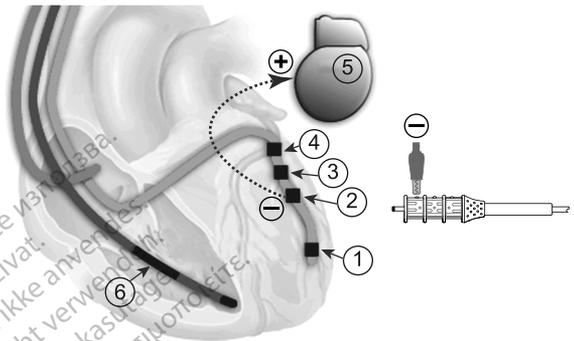
Use professional medical judgment to determine the configurations to test, considering the capabilities of the compatible pulse generator. It is recommended to perform a minimum of 6 threshold measurements. First test 4 extended bipolar (or 4 unipolar) configurations to determine adequate electrode-myocardium contacts (Table 3 Programmable pacing configurations with a Boston Scientific pulse generator on page 25). Test for the presence of extracardiac or phrenic nerve stimulation for each electrode. If stimulation is detected, measure a phrenic nerve stimulation (PNS) threshold.

The four extended bipolar, or unipolar, measurements provide a relative threshold ranking among the electrodes which is associated to the proximity of each electrode to viable myocardium. Although thresholds

may change, the relative ranking will be the same for bipolar measurements.

Then select 2 bipolar measurements (one distal zone bipolar and one proximal zone bipolar) to confirm the preferred distal and proximal pacing options (Table 4 Bipolar Configurations on page 26). Use the best extended bipolar (or unipolar) ring electrode as a cathode to any other ring electrode as an anode. Again, test for the presence of extracardiac or phrenic nerve stimulation for each electrode. If stimulation is detected, measure a PNS threshold.

NOTE: *The four extended bipolar measurements can be performed using some other indifferent electrode if an RV coil is not available.*

The recommended sensing R wave and pacing impedance for an acceptable vector are shown in the following table. The recommended pacing impedance range indicated in the table applies to all configurations (Table 7 Recommended Sensing and Impedance Measurements on page 29).

Table 7. Recommended Sensing and Impedance Measurements

Ventricular Data	
R-wave amplitude	≥ 3 mV
Pacing impedance	200–3000 Ω

Consider the following when performing electrical measurements:

- Pulse generator measurements may not exactly correlate to the PSA measurements due to signal filtering. Baseline measurements should fall within the recommended values indicated in the table.
- Lower R-wave amplitude, longer R-wave durations, and higher pacing threshold may indicate lead placement in ischemic or scarred tissue. Because signal quality may deteriorate, reposition the lead if necessary to obtain an intrinsic signal with the largest possible sensed amplitude and shortest duration, and the lowest pacing threshold.
- If you do not receive satisfactory measurements free of extracardiac or phrenic nerve stimulation in any available configuration, reposition the lead.
 - Remove the PSA alligator clips from the Connector Tool.
 - Reposition the lead to a more proximal location within the branch vein. Repeat the lead evaluation process.

NOTE: *Under fluoroscopy confirm that the electrodes remain within the branch vein, and, in addition for the spiral tip configuration models, that the radiopaque marker band proximal to the spiral fixation remains within the branch vein.*

- If testing results remain unsatisfactory after repositioning within the branch vein, it may be necessary to reposition the lead to a new branch vein and repeat the lead evaluation process.

- Test for extracardiac or phrenic nerve stimulation by pacing the lead at a high voltage output, using professional medical judgment to select the output voltage. Adjust the lead configurations and lead position as necessary. PSA testing at higher outputs may also be considered to better characterize stimulation margins. Testing should be conducted for all potential final lead placements.

Once acceptable measurements are obtained, remove the pacing system analyzer connections, and slide the Connector Tool off of the proximal end of the lead. If additional repositioning and/or PSA measurements are necessary, reattach the Connector Tool, ensuring the lead is fully inserted, and repeat the evaluation process.

Checking for Lead Stability

Follow these steps to check lead stability:

- Keep the guide wire partially withdrawn at least 8 cm into the lead after lead placement. During withdrawal of the guide wire, apply a gentle forward push on the lead body to further lodge the lead tip in the vein and engage the fixation.
- Check the stability of the lead using fluoroscopy.
- After the lead tip is positioned in the vasculature, slightly withdraw the guide catheter to observe the lead distal tip is fixated well.
- If the lead is wedged in the coronary vein, gently tug the lead to observe the guide catheter move slightly forward and towards the distal end of the lead, and the lead tip does not move (tug test).

Should dislodgment occur, reposition the lead to a new stable position.

- Removing the guide catheter and guide wire.** Follow these instructions once the lead is positioned.
 - Peel away the introducer sheath, if used.
 - While holding the lead and guide wire in place, remove the guide catheter using the method described in the guide catheter instructions for use.
 - Verify under fluoroscopy that the position of the lead tip or the radiopaque marker band proximal to the spiral fixation do not change during the removal of the guide catheter.
 - Hold the proximal end of the lead near the venous entry site, and remove the guide wire from the lead.

CAUTION: The guide wire must be removed before connecting the lead to the pulse generator. Do not complete implant with the guide wire inside the lead because it could cause lead perforation, or myocardial or coronary venous perforation. If the guide wire cannot be removed from the lead, withdraw the lead and guide wire together.

- Verify under fluoroscopy that the lead has not moved.

NOTE: Allow extra slack of the lead in the atrium for a strain relief to reduce the chance of dislodgment.

8. **Securing the lead.** After the electrodes are satisfactorily positioned, use the suture sleeve to secure the lead to achieve permanent hemostasis and lead stabilization. Suture sleeve tie-down techniques can vary with the lead insertion technique used. Consider the following warnings and precautions while securing the lead.

WARNING: Do not kink, twist, or braid the lead with other leads as doing so could cause lead insulation abrasion damage or conductor damage.

CAUTION: When ligating the vein, avoid stricture that is too tight. A tight stricture might damage the insulation or sever the vein. Avoid dislodging the distal tip during the anchoring procedure.

CAUTION: Do not suture directly over the lead body, as this may cause structural damage. Use the suture sleeve to secure the lead proximal to the venous entry site to prevent lead movement.

CAUTION: Avoid removing or cutting the suture sleeve from the lead. If removal of the suture sleeve is necessary, use caution as lead damage can occur.

CAUTION: Use of multiple suture sleeves has **NOT** been evaluated and is not recommended.

Percutaneous Implant Technique

- a. After the introducer sheath and the guide catheter have been removed, slide the suture sleeve deep into the tissue (Figure 10 Example of suture sleeve, percutaneous implant technique on page 31).

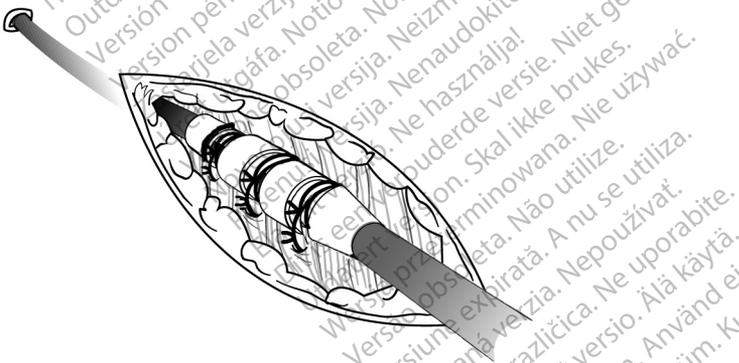

Figure 10. Example of suture sleeve, percutaneous implant technique

- b. Using at least two grooves, ligate the suture sleeve and then secure the suture sleeve and the lead to the fascia
- c. Check the suture sleeve after tie-down to demonstrate stability and lack of slippage by grasping the suture sleeve with fingers and trying to move the lead in either direction.

CAUTION: When implanting the lead via a subclavian puncture, allow slack in the lead between the suture sleeve and the venous entry site. This will help minimize flexing at the suture sleeve and interaction with the clavicle/first rib region.

Venous Cutdown Technique

- a. After the guide catheter has been removed, slide the suture sleeve into the vein past the distal groove.
- b. Ligate the vein around the suture sleeve to obtain hemostasis.
- c. Using the same groove, secure the lead and vein to the adjacent fascia (Figure 11 Example of suture sleeve, venous cutdown technique on page 32).

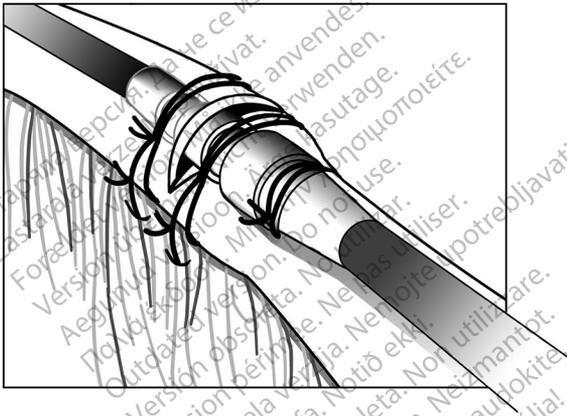

Figure 11. Example of suture sleeve, venous cutdown technique

- d. Use at least two grooves to secure the sleeve to the lead. Using a proximal groove, secure the sleeve and the lead to the adjacent fascia.
- e. Check the suture sleeve after tie-down to demonstrate stability and lack of slippage by grasping the suture sleeve with fingers and trying to move the lead in either direction.

NOTE: For stability, the sleeve may be secured to the lead first before securing the sleeve to the fascia.

9. **Connecting to a Pulse Generator.** Consult the applicable pulse generator physician's manual for more instructions for connecting lead terminals to the pulse generator.
 - Before connecting the lead to a pulse generator, ensure the guide wire is removed from the lead.
 - When the lead is secured at the venous entry site, use fluoroscopy to recheck the lead position, and re-test threshold measurements with a PSA or similar device.

- Grasp the terminal immediately distal to the terminal ring contacts and fully insert the lead terminal into the pulse generator port until the terminal pin is visible beyond the setscrew block. If the terminal pin is difficult to insert, verify the setscrew is completely retracted. Visualization of the green terminal pin insertion indicator beyond the setscrew block may be used to confirm that the terminal pin is fully inserted into the pulse generator port.

WARNING: When connecting the lead to the pulse generator, it is very important that proper connections are made. An improper connection could result in loss of therapy or inappropriate therapy.

WARNING: When implanting a system which uses both a DF4-LLHH/LLHO¹⁰ and IS4-LLLL¹¹ lead, ensure that the leads are inserted and secured in the appropriate ports. Inserting a lead into an incorrect port will result in unanticipated device behavior (potentially leaving the patient without effective therapy).

CAUTION: Insert the lead terminal straight into the lead port. Do not bend the lead near the lead-header interface. Improper insertion can cause insulation or connector damage.

NOTE: If necessary, lubricate the entire lead terminal (area shown in Figure 12 IS4 Lead Terminal on page 33) sparingly with sterile water or sterile mineral oil to make insertion easier.



Figure 12. IS4 Lead Terminal

- After the setscrew is tightened, apply gentle traction to the lead by grasping the labeled area of the lead body to ensure a secure connection.
 - Evaluate the electrical performance of the lead after connection to the pulse generator to confirm full insertion of the lead terminal and a good electrical connection.
- NOTE:** If the lead terminal will not be connected to a pulse generator at the time of lead implantation, you must cap the connector before closing the pocket incision. The lead cap is designed specifically for this purpose. Place a suture around the lead cap to keep it in place.
- Giving consideration to patient anatomy and pulse generator size and motion, gently coil any excess lead and place adjacent to the pulse generator. It is important to place the lead into the pocket in a manner that minimizes lead tension, twisting, sharp angles, and/or pressure.

10. DF4 refers to the international standard ISO 27186:2010.

11. IS4 refers to the international standard ISO 27186:2010.

Electrical Performance

1. Evaluate the lead signals using the pulse generator.
2. Place the pulse generator into the implant pocket as indicated in the pulse generator physician's manual. Also refer to the instructions in this manual.
3. Evaluate the lead signals by viewing the real-time EGM. Consider the following:
 - The signal from the implanted lead should be continuous and without artifact, similar to a body-surface ECG.
 - A discontinuous signal may indicate a lead fracture or an otherwise damaged lead, or an insulation break that would necessitate lead replacement.
 - Inadequate signals may result in altered LV therapy.
4. Test for extracardiac or phrenic nerve stimulation by pacing the lead at a high voltage output, using professional medical judgment to select the output voltage. Adjust the lead configurations and lead position as necessary. Testing should be conducted for all final lead placements.

Tunneling the Lead

Follow these steps if tunneling the lead:

1. Allow slack on the lead for strain relief on the lateral side of the suture sleeve near the venous entry site when securing the leads to body tissue. This will prevent lead dislodgment caused by the weight of the pulse generator or upper extremity movement.

WARNING: Use caution handling the lead terminal when the Connector Tool is not present on the lead. Do not directly contact the lead terminal with any surgical instruments or electrical connections such as PSA (alligator) clips, ECG connections, forceps, hemostats, and clamps. This could damage the lead terminal, possibly compromising the sealing integrity and result in loss of therapy or inappropriate therapy.

2. Remove the stylet and Connector Tool.

NOTE: *A compatible tunneling tip is recommended for use with this lead if the pulse generator is implanted away from the vein insertion site. Refer to the instructions for use for the tunneling tip and/or tunneler kit if one is being used. When using a compatible tunneling tip, do not cap the lead.*

3. Cap the lead terminal if a tunneling tip and/or tunneler kit is not used. Grip the terminal pin with a hemostat, or equivalent.

WARNING: Do not contact any other portion of the lead terminal, other than the terminal pin, even when the lead cap is in place.

4. Gently tunnel the lead subcutaneously from the vein insertion site to the implant pocket.

CAUTION: Tunnel the lead from the chest area to the pulse generator implant site. Do not tunnel the lead from the pulse generator implant site to the chest area because this can damage the electrodes or lead body or both by permanently stretching the lead.

CAUTION: When tunneling the lead, take precautions not to place excessive tension on the lead. This can cause either structural weakness and/or conductor discontinuity.

CAUTION: After tunneling, re-evaluate the lead to verify that no significant change in signals or damage to the lead has occurred during the tunneling procedure. Reattach the Connector Tool and repeat the steps in Evaluating Lead Performance.

NOTE: *If the tunneling procedure must be delayed, cap the lead terminal and form a temporary pocket for the coiled lead. Capping the terminal protects it and prevents body fluids from entering the lumen of the lead.*

5. Reattach the lead terminals to the pulse generator and evaluate lead signals with the pulse generator as previously described.
 - If the measurements are unacceptable, check the electrical connections. A discontinuous or abnormal signal may indicate dislodgment, a loose connection, or lead damage.
 - If necessary, reposition the lead electrodes until acceptable values are obtained. To reposition the lead, carefully withdraw the tunneled portion back to the venous entry site. Release the permanent ligatures and reposition the lead using procedures previously discussed.

POSTIMPLANT

Postimplant Evaluation

Perform follow-up evaluation as recommended in the applicable pulse generator physician's manual.

CAUTION: For some patients, lead performance at implant may not predict performance in the chronic state. Therefore, it is recommended that post-implant lead evaluation follow-up be done at the routine pulse generator follow-up and additionally as necessary.

WARNING: Ensure that an external defibrillator and medical personnel skilled in CPR are present during post-implant device testing should the patient require external rescue.

NOTE: *Chronic repositioning of the lead may be difficult because of body fluid or fibrotic tissue intrusion.*

Explantation

NOTE: *Return all explanted pulse generators and leads to Boston Scientific. Examination of explanted pulse generators and leads can provide information for continued improvement in system reliability and warranty considerations.*

WARNING: Do not reuse, reprocess, or resterilize. Reuse, reprocessing, or resterilization may compromise the structural integrity of the device and/or lead to device failure which, in turn, may result in patient injury, illness, or death. Reuse, reprocessing, or resterilization may also create a risk of contamination of the device and/or cause patient infection or cross-infection, including, but not

limited to, the transmission of infectious disease(s) from one patient to another. Contamination of the device may lead to injury, illness, or death of the patient.

Contact Boston Scientific when any of the following occur:

- When a product is removed from service.
- In the event of patient death (regardless of cause), along with an autopsy report, if performed.
- For other observation or complications reasons.

NOTE: *Disposal of explanted pulse generators and/or leads is subject to applicable laws and regulations. For a Returned Product Kit, contact Boston Scientific using the information on the back cover.*

Consider the following items when explanting and returning the pulse generator and/or lead:

- Interrogate the pulse generator and print a comprehensive report.
- Deactivate the pulse generator before explantation.
- Disconnect the leads from the pulse generator.
- If leads are explanted, attempt to remove them intact, and return them regardless of condition. Do not remove leads with hemostats or any other clamping tool that may damage the leads. Resort to tools only if manual manipulation cannot free the lead.
- Wash, but do not submerge, the pulse generator and leads to remove body fluids and debris using a disinfectant solution. Do not allow fluids to enter the pulse generator's lead ports.
- Use a Boston Scientific Returned Product Kit to properly package the pulse generator and/or lead, and send it to Boston Scientific.

SPECIFICATIONS

Specifications (Nominal)

Table 8. Lead Tip Configuration, Length, and Model Number

Tip Configuration	Length (cm)	Model
Straight	86	4671
	95	4672
Spiral S	86	4674
	95	4675
Spiral L	86	4677
	95	4678

Table 9. Specifications (Nominal)

Terminal type	IS4
Compatibility	Pulse generators with an IS4–LLLL port
Electrode Configuration	Quadripolar
Fixation — Straight models	Tined
Fixation — Spiral models	Tined and 3 dimensional spiral
Tip to radiopaque marker band distal edge	Spiral S models 4674, 4675 = 6.0 cm Spiral L models 4677, 4678 = 7.5 cm
Recommended introducer size	Determined by guide catheter size
Recommended guide catheter size	0.081 in. (2.06 mm) minimum inner diameter
Electrode Dimensions:	
Distal LV Tip Electrode 1 (E1) surface area	4.1 mm ²
LV Ring Electrode 2 (E2) surface area	8.3 mm ²
LV Ring Electrode 3 (E3) surface area	8.3 mm ²
LV Ring Electrode 4 (E4) surface area	8.3 mm ²
Electrode spacing (LV Tip Electrode 1 = E1) (LV Ring Electrode 2 = E2) (LV Ring Electrode 3 = E3) (LV Ring Electrode 4 = E4)	<u>Straight models 4671, 4672</u> Distal Tip to E1 = 3 mm E1 to E2 = 12 mm E2 to E3 = 12 mm E3 to E4 = 12 mm <u>Spiral S models 4674, 4675</u> Distal Tip to E1 = 3 mm E1 to E2 = 20.5 mm E2 to E3 = 7.5 mm E3 to E4 = 7.5 mm <u>Spiral L models 4677, 4678</u> Distal Tip to E1 = 3 mm E1 to E2 = 35.5 mm E2 to E3 = 7.5 mm E3 to E4 = 7.5 mm
Diameter:	
Insertion	1.8 mm (5.4F)
Proximal body	1.7 mm (5.2F)
Distal body	1.3 mm (3.9F)
Distal tip	0.9 mm (2.6F)

Table 9. Specifications (Nominal) (continued)

Material:	
External insulation	Polyurethane and silicone
Internal insulation	Polyurethane, silicone, ETFE
Tines	Silicone
Terminal insulation	Tecothane and PEEK
Terminal ring contact	MP35N™ a
IS4 terminal pin contact	MP35N™ a
Electrodes	IROX (iridium oxide) coated Platinum iridium (Pt/Ir) substrate
Conductor type	Coil (pin-to-distal electrode) Cable (terminal rings to proximal electrodes)
Steroid	0.43 mg dexamethasone acetate
Radiopaque markers	Pt/Ir
Suture sleeve	Radiopaque white silicone rubber
Maximum Lead Conductor Resistance:	
From terminal pin to distal LV Tip Electrode 1 (E1)	120 Ω
From terminal ring to LV Ring Electrode 2 (E2)	35 Ω
From terminal ring to LV Ring Electrode 3 (E3)	35 Ω
From terminal ring to LV Ring Electrode 4 (E4)	35 Ω

a. MP35N is a trademark of SPS Technologies, Inc.

Lead Introducer

Table 10. Lead introducer

Recommended lead introducer is determined by guide catheter size
Recommended guide catheter size: 0.081 in. (0.21 cm) minimum inner diameter

Symbols on Packaging

The following symbols may be used on packaging and labeling (Table 11 Symbols on packaging on page 39):

Table 11. Symbols on packaging

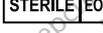
Symbol	Description
	Reference number
	Serial number
	Use by
	Lot number
	Date of manufacture
	Sterilized using ethylene oxide
	Do not resterilize
	Do not reuse
	Do not use if package is damaged
	Consult instructions for use on this website: www.bostonscientific-elabeling.com
	CE mark of conformity with the identification of the notified body authorizing use of the mark
	Opening instruction
	Authorized Representative in the European Community
	Manufacturer
	Australian Sponsor Address
	MR Conditional

Остаряла версия. Да не се използва.
Zastaralá verze. Nepoužívat.
Forældet version. Må ikke anvendes.
Version überholt. Nicht verwenden.
Version up-to-date. Μην την χρησιμοποιείτε.
Παλιά έκδοση. Μην την χρησιμοποιείτε.
Outdated version. Do not use.
Version obsolete. Ärge kasutage.
Version périmée. Ne pas utiliser.
Zastarjela verzija. Nemojte upotrebljavati.
Úrejt útgáfa. No utilitzar.
Versione obsoleta. Ne utiliziser.
Novecojsi verzija. Nenaudokite.
Pasenusi verzija. Non utilizzare.
Elavult verzió. Neizmantot.
Dit is een verouderde versie. Niet gebruiken.
Utdatert versija. Nie używać.
Wersja przeterminowana. Nie używać.
Versão obsoleta. A nu se utiliza.
Versiune expirată. Ne uporabite.
Zastarana verzija. Nepoužívat.
Zastarela različica. Ne uporabite.
Vanhentunut versio. Älä käytä.
Föråldrad version. Använd ej.
Güncel olmayan sürüm. Kullanmayın.

Остаряла версия. Да не се използва.
Zastaralá verze. Nepoužívat.
Forældet version. Må ikke anvendes.
Version überholt. Nicht verwenden.
Version up-to-date. Μην την χρησιμοποιείτε.
Παλιά έκδοση. Μην την χρησιμοποιείτε.
Outdated version. Do not use.
Version obsolete. Ärge kasutage.
Version périmée. Ne pas utiliser.
Zastarjela verzija. Nemojte upotrebljavati.
Úrejt utgáfa. No utilitzar.
Versione obsoleta. Ne utiliziser.
Novecojsi verzija. Nenaudokite.
Pasenusi versió. Non utilizzare.
Elavult verzió. Neizmantot.
Dit is een verouderde versie. Niet gebruiken.
Utdatert versija. Nie używać.
Wersja przeterminowana. Nie używać.
Versão obsoleta. Não utilize.
Versiune expirată. A nu se utiliza.
Zastaraná verzija. Nepoužívat.
Zastarela različica. Ne uporabite.
Vanhentunut versio. Älä käytä.
Föråldrad version. Använd ej.
Güncel olmayan sürüm. Kullanmayın.

Остаряла версия. Да не се използва.
Zastaralá verze. Nepoužívat.
Forældet version. Må ikke anvendes.
Version überholt. Nicht verwenden.
Version up-to-date. Μην την χρησιμοποιείτε.
Παλιά έκδοση. Μην την χρησιμοποιείτε.
Outdated version. Do not use.
Version obsolete. Ärge kasutage.
Version périmée. Ne pas utiliser.
Zastarjela verzija. Nemojte upotrebljavati.
Versione obsoleta. Ne utilizat.
Úrejt utgáfa. Notið ekki.
Novécojusi versija. Nenaudokite.
Pasenusi versija. Ne utilizare.
Elavult verzió. Ne használját.
Dit is een verouderde versie. Niet gebruiken.
Utdatert versjon. Skal ikke brukes.
Wersja przeterminowana. Nie używać.
Versão obsoleta. Não utilize.
Versiune expirată. A nu se utiliza.
Zastaraná verzija. Nepoužívat.
Zastarela različica. Ne uporabite.
Vanhentunut versio. Älä käytä.
Föråldrad version. Använd ej.
Güncel olmayan sürüm. Kullanmayın.

Остаряла версия. Да не се използва.
Zastaralá verze. Nepoužívat.
Forældet version. Må ikke anvendes.
Version überholt. Nicht verwenden.
Version up-to-date. Μην την χρησιμοποιείτε.
Παλιά έκδοση. Μην την χρησιμοποιείτε.
Outdated version. Do not use.
Version obsolete. Ärge kasutage.
Version périmée. Ne pas utiliser.
Zastarjela verzija. Nemojte upotrebljavati.
Versione obsoleta. Ne utilizat.
Úrejt útgáfa. No utilitzar.
Novécojusi verzija. Ne naudokite.
Pasenusi versija. Ne naudokite.
Elavult verzió. Ne használja!
Dit is een verouderde versie. Niet gebruiken.
Utdatert versjon. Skal ikke brukes.
Wersja przeterminowana. Nie używać.
Versão obsoleta. Não utilize.
Versiune expirată. A nu se utiliza.
Zastaraná verzija. Nepoužívat.
Zastarela različica. Ne uporabite.
Vanhentunut versio. Älä käytä.
Föråldrad version. Använd ej.
Güncel olmayan sürüm. Kullanmayın.

Boston Scientific



Boston Scientific Corporation
4100 Hamline Avenue North
St. Paul, MN 55112-5798 USA

EC REP

Guidant Europe NV/SA; Boston Scientific
Green Square, Lambroekstraat 5D
1831 Diegem, Belgium

AUS

Boston Scientific (Australia) Pty Ltd
PO Box 332
BOTANY NSW 1455 Australia
Free Phone 1 800 676 133
Free Fax 1 800 836 666

www.bostonscientific.com

1.800.CARDIAC (227.3422)

+1.651.582.4000

© 2018 Boston Scientific Corporation or its affiliates.

All rights reserved.
92035847-019 EN Europe 2020-01

CE 2797

Authorized 2013

