

PHYSICIAN'S TECHNICAL MANUAL

**VISIONIST™, VISIONIST™ X4,  
VALITUDE™, VALITUDE™ X4,  
INLIVEN™, INTUA™, INVIVE™**

CARDIAC RESYNCHRONIZATION THERAPY  
PACEMAKER

**REF** U225, U226, U228, U125, U128, W274, W275, W272, W273, W172, W173

Остаряла версия. Да не се използва.  
Zastaralá verze. Nepoužívat.  
Forældet version. Må ikke anvendes.  
Version überholt. Nicht verwenden.  
Aegunud versioön. Äрге kasutage.  
Παλιά έκδοση. Μην την χρησιμοποιείτε.  
Outdated version. Do not use.  
Version obsoleta. Nemojte upotrebljavati.  
Zastarjela verzija. Ne pas utiliser.  
Ürelt útgáfa. Notið ekki.  
Versione obsoleta. Nemojte upotrebljavati.  
Novecojsi versija. Non utilizzare.  
Pasenusi versija. Neizmantoť.  
Elavult verzió. Ne használja!  
Utdatert versjon. Nenaudokite.  
Wersja przeterminowana. Niet gebruiken.  
Versão obsoleta. Não utilize.  
Zastarana verzija. Ne uporabite.  
Zastarela verzija. Ne uporabite.  
Vanhentunut versio. Älä käytä.  
Föråldrad version. Använd ej.  
Güncel olmayan sürüm. Kullanmayın.

# Table of Contents

|  |    |
|--|----|
| Additional Information .....                             | 1  |
| Device Description .....                                 | 1  |
| Related Information .....                                | 4  |
| Indications and Usage .....                              | 5  |
| Contraindications .....                                  | 6  |
| Warnings .....   | 6  |
| Precautions .....  | 9  |
| Supplemental Precautionary Information .....             | 23 |
| Post-Therapy Pulse Generator Follow Up .....             | 23 |
| Magnetic Resonance Imaging (MRI) .....                   | 24 |
| Minimizing Pacemaker/S-ICD Interaction .....             | 27 |
| Transcutaneous Electrical Nerve Stimulation (TENS) ..... | 29 |
| Electrocautery and Radio Frequency (RF) Ablation .....   | 30 |
| Ionizing Radiation .....                                 | 32 |
| Elevated Pressures .....                                 | 33 |
| Potential Adverse Events .....                           | 34 |
| Mechanical Specifications .....                          | 37 |
| Items Included in Package .....                          | 41 |
| Symbols on Packaging .....                               | 41 |
| Characteristics as Shipped .....                         | 46 |
| X-Ray Identifier .....                                   | 48 |
| Pulse Generator Longevity .....                          | 49 |
| Warranty Information .....                               | 54 |
| Product Reliability .....                                | 54 |
| Patient Counseling Information .....                     | 55 |
| Patient Handbook .....                                   | 56 |

|  |    |
|--|----|
| Lead Connections .....                         | 56 |
| Implanting the Pulse Generator .....           | 61 |
| Check Equipment.....                           | 61 |
| Interrogate and Check the Pulse Generator..... | 62 |
| Implant the Lead System.....                   | 62 |
| Take Baseline Measurements.....                | 64 |
| Form the Implantation Pocket.....              | 67 |
| Connect the Leads to the Pulse Generator.....  | 68 |
| Evaluate Lead Signals.....                     | 72 |
| Program the Pulse Generator.....               | 74 |
| Implant the Pulse Generator.....               | 75 |
| Complete and Return the Implantation Form..... | 76 |
| Bidirectional Torque Wrench.....               | 76 |
| Follow Up Testing.....                         | 78 |
| Explantation.....                              | 80 |

## ADDITIONAL INFORMATION

For additional reference information, go to [www.bostonscientific-elabeling.com](http://www.bostonscientific-elabeling.com).

## DEVICE DESCRIPTION

This manual contains information about the VISIONIST, VALITUDE, INLIVEN, INTUA, and INVIVE families of cardiac resynchronization therapy pacemakers (CRT-PS) (specific models are listed in "Mechanical Specifications" on page 37).

**NOTE:** *This manual may contain information for model numbers that are not currently approved for sale in all geographies. For a complete list of model numbers approved in your geography, consult with your local sales representative. Some model numbers may contain fewer features; for those devices, disregard information about unavailable features. References to names of non-quadripolar devices also apply to the corresponding quadripolar devices. References to "ICD" include all types of ICDs (e.g., ICD, CRT-D, S-ICD).*

## Therapies

These pulse generators provide a variety of therapies, including:

- Cardiac Resynchronization Therapy (CRT), which treats heart failure by resynchronizing ventricular contractions through biventricular electrical stimulation
- Bradycardia pacing, including adaptive rate pacing, to detect and treat bradyarrhythmias

## Leads

The pulse generator has independently programmable outputs and accepts one or more of the following leads, depending on the model:

- One IS-1<sup>1</sup> unipolar or bipolar atrial lead
- One IS-1 unipolar or bipolar right ventricular lead

---

1. IS-1 refers to the international standard ISO 5841-3:2013.

- One LV-1 unipolar or bipolar left ventricular lead
- One IS-1 unipolar or bipolar left ventricular lead
- One IS4<sup>2</sup> quadripolar left ventricular lead

**NOTE:** Use of an RA or RV unipolar lead with an ImageReady pulse generator is inconsistent with the Conditions of Use required for MR Conditional status. Refer to the ImageReady MR Conditional Pacing System MRI Technical Guide for information about MRI scanning.

The pulse generator and the leads constitute the implantable portion of the pulse generator system.

**NOTE:** Use of Boston Scientific MR Conditional leads is required for an implanted system to be considered MR Conditional. Refer to the MRI Technical Guide for model numbers of pulse generators, leads, accessories, and other system components needed to satisfy the Conditions of Use.

### Programming System

These pulse generators can be used with either the Model 3120 ZOOM LATITUDE Programming System or the Model 3300 LATITUDE Programming System. The LATITUDE Programming System is the external portion of the pulse generator system.

The 3120 ZOOM LATITUDE Programming System includes:

- Model 3120 Programmer/Recorder/Monitor (PRM)
- Model 3140 ZOOM Wireless Transmitter
- Model 2869 ZOOMVIEW Software Application
- Model 6577 Accessory Telemetry Wand

---

2. IS4 refers to the international standard ISO 27186:2010.

The 3300 LATITUDE Programming System includes:

- Model 3300 Programmer
- Model 3869 Software Application
- Model 6395 Accessory Telemetry Wand

You can use the programming system to do the following:

- Interrogate the pulse generator
- Program the pulse generator to provide a variety of therapy options
- Access the pulse generator's diagnostic features
- Perform noninvasive diagnostic testing
- Access therapy history data
- Store a 12 second trace of the ECG/EGM display from any screen
- Access an interactive Demonstration Mode or Patient Data Mode without the presence of a pulse generator
- Print patient data including pulse generator therapy options and therapy history data
- Save patient data

You can program the pulse generator using two methods: automatically using Indications-Based Programming (IBP) or manually.

**NOTE:** Multiple Programming Systems are available for use based on software and regional availability, and they include different programming devices such as the Model 3120 Programmer/Recorder/Monitor (PRM) and the Model 3300 Programmer. In this manual, the terms PRM and Programmer are used interchangeably to refer to the programming device.

The Model 3300 Programming System has the same basic capabilities and intended use as the Model 3120 Programming System. Differences between the programming systems include software application model numbers, networking and printing capabilities, on-device keys, and data storage options. Refer to the 3300 Programming System's family of operator's manuals for specific information.

## RELATED INFORMATION

Refer to the lead's instruction manual for implant information, general warnings and precautions, indications, contraindications, and technical specifications. Read this material carefully for implant procedure instructions specific to the chosen lead configurations.

Refer to the PRM system Operator's Manual or ZOOM Wireless Transmitter Reference Guide for specific information about the PRM or ZOOM Wireless Transmitter such as setup, maintenance, and handling.

Refer to the ImageReady MR Conditional Pacing System MRI Technical Guide for information about MRI scanning.

LATITUDE NXT is a remote monitoring system that provides pulse generator data for clinicians. These pulse generators are designed to be LATITUDE NXT enabled; availability varies by region.

LATITUDE NXT is available for the following devices: VISIONIST, VALITUDE, INLIVEN, INTUA, INVIVE.

- Physicians/Clinicians—LATITUDE NXT enables you to periodically monitor both patient and device status remotely and automatically. The LATITUDE NXT system provides patient data that can be used as part of the clinical evaluation of the patient.
- Patients—A key component of the system is the LATITUDE Communicator, an easy-to-use, in-home monitoring device. The Communicator automatically reads implanted device data from a compatible



Boston Scientific pulse generator at times scheduled by the physician. The Communicator sends this data to the LATITUDE NXT secure server. The LATITUDE NXT server displays the patient data on the LATITUDE NXT Web site, which is readily accessible over the Internet to authorized physicians and clinicians.

Refer to the LATITUDE NXT Clinician Manual for more information.

## **INTENDED AUDIENCE**

This literature is intended for use by professionals trained or experienced in device implant and/or follow-up procedures.

## **INDICATIONS AND USAGE**

Boston Scientific cardiac resynchronization therapy pacemakers (CRT-Ps) are indicated for patients who have symptomatic congestive heart failure including left ventricular dysfunction and wide QRS; and/or one or more of the following conditions:

- Symptomatic paroxysmal or permanent second- or third-degree AV block
- Symptomatic bilateral bundle branch block
- Symptomatic paroxysmal or transient sinus node dysfunction with or without associated AV conduction disorders (i.e., sinus bradycardia, sinus arrest, sinoatrial [SA] block)
- Bradycardia-tachycardia syndrome, to prevent symptomatic bradycardia or some forms of symptomatic tachyarrhythmias
- Neurovascular (vaso-vagal) syndromes or hypersensitive carotid sinus syndromes

Atrial tracking modes are also indicated for patients who may benefit from maintenance of AV synchrony. Dual-chamber modes are specifically indicated for treatment of the following:

- Conduction disorders that require restoration of AV synchrony, including varying degrees of AV block

- VVI intolerance (i.e., pacemaker syndrome) in the presence of persistent sinus rhythm
- Low cardiac output or congestive heart failure secondary to bradycardia

Adaptive-rate pacing is indicated for patients exhibiting chronotropic incompetence and who would benefit from increased pacing rates concurrent with increases in minute ventilation and/or physical activity.

## CONTRAINDICATIONS

These Boston Scientific pulse generators have the following contraindications:

- This device is contraindicated in patients who have a separate implanted cardioverter defibrillator (ICD) with transvenous leads.
- Unipolar pacing or use of the MV/Respiratory Sensor with a Subcutaneous Implantable Cardioverter Defibrillator (S-ICD) is contraindicated because it may cause inappropriate therapy or inhibition of appropriate S-ICD therapy.
- Minute Ventilation is contraindicated in patients with both unipolar atrial and ventricular leads
- Single-chamber atrial pacing is contraindicated in patients with impaired AV nodal conduction.
- Atrial tracking modes are contraindicated in patients with chronic refractory atrial tachyarrhythmias (atrial fibrillation or flutter), which might trigger ventricular pacing.
- Asynchronous pacing is contraindicated in the presence (or likelihood) of competition between paced and intrinsic rhythms.

## WARNINGS

### General

- **Labeling knowledge.** Read this manual thoroughly before implantation to avoid damage to the pulse generator and/or lead. Such damage can result in patient injury or death.

- **For single patient use only.** Do not reuse, reprocess, or resterilize. Reuse, reprocessing, or resterilization may compromise the structural integrity of the device and/or lead to device failure which, in turn, may result in patient injury, illness, or death. Reuse, reprocessing, or resterilization may also create a risk of contamination of the device and/or cause patient infection or cross-infection, including, but not limited to, the transmission of infectious disease(s) from one patient to another. Contamination of the device may lead to injury, illness, or death of the patient.
- **Backup defibrillation protection.** Always have external defibrillation equipment available during implant and electrophysiologic testing. If not terminated in a timely fashion, an induced ventricular tachyarrhythmia can result in the patient's death.
- **Separate pulse generator.** Using multiple pulse generators could cause pulse generator interaction, resulting in patient injury or a lack of therapy delivery. Test each system individually and in combination to help prevent undesirable interactions ("Minimizing Pacemaker/S-ICD Interaction" on page 27).
- **Safety Core operation.** In response to applicable nonrecoverable or repeat fault conditions, the pulse generator will switch irreversibly to Safety Core operation. Safety Core pacing may be unipolar, which may interact with an ICD ("Minimizing Pacemaker/S-ICD Interaction" on page 27). Safety Core behavior is affected by MRI Protection Mode. Refer to "Magnetic Resonance Imaging (MRI)" on page 24.

## Handling

- **Do not kink leads.** Do not kink, twist, or braid the lead with other leads as doing so could cause lead insulation abrasion damage or conductor damage.
- **Handling the lead without Connector Tool.** For leads that require the use of a Connector Tool, use caution handling the lead terminal when the Connector Tool is not present on the lead. Do not directly contact the lead terminal with any surgical instruments or electrical connections such as PSA (alligator) clips, ECG connections, forceps, hemostats, and clamps. This could damage the lead terminal, possibly compromising the sealing integrity and result in loss of therapy or inappropriate therapy, such as a short within the header.

- **Handling the terminal while tunneling.** Do not contact any other portion of the IS4–LLLL lead terminal, other than the terminal pin, even when the lead cap is in place.

### Programming and Device Operations

- **Atrial tracking modes.** Do not use atrial tracking modes in patients with chronic refractory atrial tachyarrhythmias. Tracking of atrial arrhythmias could result in ventricular tachyarrhythmias.
- **Atrial-only modes.** Do not use atrial-only modes in patients with heart failure because such modes do not provide CRT.
- **Lead Safety Switch.** Lead Safety Switch should be programmed Off for patients with an ICD. Unipolar pacing due to Lead Safety Switch is contraindicated for patients with an ICD.
- **Automatic Lead Recognition.** Automatic Lead Recognition should be programmed to Off before implant for patients with an ICD. Unipolar pacing is contraindicated for patients with an ICD.
- **RAAT testing.** Unipolar pacing due to RAAT is contraindicated and should be programmed off for patients with an ICD. The RAAT feature performs automatic threshold testing in a unipolar pacing configuration.
- **Ventricular sensing.** Left ventricular lead dislodgement to a position near the atria can result in atrial oversensing and left ventricular pacing inhibition.
- **Sensitivity settings and EMI.** If programmed to a fixed atrial Sensitivity value of 0.15 mV, or a fixed sensitivity value of 2.0 mV or less in a unipolar lead configuration in any chamber, the pulse generator may be more susceptible to electromagnetic interference. This increased susceptibility should be taken into consideration when determining the follow-up schedule for patients requiring such a setting.

### Post-Implant

- **Protected environments.** Advise patients to seek medical guidance before entering environments that could adversely affect the operation of the active implantable medical device, including areas protected by a warning notice that prevents entry by patients who have a pulse generator.

- **Magnetic Resonance Imaging (MRI) exposure.** VISIONIST X4 and VALITUDE X4 devices are considered MR Conditional. For these devices, unless all of the MRI Conditions of Use are met, MRI scanning of the patient does not meet MR Conditional requirements for the implanted system. Significant harm to or death of the patient and/or damage to the implanted system may result. *All other devices covered by this manual are not MR conditional.* Do not expose patients with non-MR Conditional devices to MRI scanning. Strong magnetic fields may damage the pulse generator and/or lead system, possibly resulting in injury to or death of the patient.

For potential adverse events applicable when the Conditions of Use are met or not met, refer to the MRI Technical Guide. For additional warnings, precautions, and Conditions of Use, refer to "Magnetic Resonance Imaging (MRI)" on page 24.

- **Diathermy.** Do not subject a patient with an implanted pulse generator and/or lead to diathermy since diathermy may cause fibrillation, burning of the myocardium, and irreversible damage to the pulse generator because of induced currents.

## PRECAUTIONS

### Clinical Considerations

- **STAT PACE.** STAT PACE will initiate unipolar pacing. Unipolar pacing due to STAT PACE may cause inappropriate therapy or inhibition of appropriate S-ICD therapy.
- **Pacemaker-mediated tachycardia (PMT).** Programming minimum PVARP less than retrograde V–A conduction may increase the likelihood of a PMT.
- **MV Sensor modes.** The safety and efficacy of the MV Sensor modes have not been clinically established in patients with abdominal implant sites.
- **MV Sensor mode performance.** MV Sensor performance may be adversely affected under transient conditions such as pneumothorax, pericardial effusion, or pleural effusion. Consider programming the MV Sensor Off until these conditions are resolved.

- **Adaptive-rate modes.** Adaptive-rate modes based completely or in part on MV might be inappropriate for patients who can achieve respiratory cycles shorter than one second (greater than 60 breaths per minute). Higher respiration rates attenuate the impedance signal, which diminishes the MV rate response (i.e., the pacing rate will drop toward the programmed LRL).

Adaptive-rate modes based completely or in part on MV should not be used for patients with:

- An ICD
- Unipolar leads—for MV detection, a bipolar lead is required in either the atrium or ventricle
- A lead other than a bipolar transvenous lead—MV measurement has only been tested with a bipolar transvenous lead
- A mechanical ventilator—use of the ventilator might result in an inappropriate MV Sensor-driven rate
- **Rate Adaptive Pacing in Heart Failure Patients.** The clinical benefit of Rate Adaptive Pacing in heart failure patients has not been studied. Rate Adaptive Pacing should be used with medical discretion if the patient develops an indication such as chronotropic incompetence. Patients with heart failure may have hemodynamic compromise at rapid sensor-driven rates, and the physician may wish to program less aggressive rate adaptive parameters in accordance with patient condition. Heart failure-related respiratory changes in patient's minute ventilation (MV) may inappropriately increase paced rate to the upper rate (MSR), for instance during heart failure at rest. If this occurs, physicians may consider turning off rate responsive pacing or modifying the Rate Adaptive Pacing settings. Rate Adaptive Pacing may be helpful for heart failure patients with coexisting bradyarrhythmic conditions.

## Sterilization and Storage

- **If package is damaged.** The blister trays and contents are sterilized with ethylene oxide gas before final packaging. When the pulse generator and/or lead is received, it is sterile provided the container is intact. If the packaging is wet, punctured, opened, or otherwise damaged, return the pulse generator and/or lead to Boston Scientific.

- **If device is dropped.** Do not implant a device which has been dropped while outside of its intact shelf package. Do not implant a device which has been dropped from a height of more than 24 inches (61 cm) while within its intact shelf package. Sterility, integrity, and/or function cannot be guaranteed under these conditions, and the device should be returned to Boston Scientific for inspection.
- **Storage temperature and equilibration.** Recommended storage temperatures are 0°C–50°C (32°F–122°F). Allow the device to reach a proper temperature before using telemetry communication capabilities, programming, or implanting the device because temperature extremes may affect initial device function.
- **Device storage.** Store the pulse generator in a clean area away from magnets, kits containing magnets, and sources of EMI to avoid device damage.
- **Use by date.** Implant the pulse generator and/or lead before or on the USE BY date on the package label because this date reflects a validated shelf life. For example, if the date is January 1, do not implant on or after January 2.

## Implantation

- **Expected benefits.** Determine whether the expected device benefits provided by programmable options outweigh the possibility of more rapid battery depletion.
- **Evaluate patient for surgery.** There may be additional factors regarding the patient's overall health and medical condition that, while not related to device function or purpose, could render the patient a poor candidate for implantation of this system. Cardiac health advocacy groups may have published guidelines that may be helpful in conducting this evaluation.
- **Lead compatibility.** Prior to implantation, confirm the lead-to-pulse generator compatibility. Using incompatible leads and pulse generators can damage the connector and/or result in potential adverse consequences, such as undersensing of cardiac activity or failure to deliver necessary therapy.
- **Telemetry wand.** Make sure a sterile telemetry wand is available should loss of ZIP telemetry occur. Verify that the wand can easily be connected to the programmer and is within reach of the pulse generator.

- **Line-powered equipment.** Exercise extreme caution if testing leads using line-powered equipment because leakage current exceeding 10  $\mu\text{A}$  can induce ventricular fibrillation. Ensure that any line-powered equipment is within specifications.
- **Replacement device.** Implanting a replacement device in a subcutaneous pocket that previously housed a larger device may result in pocket air entrapment, migration, erosion, or insufficient grounding between the device and tissue. Irrigating the pocket with sterile saline solution decreases the possibility of pocket air entrapment and insufficient grounding. Suturing the device in place reduces the possibility of migration and erosion.
- **Do not bend the lead near the lead-header interface.** Insert the lead terminal straight into the lead port. Do not bend the lead near the lead-header interface. Improper insertion can cause insulation or connector damage.
- **Absence of a lead.** The absence of a lead or plug in a lead port may affect device performance. If a lead is not used, be sure to properly insert a plug in the unused port, and then tighten the setscrew onto the plug.
- **Dual chamber device without a functional RV lead.** If a dual-chamber device is programmed to AAI(R), ensure that a functional RV lead is present. In the absence of a functional RV lead, programming to AAI(R) may result in undersensing or oversensing.
- **Electrode connections.** Do not insert a lead into the pulse generator connector without taking the following precautions to ensure proper lead insertion:
  - Insert the torque wrench into the preslit depression of the seal plug before inserting the lead into the port, to release any trapped fluid or air.
  - Visually verify that the setscrew is sufficiently retracted to allow insertion. Use the torque wrench to loosen the setscrew if necessary.
  - Fully insert each lead into its lead port and then tighten the setscrew onto the terminal pin.



- **Do not suture directly over lead.** Do not suture directly over the lead body, as this may cause structural damage. Use the suture sleeve to secure the lead proximal to the venous entry site to prevent lead movement.
- **MV Sensor.** Do not program the MV Sensor to On until after the pulse generator has been implanted and system integrity has been tested and verified.
- **Programming MV Sensor for respiratory disorders or abnormal breathing.** For patients with respiratory disorders or abnormal breathing patterns, the physician should use medical judgment when programming the MV Sensor to On. To mitigate inappropriate sensor-driven rates, the physician may evaluate the rate response and consider a lower Response Factor.
- **Diaphragmatic stimulation.** Patients should be tested for diaphragmatic stimulation by pacing the LV lead through the pulse generator at 7.5 V and adjusting the lead configurations and lead position as necessary. PSA testing at higher outputs (e.g., 10.0 V) may also be considered to better characterize stimulation margins. The probability of diaphragmatic stimulation increases when a pacing system includes an LV lead because of this lead's proximity to the phrenic nerve.

#### Device Programming

- **Device communication.** Use only the designated programmer and software application to communicate with this pulse generator.
- **STAT PACE settings.** When a pulse generator is programmed to STAT PACE settings, it will continue to pace at the high-energy STAT PACE values if it is not reprogrammed. The use of STAT PACE parameters will likely decrease device longevity.
- **Biventricular pacing therapy.** Programming the device to provide RV-only pacing is not intended for the treatment of heart failure. The clinical effects of RV-only pacing for the treatment of heart failure have not been established.
- **Pacing and sensing margins.** Consider lead maturation in your choice of Pacing Amplitude, pacing Pulse Width, and Sensitivity settings.

- An acute Pacing Threshold greater than 1.5 V or a chronic Pacing Threshold greater than 3 V can result in loss of capture because thresholds may increase over time.
- An R-Wave Amplitude less than 5 mV or a P-Wave Amplitude less than 2 mV can result in undersensing because the sensed amplitude may decrease after implantation.
- Pacing Lead Impedance should be greater than the programmed Low Impedance Limit and less than the programmed High Impedance Limit.
- **Lead impedance values and Lead Safety Switch.** If properly functioning leads with stable measured impedance values near the programmed impedance limits are used, consider programming Lead Safety Switch Off or changing the impedance limits to avoid undesirable switching to a Unipolar Lead Configuration.
- **Proper programming of the lead configuration.** If the Lead Configuration is programmed to Bipolar when a unipolar lead is implanted, pacing will not occur.
- **Programming for supraventricular tachyarrhythmias (SVTs).** Determine if the device and programmable options are appropriate for patients with SVTs because SVTs can initiate unwanted device therapy.
- **AV Delay.** To ensure a high percentage of biventricular pacing, the programmed AV Delay setting must be less than the patient's intrinsic PR interval.
- **Adaptive-rate pacing.** Rate Adaptive Pacing should be used with care in patients who are unable to tolerate increased pacing rates.
- **Ventricular refractory periods (VRPs) in adaptive-rate pacing.** Adaptive-rate pacing is not limited by refractory periods. A long refractory period programmed in combination with a high MSR can result in asynchronous pacing during refractory periods since the combination can cause a very small sensing window or none at all. Use Dynamic AV Delay or Dynamic PVARP to optimize sensing windows. If you are programming a fixed AV Delay, consider the sensing outcomes.

- **MTR/MSR programming.** The pulse generator's MTR and MSR should be programmed to a rate lower than a concomitant S-ICD's lowest tachycardia detection zone.
- **Atrial Tachy Response (ATR).** ATR should be programmed to On if the patient has a history of atrial tachyarrhythmias. The delivery of CRT is compromised because AV synchrony is disrupted if the ATR mode switch occurs.
- **Threshold test.** During a manual LV Threshold test, RV Backup Pacing is unavailable.
- **Left ventricular pacing only.** The clinical effect of LV pacing alone for heart failure patients has not been studied.
- **Atrial oversensing.** Take care to ensure that artifacts from the ventricles are not present on the atrial channel, or atrial oversensing may result. If ventricular artifacts are present in the atrial channel, the atrial lead may need to be repositioned to minimize its interaction.
- **ATR entry count.** Exercise care when programming the Entry Count to low values in conjunction with a short ATR Duration. This combination allows mode switching with very few fast atrial beats. For example, if the Entry Count was programmed to 2 and the ATR Duration to 0, ATR mode switching could occur on 2 fast atrial intervals. In these instances, a short series of premature atrial events could cause the device to mode switch.
- **ATR exit count.** Exercise care when programming the Exit Count to low values. For example, if the Exit Count was programmed to 2, a few cycles of atrial undersensing could cause termination of mode switching.
- **Proper programming without an atrial lead.** If an atrial lead is not implanted (port is plugged instead), or an atrial lead is abandoned but remains connected to the header, device programming should be consistent with the number and type of leads actually in use.
- **Atrial sensing programmed to Off.** When atrial sensing is programmed to Off in a DDI(R) or DDD(R) mode, any atrial pacing that occurs will be asynchronous. Additionally, features that require atrial sensing may not function as expected.

- **High atrial rates.** Sensing high atrial rates may impact device longevity. Therefore, the Atrial Sense lead configuration will be seeded to Off when programming from an atrial sensing mode to a non-atrial sensing mode.
- **Cross-chamber artifacts.** Sensitivity adjustments associated with Smart Blanking may not be sufficient to inhibit detection of cross-chamber artifacts if the cross-chamber artifacts are too large. Consider other factors that impact the size/amplitude of cross-chamber artifacts including lead-placement, pacing output, and programmed Sensitivity settings.
- **Signal Artifact Monitor Programming Considerations.** For maximum sensitivity in detecting and preventing potential signal artifact-generated oversensing, it is recommended that the Signal Artifact Monitor (SAM) is programmed On any time the MV/Respiratory Sensor is programmed to On or Passive. Turning the Signal Artifact Monitor Off may put the patient at increased risk of oversensing, unless the MV/Respiratory Sensor is also programmed Off.
- **Turning the Signal Artifact Monitor Off.** Turning the Signal Artifact Monitor Off may put the patient at increased risk of oversensing; unless the MV/Respiratory Sensor is also programmed to Off.
- **Single pass VDD leads.** When a single pass VDD lead is used with a dual-chamber device, the atrial electrodes may not be in contact with the atrial wall. In this case, the measured depolarization signal has a relatively low Amplitude and could require a more sensitive setting.
- **Left ventricular lead configuration.** Proper programming of the LV coronary venous Lead Configuration is essential for proper LV lead function. Program the Lead Configuration in accordance with the number of electrodes on the LV lead; otherwise, erratic LV sensing, loss of LV pacing, or ineffective LV pacing might occur.
- **Quadripolar pacing configuration.** When an LVRing4>>RV pacing configuration is programmed with an IS4-LLLL lead, the LV tip may be used as the anode rather than the RV ring. When programming to this configuration, evaluate the pacing threshold and ensure no extracardiac stimulation is present.

- **Left Ventricular Protection Period (LVPP).** Use of a long LVPP reduces the maximum LV pacing rate and may inhibit CRT at higher pacing rates.
- **MV Recalibration.** To obtain an accurate MV baseline following any surgical procedure involving the pulse generator or leads, a new, manual calibration should be performed. Lead maturation, air entrapment in the pocket, pulse generator motion due to inadequate suturing, external defibrillation or cardioversion, or other patient complications (e.g., pneumothorax) require a new MV baseline for appropriate MV behavior.
- **Sensing adjustment.** Following any Sensitivity parameter adjustment or any modification of the sensing lead, always verify appropriate sensing. Programming Sensitivity to the highest value (lowest sensitivity) may result in undersensing of cardiac activity. Likewise, programming to the lowest value (highest sensitivity) may result in oversensing of non-cardiac signals.
- **Sensitivity in unipolar lead configuration.** The amplitude and prevalence of myopotential noise is increased in unipolar lead configurations, as compared to bipolar lead configurations. For patients with a unipolar lead configuration and myopotential oversensing during activity involving the pectoral muscles, the programming of Fixed Sensitivity is recommended.
- **Use of Patient Triggered Monitor.** Use care when using Patient Triggered Monitor, because the following conditions will exist while it is enabled:
  - All other magnet features, including asynchronous pacing, are disabled. The Magnet feature will not indicate magnet position.
  - Device longevity is impacted. To help reduce the longevity impact, PTM only allows storage of one episode, and PTM is automatically disabled after 60 days if data storage was never triggered.
  - Once the EGM is stored (or 60 days elapses), PTM is disabled and the device Magnet Response automatically will be set to Pace Async. However, if a magnet is used, the pulse generator will not revert to asynchronous operation until the magnet is removed for 3 seconds and placed on the device again.

## Environmental and Medical Therapy Hazards

- **Avoid electromagnetic interference (EMI).** Advise patients to avoid sources of EMI. The pulse generator may inhibit pacing due to oversensing, or may switch to asynchronous pacing at the programmed pacing rate or at the magnet rate in the presence of EMI.

Moving away from the source of the EMI or turning off the source usually allows the pulse generator to return to normal operation.

Examples of potential EMI sources are:

- Electrical power sources, arc welding or resistance welding equipment, and robotic jacks
- High voltage power distribution lines
- Electrical smelting furnaces
- Large RF transmitters such as radar
- Radio transmitters, including those used to control toys
- Electronic surveillance (antitheft) devices
- An alternator on a car that is running
- Medical treatments and diagnostic tests in which an electrical current is passed through the body, such as TENS, electrocautery, electrolysis/thermolysis, electrodiagnostic testing, electromyography, or nerve conduction studies
- Any externally applied device that uses an automatic lead detection alarm system (e.g., an EKG machine)

## Hospital and Medical Environments

- **Mechanical ventilators.** Program the MV/Respiratory Sensor to Off during mechanical ventilation. Otherwise, the following may occur:

- Inappropriate MV Sensor-driven rate
- Misleading respiration-based trending
- **Conducted electrical current.** Any medical equipment, treatment, therapy, or diagnostic test that introduces electrical current into the patient has the potential to interfere with pulse generator function.
  - External patient monitors (e.g., respiratory monitors, surface ECG monitors, hemodynamic monitors) may cause:
    - Inappropriate MV Sensor-driven rate (up to maximum sensor-driven rate)
    - Misleading respiration-based trending
  - Medical therapies, treatments, and diagnostic tests that use conducted electrical current (e.g., TENS, electrocautery, electrolysis/thermolysis, electrodiagnostic testing, electromyography, or nerve conduction studies) may interfere with or damage the pulse generator. Program the device to Electrocautery Protection Mode prior to the treatment, and monitor device performance during the treatment. After the treatment, verify pulse generator function ("Post-Therapy Pulse Generator Follow Up" on page 23).

To resolve suspected interactions with MV rate driving and/or MV/Respiratory Sensor-based diagnostics, deactivate the MV/Respiratory Sensor by programming it to Off. If a PRM is not available and the pulse generator is pacing at the sensor-driven rate, apply a magnet to the pulse generator to initiate temporary asynchronous, non-rate responsive pacing.

- **Internal defibrillation.** Do not use internal defibrillation paddles or catheters unless the pulse generator is disconnected from the leads because the leads may shunt energy. This could result in injury to the patient and damage to the implanted system.
- **External defibrillation.** It can take up to 15 seconds for sensing to recover after an external shock is delivered. In non-emergency situations, for pacemaker dependent patients, consider programming the

pulse generator to an asynchronous pacing mode and programming the MV/Respiratory Sensor to Off prior to performing external cardioversion or defibrillation.

External defibrillation or cardioversion can damage the pulse generator. To help prevent damage to the pulse generator, consider the following:

- Avoid placing a pad (or paddle) directly over the pulse generator. Position the pads (or paddles) as far from the pulse generator as possible.
- Position the pads (or paddles) in a posterior-anterior orientation when the device is implanted in the right pectoral region or an anterior-apex orientation when the device is implanted in the left pectoral region.
- Set energy output of external defibrillation equipment as low as clinically acceptable.

Following external cardioversion or defibrillation, verify pulse generator function ("Post-Therapy Pulse Generator Follow Up" on page 23).

- **Lithotripsy.** Extracorporeal shock wave lithotripsy (ESWL) may cause electromagnetic interference with or damage to the pulse generator. If ESWL is medically necessary, consider the following to minimize the potential for encountering interaction:
  - Focus the ESWL beam at least 15 cm (6 in) away from the pulse generator.
  - Depending on the pacing needs of the patient, program the Brady Mode to a non-rate-responsive VVI or VOO mode.
- **Ultrasound energy.** Therapeutic ultrasound (e.g., lithotripsy) energy may damage the pulse generator. If therapeutic ultrasound energy must be used, avoid focusing near the pulse generator site. Diagnostic ultrasound (e.g., echocardiography) is not known to be harmful to the pulse generator.
- **Electrical interference.** Electrical interference or "noise" from devices such as electrocautery and monitoring equipment may interfere with establishing or maintaining telemetry for interrogating or programming the device. In the presence of such interference, move the programmer away from electrical



devices, and ensure that the wand cord and cables are not crossing one another. If telemetry is cancelled as a result of interference, the device should be re-interrogated prior to evaluating information from pulse generator memory.

- **Radio frequency (RF) interference.** RF signals from devices that operate at frequencies near that of the pulse generator may interrupt ZIP telemetry while interrogating or programming the pulse generator. This RF interference can be reduced by increasing the distance between the interfering device and the PRM and pulse generator. Examples of devices that may cause interference in the 869.85 MHz frequency band include:
  - Cordless phone handsets or base stations
  - Certain patient monitoring systems
- **Central line guidewire insertion.** Use caution when inserting guidewires for placement of other types of central venous catheter systems such as PIC lines or Hickman catheters in locations where pulse generator leads may be encountered. Insertion of such guidewires into veins containing leads could result in the leads being damaged or dislodged.

### Home and Occupational Environments

- **Home appliances.** Home appliances that are in good working order and properly grounded do not usually produce enough EMI to interfere with pulse generator operation. There have been reports of pulse generator disturbances caused by electric hand tools or electric razors used directly over the pulse generator implant site.
- **Magnetic fields.** Advise patients that extended exposure to strong (greater than 10 gauss or 1 mTesla) magnetic fields may trigger the magnet feature. Examples of magnetic sources include:
  - Industrial transformers and motors
  - MRI scanners

**NOTE:** The magnet feature is disabled when the device is in MRI Protection Mode. Refer to "Magnetic Resonance Imaging (MRI)" on page 24 and the MRI Technical Guide for more information.

- Large stereo speakers
- Telephone receivers if held within 1.27 cm (0.5 inches) of the pulse generator
- Magnetic wands such as those used for airport security and in the Bingo game
- **Electronic Article Surveillance (EAS) and security systems.** Advise patients how to avoid impact to cardiac device function due to antitheft and security gates, tag deactivators, or tag readers that include radio frequency identification (RFID) equipment. These systems may be found at the entrances and exits of stores, at checkout counters, in public libraries, and in point-of-entry access control systems. Patients should avoid lingering near or leaning against antitheft and security gates and tag readers. In addition, patients should avoid leaning against checkout counter-mounted and handheld tag deactivation systems. Anti-theft gates, security gates, and entry control systems are unlikely to affect cardiac device function when patients walk through them at a normal pace. If the patient is near an electronic antitheft, security, or entry control system and experiences symptoms, they should promptly move away from nearby equipment and inform their doctor.
- **Cellular phones.** Advise patients to hold cellular phones to the ear opposite the side of the implanted device. Patients should not carry a cellular phone that is turned on in a breast pocket or on a belt within 15 cm (6 inches) of the implanted device since some cellular phones may cause the pulse generator to deliver inappropriate therapy or inhibit appropriate therapy.

#### Follow-up Testing

- **Pacing threshold testing.** If the patient's condition or drug regimen has changed or device parameters have been reprogrammed, consider performing a pacing threshold test to confirm adequate margins for pace capture.
- **Follow-up considerations for patients leaving the country.** Pulse generator follow-up considerations should be made in advance for patients who plan to travel or relocate post-implant to a country other than

the country in which their device was implanted. Regulatory approval status for devices and associated programmer software configurations varies by country; certain countries may not have approval or capability to follow specific products.

Contact Boston Scientific, using the information on the back cover, for help in determining feasibility of device follow-up in the patient's destination country.

### Explant and Disposal

- **Incineration.** Be sure that the pulse generator is removed before cremation. Cremation and incineration temperatures might cause the pulse generator to explode.
- **Device handling.** Before explanting, cleaning, or shipping the device, complete the following actions to prevent overwriting of important therapy history data:
  - Program the pulse generator Brady Mode to Off
  - Program Ventricular Tachy EGM Storage to Off

Clean and disinfect the device using standard biohazard handling techniques.

### SUPPLEMENTAL PRECAUTIONARY INFORMATION

#### Post-Therapy Pulse Generator Follow Up

Following any surgery or medical procedure with the potential to affect pulse generator function, you should perform a thorough follow-up, which may include the following:

- Interrogating the pulse generator with a programmer
- Reviewing clinical events and fault codes
- Reviewing the Arrhythmia Logbook, including stored electrograms (EGMs)
- Reviewing real-time EGMs
- Testing the leads (threshold, amplitude, and impedance)

- Reviewing MV Sensor-based diagnostics, MV Sensor performance, and performing a manual MV Sensor calibration if desired
- Reviewing Respiratory Sensor-based diagnostics
- Verifying battery status
- Programming any permanent brady parameter to a new value and then reprogramming it back to the desired value
- Saving all patient data
- Verifying the appropriate final programming prior to allowing the patient to leave the clinic

### **Magnetic Resonance Imaging (MRI)**

The following Warnings and Precautions, and Conditions of Use are applicable to MRI scanning of patients implanted with an ImageReady MR Conditional Pacing System. Refer to the MRI Technical Guide at [www.bostonscientific-elabeling.com](http://www.bostonscientific-elabeling.com) for a comprehensive list of Warnings and Precautions, and Conditions of Use that are applicable to MRI scanning of patients implanted with an ImageReady MR Conditional Pacing System.

### **MR Conditional Pacing System Warnings and Precautions**

**WARNING:** VISIONIST X4 and VALITUDE X4 devices are considered MR Conditional. For these devices, unless all of the MRI Conditions of Use are met, MRI scanning of the patient does not meet MR Conditional requirements for the implanted system. Significant harm to or death of the patient and/or damage to the implanted system may result. *All other devices covered by this manual are not MR conditional.* Do not expose patients with non-MR Conditional devices to MRI scanning. Strong magnetic fields may damage the pulse generator and/or lead system, possibly resulting in injury to or death of the patient.

For potential adverse events applicable when the Conditions of Use are met or not met, refer to the MRI Technical Guide. For additional warnings, precautions, and Conditions of Use, refer to "Magnetic Resonance Imaging (MRI)" on page 24.

**WARNING:** Ensure the selected/implanted ImageReady Pacing System components constitute an appropriate combination for MR Conditional status and that the Conditions of Use can be met. Combinations of components other than those specified in the MRI Technical Guide have not been evaluated for use in an MRI environment. Refer to the MRI Technical Guide for details.

**WARNING:** MRI scanning after Explant status has been reached may lead to premature battery depletion, a shortened device replacement window, or sudden loss of pacing. After performing an MRI scan on a device that has reached Explant status, verify pulse generator function ("Post-Therapy Pulse Generator Follow Up" on page 23) and schedule device replacement.

**WARNING:** During MRI Protection Mode, if Brady Mode is programmed to Off, Bradycardia therapy and Cardiac Resynchronization Therapy (CRT) are suspended. The patient will not receive pacing until the pulse generator is programmed back to normal operation. Only program Brady Mode to Off during MRI Protection Mode if the patient is judged to be clinically capable of tolerating no Bradycardia therapy (including pacing-dependence or need for overdrive pacing) and no CRT for the entire duration in which the pulse generator is in MRI Protection Mode.

**WARNING:** If the pulse generator enters Safety Mode from MRI Protection Mode, backup pacing will not occur in the following scenarios:

- if a functional bipolar right ventricular pacing lead is not present
- if the Pacing Mode under MRI Protection Mode settings is programmed to Off; the pulse generator will continue permanently with the Pacing Mode programmed to Off, and the patient will not receive pacing therapy until the pulse generator is replaced

**WARNING:** The Programmer is MR Unsafe and must remain outside the MRI site Zone III (and higher) as defined by the American College of Radiology Guidance Document for Safe MR Practices<sup>3</sup>. Under no circumstances should the Programmer be brought into the MRI scanner room, the control room, or the MRI site Zone III or IV areas.

---

3. Kanal E, et al., American Journal of Roentgenology 188:1447-74, 2007.

**WARNING:** Implant of the system cannot be performed in an MRI site Zone III (and higher) as defined by the American College of Radiology Guidance Document for Safe MR Practices<sup>4</sup>. Some of the accessories packaged with pulse generators and leads, including the torque wrench and stylet wires, are not MR Conditional and should not be brought into the MRI scanner room, the control room, or the MRI site Zone III or IV areas.

**CAUTION:** The physician choosing MRI Protection Mode parameter values will need to exercise professional judgment to determine an individual patient's ability to tolerate the pacing parameters required for MR Conditional scanning, in conjunction with the physical conditions required during a scan (for example, prolonged time in a supine position).

**CAUTION:** If the MR Conditional Pacing System enters Safety Core Operation during MRI Protection Mode and the pacing mode was set to a value other than Off, MRI Protection Mode pacing will be automatically switched to VOO mode, pacing chamber RV only, RV bipolar configuration (sensing and pacing), 5.0 V pace pulse amplitude, 1.0 ms pulse width, and 72.5 min<sup>-1</sup> pacing rate as the safety mode.

**NOTE:** *Other implanted devices or patient conditions may still cause a patient to be ineligible for an MRI scan, independent of the status of the patient's ImageReady MR Conditional Pacing System.*

### **MRI Conditions of Use**

The following Conditions of Use must be met in order for a patient with an ImageReady Pacing System to undergo an MRI scan. Adherence to the Conditions of Use must be verified prior to each scan to ensure that the most up to date information has been used to assess the patient's eligibility and readiness for an MR Conditional scan. Refer to the MRI Technical Guide at [www.bostonscientific-elabeling.com](http://www.bostonscientific-elabeling.com) for a comprehensive list of Warnings and Precautions, and Conditions of Use that are applicable to MRI scanning of patients implanted with an ImageReady MR Conditional Pacing System.

#### **Cardiology**

1. Patient is implanted with an ImageReady MR Conditional Pacing System

---

4. Kanal E, et al., American Journal of Roentgenology 188:1447-74, 2007.

2. RA and RV leads programmed to bipolar pacing operation or pacing off
3. Pulse generator implant location restricted to left or right pectoral region
4. At least six (6) weeks have elapsed since implantation and/or any lead revision or surgical modification of the MR Conditional Pacing System
5. No other active or abandoned implanted devices, components, or accessories present, such as lead adaptors, extenders, leads, or pulse generators
6. RA and RV pacing threshold  $\leq 2.0$  V in paced leads for pace-dependent patients
7. No evidence of a fractured lead or compromised pulse generator-lead system integrity

### **Minimizing Pacemaker/S-ICD Interaction**

These pulse generators are compatible for use with a Subcutaneous Implantable Cardioverter Defibrillator (S-ICD) when implanted with bipolar leads and programmed to a bipolar pacing configuration.

A pacemaker can interact with an S-ICD in the following ways:

- If during a tachyarrhythmia the pacemaker is not inhibited and the pacing pulses are detected by the rate-sensing circuit of the S-ICD, the S-ICD could interpret the pacing pulses as a normal rhythm. The S-ICD would not detect the arrhythmia and therefore would not deliver therapy.
- Pacemaker failure to sense or to capture could result in two independent signals (intrinsic and pacing pulses) to the S-ICD. This could cause the S-ICD's rate measurement to be faster than the actual heart rate. As a result, the S-ICD could deliver unnecessary therapy.
- If the S-ICD counts both the pacing pulses and the resultant ventricular depolarizations, the S-ICD's rate measurement would be faster than the actual heart rate. This could result in unnecessary S-ICD therapy.

In Safety Mode, these pulse generators use a unipolar pacing and sensing configuration. Safety Mode is compatible for use with an S-ICD because the configured parameters mitigate the potential pacemaker and S-ICD interactions as follows:

- Sensing is AGC at 0.25 mV. The AGC sensing is able to effectively sense an intrinsic rhythm faster than the Safety Mode LRL of 72.5 min<sup>-1</sup>. As a result, pacing is inhibited and does not interfere with S-ICD tachyarrhythmia detection.
- When pacing is necessary, the elevated output of 5.0 V and 1.0 ms reduces the risk of not capturing.
- If double detection of the pace pulse and the resulting depolarization were to occur, it would not result in unnecessary S-ICD therapy provided the S-ICD tachy threshold is more than twice the Safety Mode LRL (145 min<sup>-1</sup>).

To help minimize device-device interaction of a bipolar pacemaker when an S-ICD is already implanted, follow these precautionary measures:

- Use bipolar pacing leads with close electrode spacing in both chambers. Significant spacing between electrodes may increase the likelihood that the S-ICD will detect the pacing pulses.
- Consider programming the pacemaker to (1) the lowest Amplitude allowable for safe capture in the chronic state, (2) the maximum Sensitivity (the lowest programmable level) while maintaining an adequate safety margin, and (3) the minimum cardiac rate acceptable for the patient.

In addition to the above steps, perform the following testing to assess device-device interaction:

- Use the S-ICD features, such as markers, real-time electrograms (EGMs), and/or beeping tones, to help evaluate potential for pacemaker interaction due to oversensing by the S-ICD.

**NOTE:** *If a single chamber pacemaker is implanted with an atrial lead, perform testing in both unipolar and bipolar configurations.*

- Ventricular fibrillation and all of the patient's ventricular tachycardias should be induced while the S-ICD is activated and the pacemaker is programmed to an asynchronous mode at maximum Amplitude and Pulse



Width. This should provide the greatest opportunity for inhibition of arrhythmia detection due to detection of pacemaker pacing pulses. The pacemaker leads might have to be repositioned to eliminate detection of the pacing pulses by the S-ICD.

Temporarily deactivate the patient's S-ICD when (1) evaluating pacing and sensing thresholds, (2) when using an external temporary pacemaker during implant, and (3) when reprogramming an implanted pacemaker.

Following any S-ICD discharge, reinterrogate the pacemaker to ensure that the S-ICD shock did not damage the pacemaker.

If implanting an S-ICD in a patient who has a pacemaker already implanted, refer to the S-ICD manual for implantation considerations.

Refer to the Warnings section for additional information regarding pacemaker and S-ICD interactions.

### **Transcutaneous Electrical Nerve Stimulation (TENS)**

**CAUTION:** TENS involves passing electrical current through the body, and may interfere with pulse generator function. If TENS is medically necessary, evaluate the TENS therapy settings for compatibility with the pulse generator. The following guidelines may reduce the likelihood of interaction:

- Place the TENS electrodes as close together and as far away from the pulse generator and leads as possible.
- Use the lowest clinically-appropriate TENS energy output.
- Consider cardiac monitoring during TENS use, especially for pacemaker-dependent patients.

Additional steps can be taken to help reduce interference during in-clinic use of TENS:

- If interference is suspected during in-clinic use, turn off the TENS unit.
- If pacing inhibition is observed, use a magnet to pace asynchronously.

- Do not change TENS settings until you have verified that the new settings do not interfere with pulse generator function.

If TENS is medically necessary outside the clinical setting (at-home use), provide patients with the following instructions:

- Do not change the TENS settings or electrode positions unless instructed to do so.
- End each TENS session by turning off the unit before removing the electrodes.
- If the patient experiences symptoms of lightheadedness, dizziness, or loss of consciousness during TENS use, they should turn off the TENS unit and contact their physician.

Follow these steps to use the PRM to evaluate pulse generator function during TENS use:

1. Observe real-time EGMs at prescribed TENS output settings, noting when appropriate sensing or interference occurs.

**NOTE:** *Patient triggered monitoring may be used as an additional method to confirm device function during TENS use.*

2. When finished, turn off the TENS unit.

You should also perform a thorough follow-up evaluation of the pulse generator following TENS, to ensure that device function has not been compromised ("Post-Therapy Pulse Generator Follow Up" on page 23).

For additional information, contact Boston Scientific using the information on the back cover.

### **Electrocautery and Radio Frequency (RF) Ablation**

**CAUTION:** Electrocautery and RF ablation may induce ventricular arrhythmias and/or fibrillation, and may cause asynchronous pacing, inhibition of pacing, and/or a reduction in pulse generator pacing output possibly leading to loss of capture. RF ablation may also cause ventricular pacing up to the MTR and/or changes in

pacing thresholds. Additionally, exercise caution when performing any other type of cardiac ablation procedure in patients with implanted devices.

If electrocautery or RF ablation is medically necessary, observe the following to minimize risk to the patient and device:

- Depending on the pacing needs of the patient, enable the Electrocautery Protection Mode, program to an asynchronous pacing mode, or use a magnet to switch to asynchronous pacing. An option for patients with intrinsic rhythm is to program the Brady Mode to VVI at a rate below the intrinsic rate to avoid competitive pacing.
- Have temporary pacing and external defibrillation equipment available.
- Avoid direct contact between the electrocautery equipment or ablation catheters and the pulse generator and leads. RF ablation close to the lead electrode may damage the lead-tissue interface.
- Keep the path of the electrical current as far away as possible from the pulse generator and leads.
- If RF ablation and/or electrocautery is performed on tissue near the device or leads, monitor pre- and post-measurements for sensing and pacing thresholds and impedances to determine the integrity and stability of the system.
- For electrocautery, use a bipolar electrocautery system where possible and use short, intermittent, and irregular bursts at the lowest feasible energy levels.
- RF ablation equipment may cause telemetry interference between the pulse generator and PRM. If device programming changes are necessary during an RF ablation procedure, turn off the RF ablation equipment before interrogation.

When the procedure is finished, cancel the Electrocautery Protection Mode in order to reactivate the previously programmed therapy modes.

## Ionizing Radiation

**CAUTION:** It is not possible to specify a safe radiation dosage or guarantee proper pulse generator function following exposure to ionizing radiation. Multiple factors collectively determine the impact of radiation therapy on an implanted pulse generator, including proximity of the pulse generator to the radiation beam, type and energy level of the radiation beam, dose rate, total dose delivered over the life of the pulse generator, and shielding of the pulse generator. The impact of ionizing radiation will also vary from one pulse generator to another and may range from no changes in function to a loss of pacing.

Sources of ionizing radiation vary significantly in their potential impact on an implanted pulse generator. Several therapeutic radiation sources are capable of interfering with or damaging an implanted pulse generator, including those used for the treatment of cancer, such as radioactive cobalt, linear accelerators, radioactive seeds, and betatrons.

Prior to a course of therapeutic radiation treatment, the patient's radiation oncologist and cardiologist or electrophysiologist should consider all patient management options, including increased follow-up and device replacement. Other considerations include:

- Maximizing shielding of the pulse generator within the treatment field
- Determining the appropriate level of patient monitoring during treatment

Evaluate pulse generator operation during and following the course of radiation treatment to exercise as much device functionality as possible ("Post-Therapy Pulse Generator Follow Up" on page 23). The extent, timing, and frequency of this evaluation relative to the radiation therapy regimen are dependent upon current patient health, and therefore should be determined by the attending cardiologist or electrophysiologist.

Many pulse generator diagnostics are performed automatically once per hour, so pulse generator evaluation should not be concluded until pulse generator diagnostics have been updated and reviewed (at least one hour after radiation exposure). The effects of radiation exposure on the implanted pulse generator may remain undetected until some time following exposure. For this reason, continue to monitor pulse generator function closely and use caution when programming a feature in the weeks or months following radiation therapy.

## Elevated Pressures

The International Standards Organization (ISO) has not approved a standardized pressure test for implantable pulse generators that experience hyperbaric oxygen therapy (HBOT) or SCUBA diving. However, Boston Scientific developed a test protocol to evaluate device performance upon exposure to elevated atmospheric pressures. The following summary of pressure testing should not be viewed as and is not an endorsement of HBOT or SCUBA diving.

**CAUTION:** Elevated pressures due to HBOT or SCUBA diving may damage the pulse generator. During laboratory testing, all pulse generators in the test sample functioned as designed when exposed to more than 1000 cycles at a pressure up to 5.0 ATA. Laboratory testing did not characterize the impact of elevated pressure on pulse generator performance or physiological response while implanted in a human body.

Pressure for each test cycle began at ambient/room pressure, increased to a high pressure level, and then returned to ambient pressure. Although dwell time (the amount of time under elevated pressure) may have an impact on human physiology, testing indicated it did not impact pulse generator performance. Pressure value equivalencies are provided below (Table 1 Pressure Value Equivalencies on page 33).

**Table 1. Pressure Value Equivalencies**

| Pressure value equivalencies |               |
|------------------------------|---------------|
| Atmospheres Absolute         | 5.0 ATA       |
| Sea water depth <sup>a</sup> | 40 m (130 ft) |
| Pressure, absolute           | 72.8 psia     |
| Pressure, gauge <sup>b</sup> | 58.1 psig     |

**Table 1. Pressure Value Equivalencies (continued)**

| Pressure value equivalencies |     |
|------------------------------|-----|
| Bar                          | 5.0 |
| kPa Absolute                 | 500 |

- All pressures were derived assuming sea water density of 1030 kg/m<sup>3</sup>.
- Pressure as read on a gauge or dial (psia = psig + 14.7 psi).

Prior to SCUBA diving or starting an HBOT program, the patient's attending cardiologist or electrophysiologist should be consulted to fully understand the potential consequences relative to the patient's specific health condition. A Dive Medicine Specialist may also be consulted prior to SCUBA diving.

More frequent device follow-up may be warranted in conjunction with HBOT or SCUBA diving. Evaluate pulse generator operation following high pressure exposure ("Post-Therapy Pulse Generator Follow Up" on page 23). The extent, timing, and frequency of this evaluation relative to the high pressure exposure are dependent upon current patient health, and should be determined by the attending cardiologist or electrophysiologist.

If you have additional questions, or would like more detail regarding the test protocol or test results specific to HBOT or SCUBA diving, contact Boston Scientific using the information on the back cover.

### POTENTIAL ADVERSE EVENTS

Based on the literature and on pulse generator and/or lead implant experience, the following list includes the possible adverse events associated with implantation of products described in this literature:

- Air embolism
- Allergic reaction
- Bleeding

- Bradycardia
- Cardiac tamponade
- Chronic nerve damage
- Component failure
- Conductor coil fracture
- Death
- Electrolyte imbalance/dehydration
- Elevated thresholds
- Erosion
- Excessive fibrotic tissue growth
- Extracardiac stimulation (muscle/nerve stimulation)
- Fluid accumulation
- Foreign body rejection phenomena
- Formation of hematomas or seromas
- Heart block
- Inability to pace
- Inappropriate pacing
- Incisional pain
- Incomplete lead connection with pulse generator
- Infection including endocarditis
- Lead dislodgment
- Lead fracture
- Lead insulation breakage or abrasion

- Lead perforation
- Lead tip deformation and/or breakage
- Local tissue reaction
- Loss of capture
- Myocardial infarction (MI)
- Myocardial necrosis
- Myocardial trauma (e.g., tissue damage, valve damage)
- Myopotential sensing
- Oversensing/undersensing
- Pacemaker-mediated tachycardia (PMT)
- Pericardial rub, effusion
- Pneumothorax
- Pulse generator migration
- Shunting current during defibrillation with internal or external paddles
- Syncope
- Tachyarrhythmias, which include acceleration of arrhythmias and early, recurrent atrial fibrillation
- Thrombosis/thromboemboli
- Valve damage
- Vasovagal response
- Venous occlusion
- Venous trauma (e.g., perforation, dissection, erosion)
- Worsening heart failure

For a list of potential adverse events associated with MRI scanning, refer to the MRI Technical Guide.



Patients may develop psychological intolerance to a pulse generator system and may experience the following:

- Dependency
- Depression
- Fear of premature battery depletion
- Fear of device malfunction

Additionally, potential adverse events associated with the implantation of a coronary venous lead system include:

- Allergic reaction to contrast media
- Breakage/failure of implant instruments
- Prolonged exposure to fluoroscopic radiation
- Renal failure from contrast media used to visualize coronary veins

## **MECHANICAL SPECIFICATIONS**

**The following mechanical specifications and material specifications apply to VISIONIST and VALITUDE devices.**

All VISIONIST and VALITUDE models have a case electrode surface area of 35.05 cm<sup>2</sup> and all VISIONIST X4 and VALITUDE X4 models have a case electrode surface area of 34.58 cm<sup>2</sup>. Usable battery capacity is 1.6 Ah and residual usable battery capacity at Explant is 0.10 Ah.

Mechanical specifications specific to each model are listed below.

**Table 2. Mechanical Specifications - VISIONIST CRT-Ps**

| <b>Model</b>     | <b>Dimensions<br/>W x H x D (cm)</b> | <b>Mass (g)</b> | <b>Volume (cm<sup>3</sup>)</b> | <b>Connector Type</b>           |
|------------------|--------------------------------------|-----------------|--------------------------------|---------------------------------|
| U225             | 4.45 x 6.13 x 0.75                   | 30.6            | 15.2                           | RA: IS-1; RV: IS-1;<br>LV: IS-1 |
| U226             | 4.45 x 6.13 x 0.75                   | 31.1            | 15.2                           | RA: IS-1; RV: IS-1;<br>LV: LV-1 |
| <b>MRI Model</b> |                                      |                 |                                |                                 |
| U228             | 4.45 x 6.17 x 0.75                   | 33.0            | 16.6                           | RA: IS-1; RV: IS-1;<br>LV: IS4  |

**Table 3. Mechanical Specifications - VALITUDE CRT-Ps**

| <b>Model</b>     | <b>Dimensions<br/>W x H x D (cm)</b> | <b>Mass (g)</b> | <b>Volume (cm<sup>3</sup>)</b> | <b>Connector Type</b>           |
|------------------|--------------------------------------|-----------------|--------------------------------|---------------------------------|
| U125             | 4.45 x 6.13 x 0.75                   | 30.6            | 15.2                           | RA: IS-1; RV: IS-1;<br>LV: IS-1 |
| <b>MRI Model</b> |                                      |                 |                                |                                 |
| U128             | 4.45 x 6.17 x 0.75                   | 33.0            | 16.6                           | RA: IS-1; RV: IS-1;<br>LV: IS4  |

VISIONIST and VALITUDE devices include ZIP telemetry operating with a transmit frequency of 402 to 405 MHz.

Material specifications are shown below:

- Case: hermetically sealed titanium
- Header: implantation-grade polymer
- Power Supply (VISIONIST and VALITUDE): lithium-carbon monofluoride cell; Boston Scientific; 402294

**The following mechanical specifications and material specifications apply to INLIVEN, INTUA, and INVIVE devices.**

All INLIVEN, INTUA, and INVIVE models have a case electrode surface area of 35.98 cm<sup>2</sup>. Usable battery capacity is 1.45 Ah and residual usable battery capacity at Explant is 0.09 Ah.

Mechanical specifications specific to each model are listed below.

**Table 4. Mechanical Specifications - INLIVEN CRT-Ps**

| Model | Dimensions<br>W x H x D (cm) | Mass (g) | Volume (cm <sup>3</sup> ) | Connector Type                  |
|-------|------------------------------|----------|---------------------------|---------------------------------|
| W274  | 4.45 x 6.10 x 0.75           | 34.0     | 15.0                      | RA: IS-1, RV: IS-1,<br>LV: LV-1 |
| W275  | 4.45 x 6.10 x 0.75           | 34.0     | 15.0                      | RA: IS-1, RV: IS-1,<br>LV: IS-1 |

**Table 5. Mechanical Specifications - INTUA CRT-Ps**

| Model | Dimensions<br>W x H x D (cm) | Mass (g) | Volume (cm <sup>3</sup> ) | Connector Type                  |
|-------|------------------------------|----------|---------------------------|---------------------------------|
| W272  | 4.45 x 6.10 x 0.75           | 34.0     | 15.0                      | RA: IS-1, RV: IS-1,<br>LV: LV-1 |
| W273  | 4.45 x 6.10 x 0.75           | 34.0     | 15.0                      | RA: IS-1, RV: IS-1,<br>LV: IS-1 |

**Table 6. Mechanical Specifications - INVIVE CRT-Ps**

| Model | Dimensions<br>W x H x D (cm) | Mass (g) | Volume (cm <sup>3</sup> ) | Connector Type                  |
|-------|------------------------------|----------|---------------------------|---------------------------------|
| W172  | 4.45 x 6.10 x 0.75           | 34.0     | 15.0                      | RA: IS-1, RV: IS-1,<br>LV: LV-1 |
| W173  | 4.45 x 6.10 x 0.75           | 34.0     | 15.0                      | RA: IS-1, RV: IS-1,<br>LV: IS-1 |

INLIVEN, INTUA, and INVIVE devices include ZIP telemetry operating with a transmit frequency of 869.85 MHz.

Material specifications are shown below:

- Case: hermetically sealed titanium
- Header: implantation-grade polymer
- Power Supply (INLIVEN, INTUA, and INVIVE): lithium-manganese dioxide cell; Boston Scientific; 402125

## ITEMS INCLUDED IN PACKAGE

The following items are included with the pulse generator:

- One torque wrench
- Product literature

**NOTE:** *Accessories (e.g., wrenches) are intended for one-time use only. They should not be resterilized or reused.*

**WARNING:** Implant of the system cannot be performed in an MRI site Zone III (and higher) as defined by the American College of Radiology Guidance Document for Safe MR Practices<sup>5</sup>. Some of the accessories packaged with pulse generators and leads, including the torque wrench and stylet wires, are not MR Conditional and should not be brought into the MRI scanner room, the control room, or the MRI site Zone III or IV areas.







## SYMBOLS ON PACKAGING

The following symbols may be used on packaging and labeling (Table 7 Symbols on packaging on page 42):







---

5. Kanal E, et al., American Journal of Roentgenology 188:1447-74, 2007.





**Table 7. Symbols on packaging**

| Symbol   | Description         |
|--|---------------------|
|  | Reference number    |
|  | Package contents    |
|  | Pulse generator     |
|  | Torque wrench       |
|  | Literature enclosed |
|  | Serial number       |
|  | Use by              |

**Table 7. Symbols on packaging (continued)**







| Symbol  | Description                      |
|---|----------------------------------|
|  | Lot number                       |
|  | Date of manufacture              |
|  | Sterilized using ethylene oxide  |
|  | Do not resterilize               |
|  | Do not reuse                     |
|  | Do not use if package is damaged |

**Table 7. Symbols on packaging (continued)**





| Symbol  | Description   |
|---|---|
|  <p>The logo for Boston Scientific e-labeling, featuring an open book with an information icon (i) inside, surrounded by the text 'www.bostonscientific-elabeling.com' in a circular arrangement.</p> | <p>Consult instructions for use on this website: <a href="http://www.bostonscientific-elabeling.com">www.bostonscientific-elabeling.com</a></p> |
|  <p>A symbol consisting of a thermometer with a diagonal slash through it, indicating a temperature limitation.</p>   | <p>Temperature limitation</p>   |
|  <p>The CE mark of conformity, specifically 'CE 2797', indicating the notified body authorizing use of the mark.</p>  | <p>CE mark of conformity with the identification of the notified body authorizing use of the mark</p>   |
|  <p>A symbol showing a hand holding a wand with a signal arrow pointing towards a circular area, indicating where to place the telemetry wand.</p>  | <p>Place telemetry wand here</p>  |
|  <p>A symbol showing a folded sheet of paper with an arrow pointing to the top edge, indicating where to open the packaging.</p>  | <p>Open here</p>  |



**Table 7. Symbols on packaging (continued)**

| Symbol  | Description  |
|---|--|
|  | Authorized Representative in the European Community                        |
|  | Manufacturer   |
|  | C-Tick with supplier codes   |
|  | Australian Communications and Media Authority (ACMA) radio compliance mark |
| <p><b>R-NZ</b></p>  | New Zealand Radio Spectrum Management (RSM) radio compliance mark          |
|  | Australian Sponsor Address   |
|  | MR Conditional   |
|  | Pacemaker RV   |

**Table 7. Symbols on packaging (continued)**

| Symbol   | Description      |
|--|------------------|
|  | Pacemaker RA, RV |
|  | CRT-P RA, RV, LV |
|  | Uncoated device  |
|  | RF Telemetry     |

**CHARACTERISTICS AS SHIPPED**

Refer to the table for pulse generator settings at shipment (Table 8 Characteristics as shipped on page 47).

**Table 8. Characteristics as shipped**

| Parameter                | Setting   |
|--------------------------|---|
| Pacing Mode              | Storage   |
| Pacing Therapy available | DDDR  |
| Sensor                   | Accelerometer                                       |
| Sensor                   | Blend (Accel and MV) (VISIONIST and INLIVEN models) |
| Pace/Sense Configuration | RA: BI/BI   |
| Pace/Sense Configuration | RV: BI/BI   |
| Pace/Sense Configuration | LV: Off   |
| Pace/Sense Configuration | LV: BI/BI (VISIONIST X4 and VALITUDE X4 Models)     |
| Magnet Rate              | 100 min <sup>-1</sup>                               |

The pulse generator is shipped in a power-saving Storage mode to extend its shelf life. In Storage mode, all features are inactive except:

- Telemetry support, which allows interrogation and programming
- Real-time clock
- STAT PACE command

The device leaves Storage mode when one of the following actions occurs; however, programming other parameters will not affect the Storage mode:

- STAT PACE is commanded
- The pulse generator automatically detects lead insertion (refer to "Implanting the Pulse Generator" on page 61)
- Device Mode is programmed to Exit Storage

Once you have programmed the pulse generator out of Storage mode, the device cannot be reprogrammed to that mode.

### **X-RAY IDENTIFIER**

The pulse generator has an identifier that is visible on x-ray film or under fluoroscopy. This identifier provides noninvasive confirmation of the manufacturer and consists of the following:

- The letters, BSC, to identify Boston Scientific as the manufacturer.
- The number, 012, for VISIONIST and VALITUDE pulse generators.
- The number, 011, for INLIVEN, INTUA, and INVIVE pulse generators.

The x-ray identifier is embedded in the header of the device. For a left side pectoral implant, the identifier will be visible by x-ray or fluorography at the approximate location shown (Figure 1 X-ray identifier on page 49).

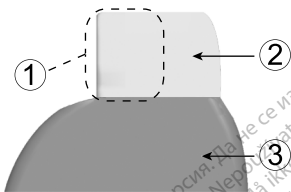

[1] X-Ray Identifier [2] Header [3] Pulse Generator Case

### Figure 1. X-ray identifier

For information on identifying the device via the PRM, refer to the PRM Operator's Manual.

The pulse generator model number is stored in device memory and is shown on the PRM Summary screen once the pulse generator is interrogated.

### PULSE GENERATOR LONGEVITY

Based on simulated studies, it is anticipated that these pulse generators have average longevity to explain as shown below.

The longevity expectations, which account for the energy used during manufacture and storage, apply at the conditions shown in the table along with the following:

- Assumes 70 min<sup>-1</sup> LRL, DDDR mode; 100% biventricular pacing; 15% atrium pacing and 0.4 ms pacing Pulse Width (RA, RV, LV); RA Impedance 500 Ω; sensors On.

- These calculations also assume EGM Onset is on, and that the pulse generator spends 6 months in Storage mode during shipping and storage.

The following longevity tables and conditions of use apply to VISIONIST and VALITUDE devices.

**Table 9. Pulse generator life expectancy estimation (implant to explant)**

| All Models <sup>a</sup> |       |   |              |                                      |
|-------------------------|-------|---|--------------|--------------------------------------|
| Pacing Amplitude        |       | Longevity (years) at 500 $\Omega$ and 700 $\Omega$ Pacing Impedance (RV and LV) |              |                                      |
| RA/RV                   | LV    | 500 $\Omega$  | 700 $\Omega$ | 700 $\Omega$ , No MV/RS <sup>b</sup> |
| 2.0 V                   | 2.0 V | 12.4  | 13.1         | 13.8                                 |
| 2.0 V                   | 3.0 V | 10.9  | 11.8         | 12.4                                 |
| 2.0 V                   | 3.5 V | 10.1  | 11.1         | 11.6                                 |
| 2.5 V                   | 3.0 V | 10.3  | 11.2         | 11.7                                 |
| 2.5 V                   | 3.5 V | 9.6   | 10.6         | 11.0                                 |
| 3.5 V                   | 3.5 V | 8.3   | 9.4          | 9.7                                  |
| 3.5 V                   | 5.0 V | 6.7   | 7.8          | 8.0                                  |

- Assumes ZIP wandless telemetry use for 3 hours at implant and for 40 minutes annually for in-clinic follow-up checks.
- Assumes Minute Ventilation (MV)/Respiratory Sensor (RS) is Off.

Longevities at an LRL of 70 min<sup>-1</sup>, 500 Ω, 0.5 ms, 100% paced, sensors On, and pacing mode most comprehensive are: All models at 2.5 V = 8.9 years, at 5.0 V = 3.5 years.

**NOTE:** *The energy consumption in the longevity table is based upon theoretical electrical principles and verified via bench testing only.*

The pulse generator longevity may increase with a decrease in any of the following:

- Pacing rate
- Pacing pulse amplitude(s)
- Pacing pulse width(s)
- Percentage of paced to sensed events

Longevity is also affected in the following circumstances:

- A decrease in pacing impedance may reduce longevity.
- When Patient Triggered Monitor is programmed to On for 60 days, longevity is reduced by approximately 5 days.
- One hour of additional ZIP wandless telemetry reduces longevity by approximately 6 days.
- The following LATITUDE usage will decrease longevity by approximately 7 months: Daily Device Check on, monthly Full Interrogations (scheduled remote follow ups, and quarterly patient-initiated interrogations). Daily Device Checks and quarterly Full Interrogations will decrease longevity by approximately 6 months.
- Five patient-initiated LATITUDE Communicator interrogations per week for a year reduces longevity by approximately 30 days.
- 24 hours in MRI Protection Mode reduces longevity by approximately 7 days.
- An additional 6 months in Storage mode prior to implant will reduce longevity by 60 days. Assumes implanted settings of 70 min<sup>-1</sup> LRL; DDDR mode; 15% atrium pacing; 100% biventricular pacing; 0.4 ms

pacing Pulse Width; 500  $\Omega$  pacing Impedance; 2.5 V pacing pulse Amplitude (RA, RV); 3.5 V pacing pulse Amplitude (LV).

Device longevity may also be affected by:

- Tolerances of electronic components
- Variations in programmed parameters
- Variations in usage as a result of patient condition

The following longevity tables and conditions of use apply to INLIVEN, INTUA, and INVIVE devices.

**Table 10. Pulse generator life expectancy estimation (implant to explant)**

| All Models <sup>a, b</sup> |       |   |              |
|----------------------------|-------|---|--------------|
| Pacing Amplitude           |       | Longevity (years) at 500 $\Omega$ and 700 $\Omega$ Pacing Impedance (RV and LV) |              |
| RA/RV                      | LV    | 500 $\Omega$  | 700 $\Omega$ |
| 2.5 V                      | 3.0 V | 8.4   | 9.1          |
| 2.5 V                      | 3.5 V | 7.9   | 8.6          |
| 3.5 V                      | 3.5 V | 6.9   | 7.8          |
| 3.5 V                      | 5.0 V | 5.6   | 6.5          |

a. Assumes ZIP wandless telemetry use for 3 hours at implant and for 20 minutes during each quarterly follow-up.

b. Assumes standard use of the LATITUDE Communicator as follows: Daily Alert Interrogation On, weekly scheduled remote follow ups, and quarterly patient-initiated interrogations.



Longevities at an LRL of 70 min<sup>-1</sup>, 500 Ω, 0.5 ms, 100% paced, sensors On, and pacing mode most comprehensive are: All models at 2.5 V = 7.3 years, at 5.0 V = 3.9 years.

**NOTE:** *The energy consumption in the longevity table is based upon theoretical electrical principles and verified via bench testing only.*

The pulse generator longevity may increase with a decrease in any of the following:

- Pacing rate
- Pacing pulse amplitude(s)
- Pacing pulse width(s)
- Percentage of paced to sensed events

Longevity is also affected in the following circumstances:

- A decrease in pacing impedance may reduce longevity.
- When the MV/Respiratory Sensor is programmed Off for the life of the device, longevity is increased by approximately 4 months.
- When Patient Triggered Monitor is programmed to On for 60 days, longevity is reduced by approximately 5 days.
- One hour of additional ZIP wireless telemetry reduces longevity by approximately 9 days.
- Five patient-initiated LATITUDE Communicator interrogations per week for a year reduces longevity by approximately 14 days.
- An additional 6 months in Storage mode prior to implant will reduce longevity by 60 days. Assumes implanted settings of 70 min<sup>-1</sup> LRL; DDDR mode; 15% atrium pacing; 100% biventricular pacing; 0.4 ms pacing Pulse Width; 500 Ω pacing Impedance; 2.5 V pacing pulse Amplitude (RA, RV); 3.5 V pacing pulse Amplitude (LV).

Device longevity may also be affected by:

- Tolerances of electronic components
- Variations in programmed parameters
- Variations in usage as a result of patient condition

Refer to the PRM Summary and Battery Detail Summary screens for an estimate of pulse generator longevity specific to the implanted device.

## **WARRANTY INFORMATION**

A limited warranty certificate for the pulse generator is available at [www.bostonscientific.com](http://www.bostonscientific.com). For a copy, contact Boston Scientific using the information on the back cover.

## **PRODUCT RELIABILITY**

It is Boston Scientific's intent to provide implantable devices of high quality and reliability. However, these devices may exhibit malfunctions that may result in lost or compromised ability to deliver therapy. These malfunctions may include the following:

- Premature battery depletion
- Sensing or pacing issues
- Error codes
- Loss of telemetry

Refer to Boston Scientific's CRM Product Performance Report on [www.bostonscientific.com](http://www.bostonscientific.com) for more information about device performance, including the types and rates of malfunctions that these devices have experienced historically. While historical data may not be predictive of future device performance, such data can provide important context for understanding the overall reliability of these types of products.

Sometimes device malfunctions result in the issuance of product advisories. Boston Scientific determines the need to issue product advisories based on the estimated malfunction rate and the clinical implication of the

malfunction. When Boston Scientific communicates product advisory information, the decision whether to replace a device should take into account the risks of the malfunction, the risks of the replacement procedure, and the performance to date of the replacement device.

## **PATIENT COUNSELING INFORMATION**

The following topics should be discussed with the patient prior to discharge.

- External defibrillation—the patient should contact their physician to have their pulse generator system evaluated if they receive external defibrillation
- Signs and symptoms of infection
- Symptoms that should be reported (e.g., sustained high-rate pacing requiring reprogramming)
- Protected environments—the patient should seek medical guidance before entering areas protected by a warning notice that prevents entry by patients who have a pulse generator
- MRI scanning—the physician following the patient's device must be consulted to determine eligibility for an MRI scan
- Avoiding potential sources of EMI in home, work, and medical environments
- Reliability of their pulse generator ("Product Reliability" on page 54)
- Activity restrictions (if applicable)
- Minimum heart rate (lower rate limit of the pulse generator)
- Frequency of follow up
- Travel or relocation—Follow-up arrangements should be made in advance if the patient is leaving the country of implant
- Patient ID card—a patient ID card is packaged with the device, and the patient should be advised to carry it at all times

**NOTE:** Patients should present their patient ID card before entering protected environments such as for MRI scanning.

### **Patient Handbook**

A copy of the Patient Handbook is available for the patient, patient's relatives, and other interested people.

It is recommended that you discuss the information in the Patient Handbook with concerned individuals both before and after implantation so they are fully familiar with pulse generator operation.

In addition, for patients with an ImageReady MR Conditional Pacing System, an MRI Patient Guide is available.

For additional copies, contact Boston Scientific using the information on the back cover.

### **LEAD CONNECTIONS**

Lead connections are illustrated below.

**CAUTION:** Prior to implantation, confirm the lead-to-pulse generator compatibility. Using incompatible leads and pulse generators can damage the connector and/or result in potential adverse consequences, such as undersensing of cardiac activity or failure to deliver necessary therapy.

**NOTE:** Use of Boston Scientific MR Conditional leads is required for an implanted system to be considered MR Conditional. Refer to the MRI Technical Guide for model numbers of pulse generators, leads, accessories, and other system components needed to satisfy the Conditions of Use.

**CAUTION:** If the Lead Configuration is programmed to Bipolar when a unipolar lead is implanted, pacing will not occur.

**The following lead connections apply to VISIONIST and VALITUDE devices.**

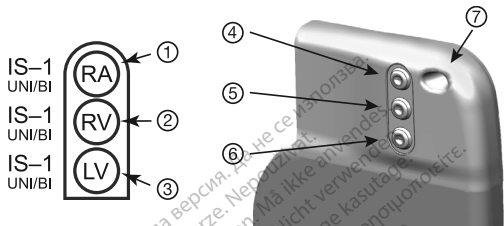

[1] RA: White [2] RV: White [3] LV: Green [4] RA [5] RV [6] LV [7] Suture Hole

**Figure 2. Lead connections and setscrew locations, RA: IS-1, RV: IS-1, LV: IS-1**

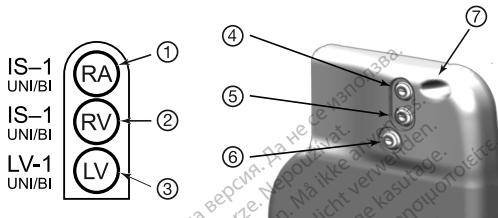

[1] RA: White [2] RV: White [3] LV: Green [4] RA [5] RV [6] LV [7] Suture Hole

**Figure 3. Lead connections and setscrew locations, RA: IS-1, RV: IS-1, LV: LV-1**

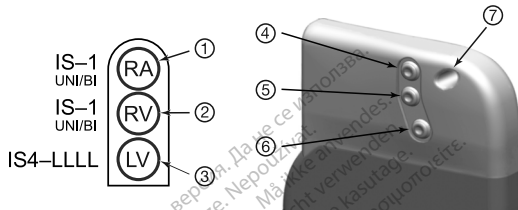

[1] RA: White [2] RV: White [3] LV: Green [4] RA [5] RV [6] LV [7] Suture Hole

**Figure 4. Lead connections and setscrew locations, RA: IS-1, RV: IS-1, LV: IS4-LLLL**

**The following lead connections apply to INLIVEN, INTUA, and INVIVE devices.**

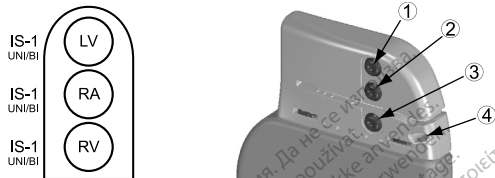

[1] LV [2] RA [3] RV [4] Suture Hole

**Figure 5. Lead connections and setscrew locations, RA: IS-1, RV: IS-1, LV: IS-1**



[1] LV [2] RA [3] RV [4] Suture Hole

**Figure 6. Lead connections and setscrew locations, RA: IS-1, RV: IS-1, LV: LV-1**

**NOTE:** The pulse generator case is used as a pace electrode when the pulse generator has been programmed to a unipolar lead setting.



## IMPLANTING THE PULSE GENERATOR

Implant the pulse generator by performing the following steps in the sequence provided. Some patients may require pacing therapies immediately upon connecting the leads to the pulse generator. If modifications to the nominal settings are needed, consider programming the pulse generator before or in parallel with implanting the lead system and forming the implantation pocket.

**WARNING:** Implant of the system cannot be performed in an MRI site Zone III (and higher) as defined by the American College of Radiology Guidance Document for Safe MR Practices<sup>6</sup>. Some of the accessories packaged with pulse generators and leads, including the torque wrench and stylet wires, are not MR Conditional and should not be brought into the MRI scanner room, the control room, or the MRI site Zone III or IV areas.

### Step A: Check Equipment

It is recommended that instrumentation for cardiac monitoring, defibrillation, and lead signal measurement should be available during the implant procedure. This includes the PRM system with its related accessories and the software application. Before beginning the implantation procedure, become completely familiar with the operation of all the equipment and the information in the respective operator's and user's manuals. Verify the operational status of all equipment that may be used during the procedure. In case of accidental damage or contamination, the following should be available:

- Sterile duplicates of all implantable items
- Sterile wand
- Sterile PSA cables
- Torque and non-torque wrenches

During the implantation procedure, always have a standard external defibrillator with external pads or paddles available for use.

---

6. Kanal E, et al., American Journal of Roentgenology 188:1447-74, 2007.

## Step B: Interrogate and Check the Pulse Generator

To maintain sterility, test the pulse generator as described below before opening the sterile blister tray. The pulse generator should be at room temperature to ensure accurately measured parameters.

1. Interrogate the pulse generator using the PRM. Verify that the pulse generator's Device Mode is programmed to Storage. If otherwise, contact Boston Scientific using the information on the back cover.

To begin a ZIP telemetry session for VISIONIST and VALITUDE devices, verify that the ZOOM Wireless Transmitter is connected to the PRM via the USB cable and that the green light on top of the transmitter is illuminated. To initiate communication with all devices, position the wand over the PG and use the PRM to Interrogate the pulse generator. Keep the telemetry wand in position until either a message appears, indicating that the telemetry wand may be removed from proximity of the pulse generator, or the ZIP telemetry light illuminates on the PRM system. Select the End Session button to quit a telemetry session and return to the startup screen. Radio frequency interference may temporarily disrupt ZIP telemetry communication. Increasing the distance from the source of interfering signals or repositioning the ZOOM Wireless Transmitter may improve ZIP telemetry performance. If ZIP telemetry performance is not satisfactory, the option of using wandless telemetry is available.

2. Review the pulse generator's current battery status. Counters should be at zero. If the pulse generator battery status is not at full capacity, do not implant the pulse generator. Contact Boston Scientific using the information on the back cover.
3. If a unipolar pacing configuration is required at implant, program the Lead Configuration to Unipolar before implant.

## Step C: Implant the Lead System

The pulse generator requires a lead system for pacing and sensing.

Selection of lead configuration and specific surgical procedures is a matter of professional judgment. The following leads are available for use with the pulse generator depending on the device model.

- Unipolar or bipolar atrial lead
- Unipolar or bipolar right ventricular lead.
- Unipolar or bipolar left ventricular lead
- Quadripolar left ventricular lead

**NOTE:** *Using bipolar pacing leads will reduce the chance of myopotential sensing.*

**NOTE:** *If a coronary venous lead cannot be used and the physician's medical judgment indicates that a limited left thoracotomy is justified to place an epicardial lead, the use of either a sutureable, steroid-eluting pace/sense epicardial lead or sutureless epicardial pace/sense lead is recommended.*

**NOTE:** *Use of an RA or RV unipolar lead with an ImageReady pulse generator is inconsistent with the Conditions of Use required for MR Conditional status. Refer to the ImageReady MR Conditional Pacing System MRI Technical Guide for information about MRI scanning.*

**NOTE:** *Use of Boston Scientific MR Conditional leads is required for an implanted system to be considered MR Conditional. Refer to the MRI Technical Guide for model numbers of pulse generators, leads, accessories, and other system components needed to satisfy the Conditions of Use, and for warnings and precautions regarding MRI scanning.*

**CAUTION:** The absence of a lead or plug in a lead port may affect device performance. If a lead is not used, be sure to properly insert a plug in the unused port, and then tighten the setscrew onto the plug.

**CAUTION:** If a dual-chamber device is programmed to AAI(R), ensure that a functional RV lead is present. In the absence of a functional RV lead, programming to AAI(R) may result in undersensing or oversensing.

**CAUTION:** Do not suture directly over the lead body, as this may cause structural damage. Use the suture sleeve to secure the lead proximal to the venous entry site to prevent lead movement.

Implant the leads via the surgical approach chosen.

When replacing a previously implanted pulse generator, it may be necessary to use an adapter to enable the new pulse generator to be connected to the existing leads. When using an adapter, follow the connection procedure described in the applicable adapter product data sheet. Always connect the adapter to the lead and repeat threshold and sensing measurements before connecting the adapter to the pulse generator.

**NOTE:** *Should lead performance changes occur which cannot be resolved with programming, the lead may need to be replaced if no adapter is available.*

**NOTE:** *Use of adapters is inconsistent with the Conditions of Use required for MR Conditional status. Refer to the MRI Technical Guide for warnings, precautions, and other information about MRI scanning.*

#### **Step D: Take Baseline Measurements**

Once the leads are implanted, take baseline measurements. Evaluate the lead signals. If performing a pulse generator replacement procedure, existing leads should be reevaluated, (e.g., signal amplitudes, pacing thresholds, and impedance). The use of radiography may help ensure lead position and integrity. If testing results are unsatisfactory, lead system repositioning or replacement may be required.

- Connect the pace/sense lead(s) to a pacing system analyzer (PSA).

**WARNING:** For leads that require the use of a Connector Tool, use caution handling the lead terminal when the Connector Tool is not present on the lead. Do not directly contact the lead terminal with any surgical instruments or electrical connections such as PSA (alligator) clips, ECG connections, forceps, hemostats, and clamps. This could damage the lead terminal, possibly compromising the sealing integrity and result in loss of therapy or inappropriate therapy, such as a short within the header.

- Pace/sense lead measurements, measured approximately 10 minutes after initial placement (acute) or during a replacement procedure (chronic), are listed below. Values other than what are suggested in the table may be clinically acceptable if appropriate sensing can be documented with the currently programmed values. Consider reprogramming the sensitivity parameter if inappropriate sensing is observed. Note that the pulse generator measurements may not exactly correlate to the PSA measurements due to signal filtering.

**Table 11. Lead measurements**

|                                    | <b>Pace/ sense lead (acute)</b>               | <b>Pace/ sense lead (chronic)</b>             |
|------------------------------------|---|---|
| R-Wave Amplitude <sup>a b</sup>    | > 5 mV  | > 5 mV  |
| P-Wave Amplitude <sup>a b</sup>    | > 1.5 mV                                      | > 1.5 mV                                      |
| R-Wave Duration <sup>b c d</sup>   | < 100 ms                                      | < 100 ms                                      |
| Pacing Threshold (right ventricle) | < 1.5 V endocardial<br>< 2.0 V epicardial     | < 3.0 V endocardial<br>< 3.5 V epicardial     |
| Pacing Threshold (left ventricle)  | < 2.5 V coronary venous<br>< 2.0 V epicardial | < 3.5 V coronary venous<br>< 3.5 V epicardial |
| Pacing Threshold (atrium)          | < 1.5 V endocardial                           | < 3.0 V endocardial                           |

**Table 11. Lead measurements (continued)**

|   | <b>Pace/ sense lead (acute)</b>   | <b>Pace/ sense lead (chronic)</b>   |
|---|---|---|
| Lead impedance (at 5.0 V and 0.5 ms atrium and right ventricle) | > programmed Low Impedance Limit <sup>e</sup><br>< programmed High Impedance Limit <sup>f</sup> | > programmed Low Impedance Limit <sup>e</sup><br>< programmed High Impedance Limit <sup>f</sup>     |
| Lead impedance (at 5.0 V and 0.5 ms left ventricle)             | > programmed Low Impedance Limit <sup>e</sup><br>< programmed High Impedance Limit <sup>f</sup> | > programmed Low Impedance Limit <sup>e</sup><br>< the programmed High Impedance Limit <sup>f</sup> |

- Amplitudes less than 2 mV cause inaccurate rate counting in the chronic state, and result in inability to sense a tachyarrhythmia or the misinterpretation of a normal rhythm as abnormal.
- Lower R-wave amplitudes and longer duration may be associated with placement in ischemic or scarred tissues. Since signal quality may deteriorate chronically, efforts should be made to meet the above criteria by repositioning the leads to obtain signals with the largest possible amplitude and shortest duration.
- Durations longer than 135 ms (the pulse generator's refractory period) may result in inaccurate cardiac rate determination, inability to sense a tachyarrhythmia, or in the misinterpretation of a normal rhythm as abnormal.
- This measurement is not inclusive of current of injury.
- The Low Impedance Limit is programmable between 200–500 Ω.
- The High Impedance Limit is programmable between 2000 Ω and either 2500 Ω or 3000 Ω depending on the pulse generator model.

If the lead integrity is in question, standard lead troubleshooting tests should be used to assess the lead system integrity. Troubleshooting tests include, but are not limited to, the following:

- Electrogram analysis with pocket manipulation
- X-ray or fluoroscopic image review

- Invasive visual inspection

### Step E: Form the Implantation Pocket

Using standard operating procedures to prepare an implantation pocket, choose the position of the pocket based on the implanted lead configuration and the patient's body habitus. Giving consideration to patient anatomy and pulse generator size and motion, gently coil any excess lead and place adjacent to the pulse generator. It is important to place the lead into the pocket in a manner that minimizes lead tension, twisting, sharp angles, and/or pressure. Pulse generators are typically implanted subcutaneously in order to minimize tissue trauma and facilitate explant. However, deeper implantation (e.g., subpectoral) may help avoid erosion or extrusion in some patients.

If an abdominal implant is suitable, it is recommended that implantation occur on the left abdominal side.

**NOTE:** *An abdominal implant site is inconsistent with the Conditions of Use for MR Conditional MRI scanning. Refer to the MRI Technical Guide for warnings, precautions and other information about MRI scanning.*

If it is necessary to tunnel the lead, consider the following:

**WARNING:** For leads that require the use of a Connector Tool, use caution handling the lead terminal when the Connector Tool is not present on the lead. Do not directly contact the lead terminal with any surgical instruments or electrical connections such as PSA (alligator) clips, ECG connections, forceps, hemostats, and clamps. This could damage the lead terminal, possibly compromising the sealing integrity and result in loss of therapy or inappropriate therapy, such as a short within the header.

**WARNING:** Do not contact any other portion of the IS4–LLLL lead terminal, other than the terminal pin, even when the lead cap is in place.

- If a compatible tunneler is not used, cap the lead terminal pins. A Penrose drain, large chest tube, or tunneling tool may be used to tunnel the leads.
- For IS4–LLLL leads, if a compatible tunneling tip and/or tunneler kit is not used, cap the lead terminal and grip only the terminal pin with a hemostat or equivalent.

- Gently tunnel the leads subcutaneously to the implantation pocket, if necessary.
- Reevaluate all lead signals to determine if any of the leads have been damaged during the tunneling procedure.

If the leads are not connected to a pulse generator at the time of lead implantation, they must be capped before closing the incision.

### Step F: Connect the Leads to the Pulse Generator

To connect leads to the pulse generator, use only the tools provided in the pulse generator sterile tray or accessory kit. Failure to use the supplied torque wrench may result in damage to the setscrews, seal plugs, or connector threads. Do not implant the pulse generator if the seal plugs appear to be damaged. Retain the tools until all testing procedures are complete and the pulse generator is implanted.

### Automatic Lead Detection

Until a right ventricular lead is detected, the lead impedance is measured in both unipolar and bipolar configurations. Upon insertion of the lead into the header the impedance measurement circuit will detect an impedance which indicates that the device is implanted (automatic lead detection). If the impedance is in range (200-2000  $\Omega$ , inclusive) the pulse generator will automatically switch to the nominal parameters and start sensing and delivering therapy. The pulse generator can also be programmed out of the Storage mode prior to implant using the Programmer.

**NOTE:** *If the lead being used for automatic lead detection is unipolar, an in-range impedance will not be obtained until the pulse generator is in stable contact with the subcutaneous tissue of the pocket.*

**NOTE:** *If the lead used for automatic lead detection has high impedance (greater than 2000  $\Omega$ ), it will not be detected, and sensing and therapy will not start automatically.*

**NOTE:** *Arrhythmia Logbook and stored EGM data will not be stored for the first two hours after the lead is detected except for PaceSafe and patient triggered episodes.*



For VISIONIST and VALITUDE devices, Automatic Lead Recognition (ALR) determines if the detected RV lead is unipolar or bipolar, and ensures that the RV Pace/RV Sense lead configuration matches the detected lead type.

ALR is nominally On and remains programmable to On/Off until a lead is detected.

When ALR detects an in-range bipolar impedance measurement (200-2000  $\Omega$ , inclusive), the programmed Bipolar RV lead configuration is retained. If an out-of-range bipolar impedance measurement is detected, ALR configures the RV Pace and RV Sense parameters for Unipolar pacing and sensing. This allows RV sensing and pacing to begin without programmer interaction when the RV lead is attached. The device continues to measure the bipolar RV lead impedance for a period of two hours to confirm recognition of a unipolar lead.

If the device is programmed out of Storage, asynchronous pacing spikes could be observed on intracardiac EGMs before bipolar RV lead insertion or before placing the pulse generator into the subcutaneous pocket if a unipolar RV lead is present. These subthreshold spikes will not occur once a bipolar RV lead is detected in the header or when contact between the pacemaker case and subcutaneous tissue completes the normal pacing circuit for a unipolar RV lead. If the device exits Storage as the result of automatic lead detection, the pulse generator may take up to 2 seconds plus one LRL interval before pacing begins as a result of lead detection.

Leads should be connected to the pulse generator in the following sequence (for pulse generator header and setscrew location illustrations, refer to "Lead Connections" on page 56):

1. **Right ventricle.** Connect the RV lead first because it is required to establish RV-based timing cycles that yield appropriate sensing and pacing in all chambers, regardless of the programmed configuration.

**NOTE:** *Tightening the RV setscrew is not required for automatic lead detection to occur but should be done to ensure full electrical contact.*

- In models with an IS-1 RV lead port, insert and secure the terminal pin of an IS-1 RV pace/sense lead.

2. **Right atrium.**

- In models with an IS-1 RA lead port, insert and secure the terminal pin of an IS-1 atrial pace/sense lead.

### 3. Left ventricle.

- In models with an IS-1 LV lead port, insert and secure the terminal pin of an IS-1 coronary venous pace/sense lead.
- In models with an LV-1 LV lead port, insert and secure the terminal pin of an LV-1 coronary venous pace/sense lead.
- In models with a IS4-LLLL LV lead port, insert and secure the terminal pin of a IS4-LLLL lead.

Connect each lead to the pulse generator by following these steps (for additional information about the torque wrench, refer to "Bidirectional Torque Wrench" on page 76):

1. Check for the presence of any blood or other body fluids in the lead ports on the pulse generator header. If fluid inadvertently enters the ports, clean them thoroughly with sterile water.
2. If applicable, remove and discard the tip protection before using the torque wrench.
3. Gently insert the torque wrench blade into the setscrew by passing it through the preslit, center depression of the seal plug at a 90° angle (Figure 7. Inserting the torque wrench on page 71). This will open up the seal plug, relieving any potential pressure build-up from the lead port by providing a pathway to release trapped fluid or air.

**NOTE:** Failure to properly insert the torque wrench in the preslit depression of the seal plug may result in damage to the plug and its sealing properties.

**CAUTION:** Do not insert a lead into the pulse generator connector without taking the following precautions to ensure proper lead insertion:

- Insert the torque wrench into the preslit depression of the seal plug before inserting the lead into the port, to release any trapped fluid or air.

- Visually verify that the setscrew is sufficiently retracted to allow insertion. Use the torque wrench to loosen the setscrew if necessary.
- Fully insert each lead into its lead port and then tighten the setscrew onto the terminal pin.

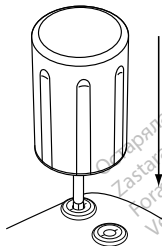
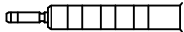

**Figure 7. Inserting the torque wrench**

4. With the torque wrench in place, fully insert the lead terminal into the lead port. The lead terminal pin should be clearly visible beyond the connector block when viewed through the side of the EasyView pulse generator header. Place pressure on the lead to maintain its position and ensure that it remains fully inserted in the lead port.

**CAUTION:** Insert the lead terminal straight into the lead port. Do not bend the lead near the lead-header interface. Improper insertion can cause insulation or connector damage.

**NOTE:** If necessary, lubricate the entire lead terminal (area shown in Figure 8 IS4 Lead Terminal on page 72) sparingly with sterile water or sterile mineral oil to make insertion easier.



**Figure 8. IS4 Lead Terminal**

**NOTE:** For IS-1 leads, be certain that the terminal pin visibly extends beyond the connector block at least 1 mm.

**NOTE:** For IS4-LLLL leads, the terminal pin must be inserted beyond the setscrew block to enable a proper connection. Visualization of the terminal pin insertion indicator beyond the setscrew block may be used to confirm that the terminal pin is fully inserted into the lead port.

5. Apply gentle downward pressure on the torque wrench until the blade is fully engaged within the setscrew cavity, taking care to avoid damage to the seal plug. Tighten the setscrew by slowly turning the torque wrench clockwise, until it ratchets once. The torque wrench is preset to apply the proper amount of force to the captive setscrew; additional rotation and force is unnecessary.
6. Remove the torque wrench.
7. Apply gentle traction to the lead to ensure a secure connection.
8. If the lead terminal is not secure, attempt to reseat the setscrew. Reinsert the torque wrench as described above, and loosen the setscrew by slowly turning the wrench counterclockwise, until the lead is loose. Then repeat the sequence above.
9. If a lead port is not used, insert a plug into the unused port and tighten the setscrew.

**CAUTION:** The absence of a lead or plug in a lead port may affect device performance. If a lead is not used, be sure to properly insert a plug in the unused port, and then tighten the setscrew onto the plug.

### **Step G: Evaluate Lead Signals**

1. Insert the pulse generator into the implantation pocket.

- Evaluate the pace/sense lead signals by viewing the real-time EGMs and markers. Lead measurements should reflect those above (Table 11 Lead measurements on page 65).

Depending on the patient's intrinsic rhythm, it may be necessary to temporarily adjust pacing parameters to allow assessment of pacing and sensing. If proper pacing and/or sensing are not demonstrated, disconnect the lead from the pulse generator and visually inspect the connector and leads. If necessary, retest the lead.

**CAUTION:** Take care to ensure that artifacts from the ventricles are not present on the atrial channel, or atrial oversensing may result. If ventricular artifacts are present in the atrial channel, the atrial lead may need to be repositioned to minimize its interaction.

- Evaluate all lead impedances.

**CAUTION:** Patients should be tested for diaphragmatic stimulation by pacing the LV lead through the pulse generator at 7.5 V and adjusting the lead configurations and lead position as necessary. PSA testing at higher outputs (e.g., 10.0 V) may also be considered to better characterize stimulation margins. The probability of diaphragmatic stimulation increases when a pacing system includes an LV lead because of this lead's proximity to the phrenic nerve.

For VISIONIST and VALITUDE devices, the High Impedance Limit is nominally set to 2000  $\Omega$ , and is programmable between 2000 and 3000  $\Omega$  in 250  $\Omega$  increments. The Low Impedance Limit is nominally set to 200  $\Omega$ , and is programmable between 200 and 500  $\Omega$  in 50  $\Omega$  increments.

For INLIVEN, INTUA, and INVIVE devices, the High Impedance Limit is nominally set to 2000  $\Omega$ , and is programmable between 2000 and 2500  $\Omega$  in 250  $\Omega$  increments. The Low Impedance Limit is nominally set to 200  $\Omega$ , and is programmable between 200 and 500  $\Omega$  in 50  $\Omega$  increments.

Consider the following factors when choosing a value for the impedance limits:

- For chronic leads, historical impedance measurements for the lead, as well as other electrical performance indicators such as stability over time

- For newly implanted leads, the starting measured impedance value

**NOTE:** Depending on lead maturation effects, during follow-up testing the physician may choose to reprogram the impedance limits.

- Pacing dependence of the patient
- Recommended impedance range for the lead(s) being used, if available

#### **Step H: Program the Pulse Generator**

1. Check the Programmer Clock and set and synchronize the pulse generator as necessary so that the proper time appears on printed reports and PRM strip chart recordings.
2. Program the pulse generator appropriately if a lead port(s) is not used.

Consider the following when programming the pulse generator:

- The minimum 2X voltage or 3X pulse width safety margin is recommended for each chamber based on the capture thresholds, which should provide an adequate safety margin and help preserve battery longevity.
- Programming a longer blanking period may increase the likelihood of undersensing R-waves.
- Programming a shorter blanking period may increase the likelihood for ventricular oversensing of an atrial paced event.
- When programming MTR, consider the patient's condition, age, general health, sinus node function, and that a high MTR may be inappropriate for patients who experience angina or other symptoms of myocardial ischemia at higher rates.
- When programming MSR, consider the patient's condition, age, general health and that adaptive-rate pacing at higher rates may be inappropriate for patients who experience angina or other symptoms of myocardial ischemia at these higher rates. An appropriate MSR should be selected based on an assessment of the highest pacing rate that the patient can tolerate well.

- For heart failure patients with second- and third-degree AV block, programming long Atrial Refractory periods in combination with certain AV Delay periods can cause 2:1 block to occur abruptly at the programmed MTR.
- Certain conditions may cause the temporary loss of CRT or AV synchrony due to Wenckebach-like behavior, and heart failure patients may become symptomatic if CRT is compromised. Consider patient condition when programming features such as MTR, AFR, Rate Smoothing, and features that switch to VVI or VVI-like behavior.
- Prior to programming RVAT on, consider performing a Commanded Ventricular Automatic Threshold Measurement to verify that the feature functions as expected.
- Using Fixed Sensing instead of AGC for patients who are pacemaker-dependent or have leads programmed to unipolar.
- In pacemaker-dependent patients, use care when considering setting Noise Response to Inhibit Pacing as pacing will not occur in the presence of noise.
- To resolve suspected impedance-based interactions with the MV/Respiratory Sensor, program the sensor to Off.

### Step I: Implant the Pulse Generator

1. Verify magnet function and wanded telemetry to ensure the pulse generator is within acceptable range to initiate interrogation.
2. Ensure that the pulse generator has good contact with surrounding tissue of the implantation pocket, and then suture it in place to minimize device migration (for suture hole location illustrations, refer to "Lead Connections" on page 56). Gently coil excess lead and place adjacent to the pulse generator. Flush the pocket with saline solution, if necessary, to avoid a dry pocket.

**WARNING:** Do not kink, twist, or braid the lead with other leads as doing so could cause lead insulation abrasion damage or conductor damage.

3. Close the implantation pocket. Consideration should be given to place the leads in a manner to prevent contact with suture materials. It is recommended that absorbable sutures be used for closure of tissue layers.
  4. If Electrocautery mode was used during the implant procedure, cancel it when done.
  5. Confirm final programmed parameters.
- CAUTION:** Following any Sensitivity parameter adjustment or any modification of the sensing lead, always verify appropriate sensing. Programming Sensitivity to the highest value (lowest sensitivity) may result in undersensing of cardiac activity. Likewise, programming to the lowest value (highest sensitivity) may result in oversensing of non-cardiac signals.
6. Use the PRM to print out parameter reports and save all patient data.

#### **Step J: Complete and Return the Implantation Form**

Within ten days of implantation, complete the Warranty Validation and Lead Registration form and return the original to Boston Scientific along with a copy of the patient data saved from the PRM. This information enables Boston Scientific to register each implanted pulse generator and set of leads, and provide clinical data on the performance of the implanted system. Keep a copy of the Warranty Validation and Lead Registration form and programmer printouts, and the original patient data for the patient's file.

#### **BIDIRECTIONAL TORQUE WRENCH**

A torque wrench (model 6628) is included in the sterile tray with the pulse generator, and is designed for tightening and loosening #2-56 setscrews, captured setscrews, and setscrews on this and other Boston Scientific pulse generators and lead accessories that have setscrews that spin freely when fully retracted (these setscrews typically have white seal plugs).

This torque wrench is bidirectional, and is preset to apply adequate torque to the setscrew and will ratchet when the setscrew is secure. The ratchet release mechanism prevents overtightening that could result in device



damage. To facilitate the loosening of tight extended setscrews, this wrench applies more torque in the counterclockwise direction than in the clockwise direction.

**NOTE:** *As an additional safeguard, the tip of the torque wrench is designed to break off if used to overtighten beyond preset torque levels. If this occurs, the broken tip must be extracted from the setscrew using forceps.*

This torque wrench may also be used for loosening setscrews on other Boston Scientific pulse generators and lead accessories that have setscrews that tighten against a stop when fully retracted (these setscrews typically have clear seal plugs). However, when retracting these setscrews, stop turning the torque wrench when the setscrew has come in contact with the stop. The additional counterclockwise torque of this wrench may cause these setscrews to become stuck if tightened against the stop.

### **Loosening Stuck Setscrews**

Follow these steps to loosen stuck setscrews:

1. From a perpendicular position, tilt the torque wrench to the side 20° to 30° from the vertical center axis of the setscrew (Figure 9 Rotating the torque wrench to loosen a stuck setscrew on page 78).
2. Rotate the wrench clockwise (for retracted setscrew) or counterclockwise (for extended setscrew) around the axis three times, such that the handle of the wrench orbits the centerline of the screw (Figure 9 Rotating the torque wrench to loosen a stuck setscrew on page 78). The torque wrench handle should not turn or twist during this rotation.
3. As needed, you may attempt this up to four times with slightly more angle each time. If you cannot fully loosen the setscrew, use the #2 torque wrench from Wrench Kit Model 6501.
4. Once the setscrew has been freed, it may be extended or retracted as appropriate.
5. Discard the torque wrench upon completion of this procedure.

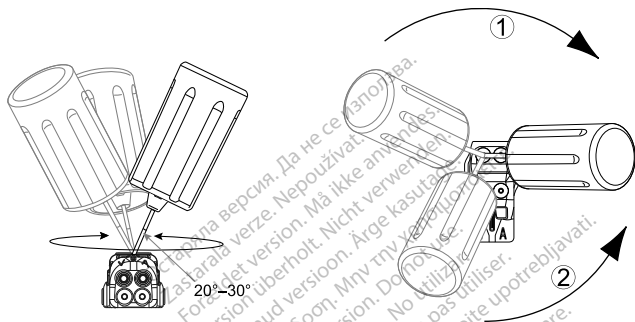

[1] Clockwise rotation to free setscrews stuck in the retracted position [2] Counterclockwise rotation to free setscrews stuck in the extended position

### Figure 9. Rotating the torque wrench to loosen a stuck setscrew

#### FOLLOW UP TESTING

It is recommended that device functions be evaluated with periodic follow-up testing by trained personnel. Follow up guidance below will enable thorough review of device performance and associated patient health status throughout the life of the device (refer to the information within the "Program the Pulse Generator" step in "Implanting the Pulse Generator" on page 61).

#### Predischarge Follow Up

The following procedures are typically performed during the predischarge follow up test using PRM telemetry:

1. Interrogate the pulse generator and review the Summary screen.
2. Verify pacing thresholds, lead impedance, and amplitude of intrinsic signals.
3. Review counters and histograms.
4. When all testing is complete, perform a final interrogation and save all the patient data.
5. Print the Quick Notes and Patient Data reports to retain in your files for future reference.
6. Clear the counters and histograms so that the most recent data will be displayed at the next follow up session. Counters and histograms can be cleared by pressing Reset on the Histogram screen, Tachy Counters screen, or Brady Counters screen.

### **Routine Follow Up**

During early and middle life of the device, monitor performance by routine follow up one month after the pre-discharge check and at least annually thereafter. Office visits may be supplemented by remote monitoring where available. As always, the physician should evaluate the patient's current health status, device status and parameter values, and local medical guidelines to determine the most appropriate follow up schedule.

When the device reaches One Year Remaining status and/or a Magnet Rate of 90 min<sup>-1</sup> is observed, follow up at least every three months to facilitate timely detection of replacement indicators.

**NOTE:** *Because the duration of the device replacement timer is three months (starting when Explant status is reached), three month follow up frequency is particularly important after the One Year Remaining status is reached.*

Consider performing the following procedures during a routine follow-up test:

1. Interrogate the pulse generator and review the Summary screen.
2. Verify pacing thresholds, lead impedance, and amplitude of intrinsic signals.
3. Print the Quick Notes and Patient Data reports to retain in your files for future reference.
4. Review the Arrhythmia Logbook screen and for episodes of interest, print episode details and stored electrogram information.
5. Clear the counters and histograms so that the most recent episode data will be displayed at the next follow-up session.
6. Verify that important programmed parameter values (e.g., Lower Rate Limit, AV Delay, LV Offset, Rate Adaptive Pacing, output Amplitude, Pulse Width, Sensitivity) are optimal for current patient status.

**NOTE:** *Echo-Doppler studies may be used to non-invasively evaluate AV Delay and other programming options post-implant.*

## **EXPLANATION**

**NOTE:** *Return all explanted devices to Boston Scientific. Examination of explanted devices can provide information for continued improvement in system reliability and warranty considerations.*

**WARNING:** Do not reuse, reprocess, or resterilize. Reuse, reprocessing, or resterilization may compromise the structural integrity of the device and/or lead to device failure which, in turn, may result in patient injury, illness, or death. Reuse, reprocessing, or resterilization may also create a risk of contamination of the device and/or cause patient infection or cross-infection, including, but not limited to, the transmission of infectious disease(s) from one patient to another. Contamination of the device may lead to injury, illness, or death of the patient.

Contact Boston Scientific when any of the following occur:

- When a product is removed from service.
- In the event of patient death (regardless of cause), along with an autopsy report, if performed.
- For other observation or complication reasons.

**NOTE:** *Disposal of explanted devices is subject to applicable laws and regulations. For a Returned Product Kit, contact Boston Scientific using the information on the back cover.*

**NOTE:** *Discoloration of the pulse generator may have occurred due to a normal process of anodization, and has no effect on the pulse generator function.*

**CAUTION:** Be sure that the pulse generator is removed before cremation. Cremation and incineration temperatures might cause the pulse generator to explode.

**CAUTION:** Before explanting, cleaning, or shipping the device, complete the following actions to prevent overwriting of important therapy history data:

- Program the pulse generator Brady Mode to Off
- Program Ventricular Tachy EGM Storage to Off

Clean and disinfect the device using standard biohazard handling techniques.

Consider the following items when explanting and returning devices:

- Interrogate the pulse generator and print a comprehensive report.
- Deactivate the pulse generator before explantation.
- Disconnect the leads from the pulse generator.
- If leads are explanted, attempt to remove them intact, and return them regardless of condition. Do not remove leads with hemostats or any other clamping tool that may damage the leads. Resort to tools only if manual manipulation cannot free the lead.

- Wash, but do not submerge, the devices to remove body fluids and debris using a disinfectant solution. Do not allow fluids to enter the pulse generator's header port(s).
- Use a Boston Scientific Returned Product Kit to properly package the devices, and send it to Boston Scientific.

Остаряла версия. Да не се използва.  
 Zastaralá verze. Nepoužívat.  
 Forældet version. Må ikke anvendes.  
 Version überholt. Nicht verwenden.  
 Aegunud versioon. Ärge kasutage.  
 Παλιά έκδοση. Μην την χρησιμοποιείτε.  
 Outdated version. Do not use.  
 Version obsolete. Ne pas utiliser.  
 Zastarjela verzija. Neizkoristovati.  
 Ürelet ütgaäfa. Notiö ekkü.  
 Versione obsolete. Nemojte upotrebljavati.  
 Novecojsi versija. Non utilizzate.  
 Pasenusi versija. Neizmantoť.  
 Elavult verziö. Ne használja!  
 Utdatert versjon. Nenaudokite.  
 Wersja przeterminowana. Nie używać.  
 Versão obsoleta. Não utilize.  
 Zastarana verzija. Nepoužívat.  
 Vanhentunut versio. Älä käytä.  
 Föråldrad version. Använd ej.  
 Güncel olmayan sürüm. Kullanmayın.

Остаряла версия. Да не се използва.  
Zastaralá verze. Nepoužívat.  
Forældet version. Må ikke anvendes.  
Version überholt. Nicht verwenden.  
Aegunud versioön. Äрге kasutage.  
Παλιά έκδοση. Μην την χρησιμοποιείτε.  
Outdated version. Do not use.  
Version obsoletá. Nemojte upotrebljavati.  
Zastarjela verzija. Ne uporabite.  
Úreлт útгáfa. Notið ekki.  
Versione obsoleta. Non utilizzare.  
Novecojsi versija. Neizmantoť.  
Pasenusi versija. Nenaudokite.  
Elavult verzió. Ne használja!  
Utdatert versjon. Skal ikke brukes.  
Wersja przeterminowana. Nie używać.  
Versão obsoleta. Não utilize.  
Zastarana verzija. Nepoužívat.  
Vanhentunut versio. Älä käytä.  
Zastarela različica. Ne uporabite.  
Föråldrad version. Använd ej.  
Güncel olmayan sürüm. Kullanmayın.

# Boston Scientific

For additional reference information, go to [www.bostonscientific-elabeling.com](http://www.bostonscientific-elabeling.com).



Boston Scientific Corporation  
4100 Hamline Avenue North  
St. Paul, MN 55112-5798 USA

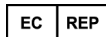

Guidant Europe NV/SA; Boston Scientific  
Green Square, Lambroekstraat 5D  
1831 Diegem, Belgium

[www.bostonscientific.com](http://www.bostonscientific.com)

1.800.CARDIAC (227.3422)  
+1.651.582.4000

© 2018 Boston Scientific Corporation or its affiliates.  
All rights reserved.

359254-035 EN Europe 2020-02

**CE 2797**

Authorized 2014 (VISIONIST, VALITUDE)

Products no longer placed on the EU market but continue to be supported. 2013 (INLIVEN, INTUA); 2011 (INVIVE)

