

PHYSICIAN'S LEAD MANUAL

**INGEVITY™ MRI**

Pace/Sense Lead

IS-1 Bipolar Connector

Extendable/Retractable Fixation

Straight

**REF** 7740, 7741, 7742

рсия. Да не се използва.  
erze. Nepoužívajte.  
version. Må ikke anvendes.  
n überholt. Nicht verwenden.  
unud version. Ärge kasutage.

αλιά έκδοση. Μην την χρησιμοποιείτε.  
Outdated version. Do not use.  
Versión obsoleta. No utilizar.  
Version périmée. Ne pas utiliser.

Zastarjela verzija. Nemojte upotrebljavati.  
Úrelt útgáfa. Notið ekki.  
Versione obsolete. Non utilizzare.  
Pasenusi versija. Nenaudokite.  
Elavult verzió. Ne használja!

Dit is een verouderde versie. Niet gebruiken.  
Utdatert versjon. Skal ikke brukes.  
Wersja przeterminowana. Nie używać.  
Versão obsoleta. Não utilize.

Versiune expirată. A nu se utiliza.  
Zastarana verzija. Nepoužívajte.  
Vanhentunut versio. Älä käytä.  
Föråldrad version. Använd  
ancel olmayan sürüm. K

# Table of Contents

|   |           |
|---|-----------|
| <b>INFORMATION FOR USE</b> .....          | <b>1</b>  |
| Device Description .....                  | 1         |
| Related Information .....                 | 2         |
| MR Conditional System Information .....   | 2         |
| Indications and Usage .....               | 3         |
| Contraindications .....                   | 3         |
| Warnings .....                            | 3         |
| Precautions .....                         | 5         |
| Potential Adverse Events .....            | 9         |
| Warranty Information .....                | 10        |
| <b>PRE- IMPLANT INFORMATION</b> .....     | <b>10</b> |
| Surgical Preparation .....                | 11        |
| Items Included .....                      | 11        |
| Accessories .....                         | 11        |
| Vein Pick .....                           | 11        |
| Radiopaque Suture Sleeve .....            | 11        |
| Stylets .....                             | 12        |
| Fixation Tool .....                       | 12        |
| Lead Cap .....                            | 13        |
| <b>IMPLANTATION</b> .....                 | <b>13</b> |
| Inserting the Stylet .....                | 13        |
| Handling the Fixation Helix .....         | 14        |
| Inserting the Lead .....                  | 15        |
| Positioning Lead in Right Atrium .....    | 18        |
| Positioning Lead in Right Ventricle ..... | 19        |
| Lead Fixation .....                       | 20        |
| Checking for Lead Stability .....         | 22        |
| Repositioning the Lead .....              | 22        |
| Evaluating Lead Performance .....         | 23        |
| Securing the Lead .....                   | 24        |
| Connection to a Pulse Generator .....     | 27        |
| Electrical Performance .....              | 27        |
| <b>POSTIMPLANT</b> .....                  | <b>28</b> |
| Postimplant Evaluation .....              | 28        |
| Explantation .....                        | 28        |
| <b>SPECIFICATIONS</b> .....               | <b>29</b> |
| Specifications (Nominal) .....            | 29        |
| Lead Introducer .....                     | 31        |
| Symbols on Packaging .....                | 31        |

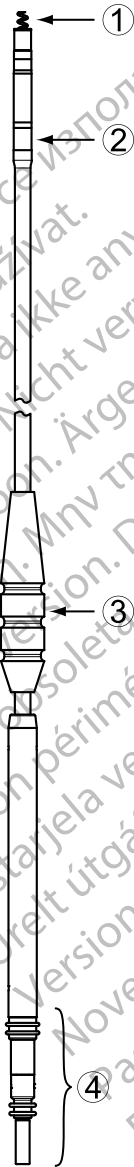

Extendable/retractable fixation,  
isodiametric lead body

1. Cathode
2. Anode
3. Suture Sleeve
4. IS-1 Bipolar Connector

7740, 7741, 7742

---

## INFORMATION FOR USE

### Device Description

This lead family has the following characteristics:

- Endocardial pace/sense lead—intended for chronic bipolar pacing and sensing in the atrium and/or ventricle.
- IS-1 bipolar connector<sup>1</sup>—the industry standard connector to be used in conjunction with a compatible cardiac device that accepts the IS-1 connector.
- MR Conditional—leads can be used as part of the ImageReady MR Conditional Pacing System or the ImageReady MR Conditional Defibrillation System when connected to Boston Scientific MR Conditional pulse generators ("MR Conditional System Information" on page 2).
- IROX-coated electrodes—the electrodes are coated with IROX to increase the microscopic surface area.
- Steroid-eluting—upon exposure to body fluids, the steroid elutes from the lead to help reduce tissue inflammation response at the distal electrode. The steroid suppresses the inflammatory response believed to cause threshold rises typically associated with implanted pacing electrodes. Lower thresholds are desirable because they can increase pacing safety margins and reduce pacing energy requirements, potentially increasing pulse generator longevity. The nominal dose and structure of the steroid are listed in the specifications (Table 5 Specifications (Nominal) on page 29).
- Radiopaque suture sleeve—the radiopaque suture sleeve is visible under fluoroscopy and is used to secure, immobilize, and protect the lead at the venous entry site after lead placement. The window feature is designed to aid compression of the sleeve onto the lead during suturing.
- Extendable/Retractable fixation—the extendable/retractable helix design anchors the distal tip electrode to the endocardial surface without support of trabecular structures, offering various lead placement possibilities for the tip electrode in the right atrium and/or right ventricle. The helix serves as the cathode for endocardial pacing and sensing. The helix is extended and retracted using the fixation tool.
- Fluoroscopic markers—radiopaque markers near the distal tip can be seen under fluoroscopy. These markers show when the helix is fully retracted or fully extended.
- Lead body—the isodiametric lead body consists of a coaxial design that includes single-filar inner and outer coils designed for MR Conditional use in the MRI environment, as well as for improved flexural fatigue. The conductors are separated by both a silicone rubber and Polytetrafluoroethylene (PTFE) lining. Both the inner and outer coil are covered in Ethylene tetrafluoroethylene (ETFE) for extra insulation.

1. IS-1 refers to the international standard ISO 5841-3:2013.

protection. The entire lead body is encompassed in a polyurethane outer insulation.

- Stylet delivery method—the design consists of an open-lumen conductor coil to enable lead delivery using a stylet. Refer to the stylet information ("Stylets" on page 12).

## Related Information

Instructions in the lead manual should be used in conjunction with other resource material, including the applicable pulse generator physician's manual and instructions for use on any implant accessories or tools.

For additional reference information, go to [www.bostonscientific-elabeling.com](http://www.bostonscientific-elabeling.com).

Refer to the ImageReady MR Conditional Pacing System MRI Technical Guide or the ImageReady MR Conditional Defibrillation System MRI Technical Guide<sup>2</sup> (hereafter each referred to as the MRI Technical Guide) for information about MRI scanning.

## INTENDED AUDIENCE

This literature is intended for use by professionals trained or experienced in device implant and/or follow-up procedures.

## MR Conditional System Information

These leads<sup>3</sup> can be used as part of the ImageReady MR Conditional Pacing System or the ImageReady MR Conditional Defibrillation System (hereafter each referred to as an MR Conditional System) when connected to Boston Scientific MR Conditional pulse generators. Patients with an MR Conditional System may be eligible to undergo MRI scans if performed when all Conditions of Use, as defined in the applicable MRI Technical Guide, are met.

Components required for MR Conditional status include specific models of Boston Scientific pulse generators, leads, and accessories; the Programmer/Recorder/Monitor (PRM); and PRM Software Application. For the model numbers of MR Conditional pulse generators and components, as well as a complete description of the ImageReady MR Conditional System, refer to the applicable MRI Technical Guide.

## Implant-related MRI Conditions of Use

The following subset of the MRI Conditions of Use pertains to implantation, and is included as a guide to ensure implantation of a complete ImageReady MR Conditional System. For a full list of Conditions of Use, refer to the MRI Technical Guide. All items on the full list of Conditions of Use must be met in order for an MRI scan to be considered MR Conditional.

- Patient is implanted with the ImageReady MR Conditional Pacing System<sup>4</sup> or the ImageReady MR Conditional Defibrillation System<sup>4</sup>
2. Available at [www.bostonscientific-elabeling.com](http://www.bostonscientific-elabeling.com).
  3. Some marketed INGEVITY MRI leads and all INGEVITY MRI leads used in the SAMURAI clinical study have two radiopaque marker bands on the proximal end.
  4. Defined as a Boston Scientific MR Conditional pulse generator and lead(s), with all ports occupied by a lead or port plug.

- No other active or abandoned implanted devices, components, or accessories present such as lead adaptors, extenders, leads, or pulse generators
- Bipolar pacing operation or pacing off with the ImageReady MR Conditional Pacing System
- Pulse generator implant location restricted to left or right pectoral region
- At least six (6) weeks have elapsed since implantation and/or any lead revision or surgical modification of the MR Conditional System
- Pacing threshold  $\leq 2.0$  V in pace-dependent patients with the ImageReady MR Conditional Pacing System
- No evidence of a fractured lead or compromised pulse generator-lead system integrity

## Indications and Usage

This Boston Scientific lead is indicated for use as follows:

- Intended for chronic pacing and sensing in the right atrium and/or right ventricle when used with a compatible pulse generator

## Contraindications

Use of this Boston Scientific lead is contraindicated for the following patients:

- Patients with a hypersensitivity to a nominal single dose of 0.91 mg dexamethasone acetate
- Patients with mechanical tricuspid heart valves

## WARNINGS

### General

- **Labeling knowledge.** Read this manual thoroughly before implantation to avoid damage to the pulse generator and/or lead. Such damage can result in patient injury or death.
- **For single patient use only.** Do not reuse, reprocess, or resterilize. Reuse, reprocessing, or resterilization may compromise the structural integrity of the device and/or lead to device failure which, in turn, may result in patient injury, illness, or death. Reuse, reprocessing, or resterilization may also create a risk of contamination of the device and/or cause patient infection or cross-infection, including, but not limited to, the transmission of infectious disease(s) from one patient to another. Contamination of the device may lead to injury, illness, or death of the patient.
- **Backup defibrillation protection.** Always have external defibrillation equipment available during implant and electrophysiologic testing. If not terminated in a timely fashion, an induced ventricular tachyarrhythmia can result in the patient's death.

- **Resuscitation availability.** Ensure that an external defibrillator and medical personnel skilled in CPR are present during post-implant device testing should the patient require external rescue.
- **Lead fracture.** Lead fracture, dislodgment, abrasion, or an incomplete connection can cause a periodic or continual loss of pacing or sensing or both.

## Handling

- **Excessive flexing.** Although pliable, the lead is not designed to tolerate excessive flexing, bending, or tension. This could cause structural weakness, conductor discontinuity, and/or lead dislodgment.
- **Do not kink leads.** Do not kink, twist, or braid the lead with other leads as doing so could cause lead insulation abrasion damage or conductor damage.

## Implant Related

- **Do not implant in MRI site Zone III.** Implant of the system cannot be performed in an MRI site Zone III (and higher) as defined by the American College of Radiology Guidance Document for Safe MR Practices<sup>5</sup>. Some of the accessories packaged with pulse generators and leads, including the torque wrench and stylet wires, are not MR Conditional and should not be brought into the MRI scanner room, the control room, or the MRI site Zone III or IV areas.
- **Electrode placement above midseptum.** The safety and efficacy of the tip electrode placement in the right ventricle above midseptum has not been clinically established.
- **Obtain appropriate electrode position.** Take care to obtain appropriate electrode position. Failure to do so may result in suboptimal lead measurements.

## Post-Implant

- **Magnetic Resonance Imaging (MRI) exposure.** Unless all of the MRI Conditions of Use (as described in the MRI Technical Guide) are met, MRI scanning of the patient does not meet MR Conditional requirements for the implanted system, and significant harm to or death of the patient and/or damage to the implanted system may result.

Refer to the MRI Technical Guide for potential adverse events applicable when Conditions of Use are met or not met, as well as for a complete list of MRI-related Warnings and Precautions.

- **Diathermy.** Do not subject a patient with an implanted pulse generator and/or lead to diathermy since diathermy may cause fibrillation, burning of the myocardium, and irreversible damage to the pulse generator because of induced currents.

5. Kanal E, et al., American Journal of Roentgenology 188:1447-74, 2007.



# PRECAUTIONS

## Clinical Considerations

- **Dexamethasone acetate.** It has not been determined whether the warnings, precautions, or complications usually associated with injectable dexamethasone acetate apply to the use of a low concentration, highly localized, controlled-release device. Refer to the Physicians' Desk Reference™<sup>6</sup> for a listing of potentially adverse effects.

## Sterilization and Storage

- **If package is damaged.** The blister trays and contents are sterilized with ethylene oxide gas before final packaging. When the pulse generator and/or lead is received, it is sterile provided the container is intact. If the packaging is wet, punctured, opened, or otherwise damaged, return the pulse generator and/or lead to Boston Scientific.
- **Storage temperature.** Store at 25°C (77°F). Excursions are permitted between 15°C to 30°C (59°F to 86°F). Transportation spikes are permitted up to 50°C (122°F).
- **Use by date.** Implant the pulse generator and/or lead before or on the USE BY date on the package label because this date reflects a validated shelf life. For example, if the date is January 1, do not implant on or after January 2.

## Handling

- **Do not immerse in fluid.** Do not wipe or immerse the tip electrode in fluid. Such treatment will reduce the amount of steroid available when the lead is implanted.
- **Chronic repositioning.** Optimum threshold performance might not be achieved if the lead is chronically repositioned because the steroid can be depleted.
- **Protect from surface contamination.** The lead uses silicone rubber which can attract particulate matter, and therefore, must always be protected from surface contamination.
- **Do not alter or use deformed helix.** To promote proper function do not use a lead with a deformed helix or damaged helix fixation mechanism. To avoid electrode damage, do not attempt to straighten or realign the helix. Avoid holding or handling the distal tip.
- **No mineral oil on lead tip.** Mineral oil should never come in contact with the helix. Mineral oil on the helix may inhibit tissue ingrowth and conduction.
- **Ensure suture sleeve position.** Ensure the suture sleeve remains proximal to the venous entry site and near the terminal boot molding throughout the procedure until it is time to secure the lead.

6. Physicians' Desk Reference is a trademark of Thomson Healthcare Inc.

## Implantation

- **Evaluate patient for surgery.** There may be additional factors regarding the patient's overall health and medical condition that, while not related to device function or purpose, could render the patient a poor candidate for implantation of this system. Cardiac health advocacy groups may have published guidelines that may be helpful in conducting this evaluation.
- **Lead compatibility.** Prior to implantation, confirm the lead-to-pulse generator compatibility. Using incompatible leads and pulse generators can damage the connector and/or result in potential adverse consequences, such as undersensing of cardiac activity or failure to deliver necessary therapy.
- **Use recommended stylet.** It is recommended that you use a stylet designed for use with this lead.
- **Line-powered equipment.** Exercise extreme caution if testing leads using line-powered equipment because leakage current exceeding 10  $\mu\text{A}$  can induce ventricular fibrillation. Ensure that any line-powered equipment is within specifications.
- **Do not bend the lead near the lead-header interface.** Insert the lead terminal straight into the lead port. Do not bend the lead near the lead-header interface. Improper insertion can cause insulation or connector damage.
- **Vein pick.** The vein pick is not intended either for puncturing the vein or for dissecting tissue during a cutdown procedure. Be sure that the vein pick does not puncture the insulation of the lead. This could prevent proper lead function.
- **Do not bend lead with stylet in place.** Do not bend the lead with a stylet in place. Bending the lead could damage the conductor and insulation material.
- **Tools applied to distal end.** Do not apply tools to the distal end of the lead because lead damage could occur. Avoid holding or handling the distal tip of the lead.
- **Curving the stylet.** Do not use a sharp object to curve the distal end of a stylet. Do not curve a stylet while it is in the lead. If a curved stylet is preferred, gently curve a straight stylet before inserting it into the lead to avoid damage to the stylet and lead.
- **Do not overextend or over-retract the helix.** Do not overextend or over-retract the helix. The lead conductor coil or fixation mechanism can be damaged or broken if you continue to rotate the terminal pin once the helix is fully extended or retracted.
- **Avoid creating sharp bends while extending or retracting helix.** Avoid creating sharp bends in the lead terminal or lead body while extending or retracting the helix. Sharp bends can increase the risk of breaking the conductor coil or fixation mechanism during helix extension and retraction.
- **Terminal pin maximum number of turns.** Do not rotate the terminal pin clockwise or counterclockwise more than the recommended maximum

number of turns indicated in the specifications (Table 5 Specifications (Nominal) on page 29). Continuing to rotate the terminal pin once the helix is fully extended or retracted (as indicated by fluoroscopy) can damage the lead, cause a conductor coil break during fixation, cause lead dislodgment, tissue trauma, and/or cause acute pacing threshold to rise.

- **Ensure helix is retracted.** Do not insert a lead into the vein when the helix is extended, as this may cause damage to the tissue and/or lead. Prior to insertion in the vein, rotate the terminal pin counterclockwise to retract the helix into the distal lead tip.
- **Helix retraction during implant.** Do not continue to use the lead if the helix cannot be retracted during implant. Continuous counterclockwise rotation of the lead body during lead removal is necessary to avoid inadvertent tissue trauma and accidental fixation, and to release the electrode helix if tissue snagging has occurred.
- **Do not implant lead under clavicle.** When attempting to implant the lead via a subclavian puncture, do not introduce the lead under the medial one-third region of the clavicle. Damage or chronic dislodgment to the lead is possible if the lead is implanted in this manner. If implantation via the subclavian vein is desired, the lead must enter the subclavian vein near the lateral border of the first rib to avoid entrapment by the subclavius muscle or ligamentous structures associated with the narrow costoclavicular region. It has been established in the literature that lead fracture can be caused by lead entrapment in such soft tissue structures as the subclavius muscle, costocoracoid ligament, or the costoclavicular ligament.<sup>7</sup>
- **Thin apical wall.** If the patient has a thin apical wall, another fixation site should be considered.
- **Lead dislodgment.** Should dislodgment occur, immediate medical care is required to resolve the electrode position and minimize endocardial trauma.
- **Prevent dislodgment.** To prevent dislodgment, avoid rotating the terminal pin after fixating the lead.
- **Compatible delivery tools.** Only use compatible delivery tools to deliver the lead because using incompatible delivery tools may cause lead damage or patient injury.
- **Avoid tight stricture.** When ligating the vein, avoid stricture that is too tight. A tight stricture might damage the insulation or sever the vein. Avoid dislodging the distal tip during the anchoring procedure.
- **Do not suture directly over lead.** Do not suture directly over the lead body, as this may cause structural damage. Use the suture sleeve to secure the lead proximal to the venous entry site to prevent lead movement.

7. Magney JE, et al. Anatomical mechanisms explaining damage to pacemaker leads, defibrillator leads, and failure of central venous catheters adjacent to the sternoclavicular joint. PACE, 1993;16:445–457.

- **Use caution to remove suture sleeve.** Avoid removing or cutting the suture sleeve from the lead. If removal of the suture sleeve is necessary, use caution as lead damage can occur.
- **Use of multiple suture sleeves has not been evaluated.** Use of multiple suture sleeves has not been evaluated and is not recommended.

## Hospital and Medical Environments

- **Electrocautery.** Electrocautery may induce ventricular arrhythmias and/or fibrillation, and may cause asynchronous pacing, inhibition of pacing, and/or a reduction in pulse generator pacing output possibly leading to loss of capture.

If electrocautery is medically necessary, observe the following to minimize risk to the lead. Also, refer to pulse generator labeling for device programming recommendations and additional information about minimizing risk to the patient and system.

- Avoid direct contact between the electrocautery equipment and the pulse generator or leads.
- Keep the path of the electrical current as far away as possible from the pulse generator and leads.
- If electrocautery is performed on tissue near the device or leads, monitor pre- and post- measurements for sensing and pacing thresholds and impedances to determine the integrity and stability of the system.
- Use short, intermittent, and irregular bursts at the lowest feasible energy levels.
- Use a bipolar electrocautery system where possible.

• **Radio frequency (RF) ablation.** RF ablation may induce ventricular arrhythmias and/or fibrillation, and may cause asynchronous pacing, inhibition of pacing, and/or a reduction in pulse generator pacing output possibly leading to loss of capture. RF ablation may also cause ventricular pacing up to the Maximum Tracking Rate (MTR) and/or changes in pacing thresholds. Additionally, exercise caution when performing any other type of cardiac ablation procedure in patients with implanted devices.

If RF ablation is medically necessary, observe the following to minimize risk to the lead. Also, refer to pulse generator labeling for device programming recommendations and additional information about minimizing risk to the patient and system.

- Avoid direct contact between the ablation catheter and the pulse generator and leads. RF ablation close to the lead electrode may damage the lead-tissue interface.
- Keep the path of the electrical current as far away as possible from the pulse generator and leads.
- If RF ablation is performed on tissue near the device or leads, monitor pre- and post-measurements for sensing and pacing thresholds and impedances to determine the integrity and stability of the system.

- **Central line guidewire insertion.** Use caution when inserting guidewires for placement of other types of central venous catheter systems such as PIC lines or Hickman catheters in locations where pulse generator leads may be encountered. Insertion of such guidewires into veins containing leads could result in the leads being damaged or dislodged.

## Follow-up Testing

- **Lead performance in chronic state.** For some patients, lead performance at implant may not predict performance in the chronic state. Therefore, it is recommended that post-implant lead evaluation follow-up be done at the routine pulse generator follow-up and additionally as necessary.

## Potential Adverse Events

Based on the literature and on pulse generator and/or lead implant experience, the following list includes the possible adverse events associated with implantation of products described in this literature:

- Air embolism
- Allergic reaction
- Arterial damage with subsequent stenosis
- Bleeding
- Bradycardia
- Breakage/failure of the implant instruments
- Cardiac perforation
- Cardiac tamponade
- Chronic nerve damage
- Component failure
- Conductor coil fracture
- Death
- Electrolyte imbalance/dehydration
- Elevated thresholds
- Erosion
- Excessive fibrotic tissue growth
- Extracardiac stimulation (muscle/nerve stimulation)
- Fluid accumulation
- Foreign body rejection phenomena
- Formation of hematomas or seromas
- Heart block
- Hemorrhage
- Hemothorax

- Inability to pace
- Inappropriate therapy (e.g., shocks and antitachycardia pacing [ATP] where applicable, pacing)
- Incisional pain
- Incomplete lead connection with pulse generator
- Infection including endocarditis
- Lead dislodgment
- Lead fracture
- Lead insulation breakage or abrasion
- Lead tip deformation and/or breakage
- Malignancy or skin burn due to fluoroscopic radiation
- Myocardial trauma (e.g., tissue damage, valve damage)
- Myopotential sensing
- Oversensing/undersensing
- Pericardial rub, effusion
- Pneumothorax
- Pulse generator and/or lead migration
- Syncope
- Tachyarrhythmias, which include acceleration of arrhythmias and early, recurrent atrial fibrillation
- Thrombosis/thromboemboli
- Valve damage
- Vasovagal response
- Venous occlusion
- Venous trauma (e.g., perforation, dissection, erosion)

For a list of potential adverse events associated with MRI scanning, refer to the appropriate ImageReady MR Conditional Pacing System or Defibrillation System MRI Technical Guide.

## Warranty Information

A limited warranty certificate for the lead is available. For a copy, contact Boston Scientific using the information on the back cover.

## PRE- IMPLANT INFORMATION

Proper surgical procedures and techniques are the responsibility of the medical professional. The described implant procedures are furnished only for informational purposes. Each physician must apply the information in these instructions according to professional medical training and experience.

The lead is designed, sold, and intended for use only as indicated.

## Surgical Preparation

Consider the following prior to the implantation procedure:

- Instrumentation for cardiac monitoring, imaging (fluoroscopy), external defibrillation, and lead signal measurements must be available during implant.
- Always isolate the patient from potentially hazardous leakage current when using electrical instrumentation.
- Sterile duplicates of all implantable items should be available for use if accidental damage or contamination occurs.

## Items Included

The following items are packaged with the lead:

Vein pick

Stylets

Stylet guide

Fixation tools

Literature

## Accessories

Separately packaged lead accessories are available in addition to those packaged with the lead.

### Vein Pick

The vein pick is a disposable plastic device designed to assist with insertion into a vein during a cutdown procedure.

### Radiopaque Suture Sleeve

The radiopaque suture sleeve is an adjustable, tubular reinforcement that is visible under fluoroscopy. It is positioned over the outer lead insulation and is designed to secure and protect the lead at the venous entry site after lead placement. Using a suture sleeve reduces the possibility of structural damage caused by suturing directly over the lead body. To move the suture sleeve, gently pinch and slide it over the lead until it is in the desired position. The window feature is designed to aid compression of the sleeve onto the lead during suturing.

**NOTE:** A radiopaque suture sleeve is pre-loaded on the lead and is also available in a slit form as an accessory (Model 6402). The accessory slit suture sleeve is intended to be used as a replacement for the pre-loaded suture sleeve in the event of damage or loss.

**CAUTION:** Use of multiple suture sleeves has not been evaluated and is not recommended.

## Stylets

Stylets aid in positioning the lead. Ensure you use the length appropriate to the lead. Stylets of various degrees of stiffness are available depending on implant technique and patient anatomy.

**Table 1. Stylet lengths and stiffness**

| Lead Model Number (Type) | Length (cm) (imprinted on cap of the stylet knob) | Recommended Stylet Model Number (Type) | Stylet Stiffness and Knob Color | Stylet Cap Color |
|--------------------------|---|--|---------------------------------|------------------|
| 7740 (Straight)          | 45  | 5012 (Long Tapered)                    | Soft = Green                    | White            |
|                          |   | 5003 (Straight)                        | X-Soft = Yellow                 |                  |
|                          |   | 6053 (Wide Atrial J)                   | Soft = Green                    |                  |
|                          |   | 6506 (Atrial J)                        | Soft = Green                    |                  |
| 7741 (Straight)          | 52  | 5013 (Long Tapered)                    | Soft = Green                    | Red              |
|                          |   | 5004 (Straight)                        | X-Soft = Yellow                 |                  |
|                          |   | 6054 (Wide Atrial J)                   | Soft = Green                    |                  |
|                          |   | 6586 (Atrial J)                        | Soft = Green                    |                  |
| 7742 (Straight)          | 59  | 5014 (Long Tapered)                    | Soft = Green                    | Yellow           |
|                          |   | 5005 (Straight)                        | X-Soft = Yellow                 |                  |
|                          |   | 6055 (Wide Atrial J) <sup>a</sup>      | Soft = Green                    |                  |
|                          |   | 6603 (Atrial J) <sup>a</sup>           | Soft = Green                    |                  |

a. Stylet model available as accessory item only.

**CAUTION:** It is recommended that you use a stylet designed for use with this lead.

## Fixation Tool

The fixation tool can be attached to the terminal pin and rotated clockwise for extension or counterclockwise for retraction of the helix (Figure 1. Fixation tool on page 13).



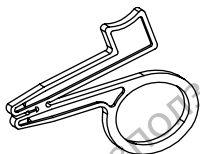

Figure 1. Fixation tool

### Lead Cap

The lead cap may be used to isolate or cap the lead terminal that is not inserted in the pulse generator. Place a suture around the lead cap groove to secure the lead cap to the lead terminal. Use an appropriate cap for lead.

---

## IMPLANTATION

**NOTE:** Select the appropriate lead length for a given patient. It is important to select a lead that is long enough to avoid any sharp angles or kinks and to allow for a gentle curve of excess lead in the pocket. Typically, a minimum of 5 to 10 cm of excess lead is sufficient to achieve this configuration in the pocket.

**NOTE:** Refer to the appropriate ImageReady MR Conditional Pacing System or Defibrillation System MRI Technical Guide for considerations affecting choice and implant of leads for use as part of an MR Conditional system. Use of Boston Scientific MR Conditional pulse generators and leads is required for an implanted system to be considered MR Conditional. Refer to the appropriate ImageReady MR Conditional Pacing System or Defibrillation System MRI Technical Guide for model numbers of pulse generators, leads, accessories, and other system components needed to satisfy the Conditions of Use for MR Conditional scanning.

**NOTE:** Other implanted devices or patient conditions may cause a patient to be ineligible for an MRI scan, independent of the status of the patient's ImageReady MR Conditional System.

### Inserting the Stylet

Follow the steps below to insert a stylet.

1. Remove any preinserted stylet before inserting a different one.
2. Select a stylet according to the function and to the preferred firmness. If desired, gently curve the stylet with any sterile, smooth-surfaced instrument (e.g., 10-cc or 12-cc syringe barrel) (Figure 2 Curve the stylet on page 14).

**CAUTION:** Do not use a sharp object to curve the distal end of a stylet. Do not curve a stylet while it is in the lead. If a curved stylet is preferred, gently curve a straight stylet before inserting it into the lead to avoid damage to the stylet and lead.

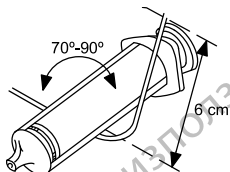

**Figure 2. Curve the stylet**

3. Insert the chosen stylet through the terminal pin or the stylet guide if using one (Figure 3 Insert the stylet on page 14).

**NOTE:** To optimize insertion into the lead, do not allow body fluids to come in contact with the stylet.

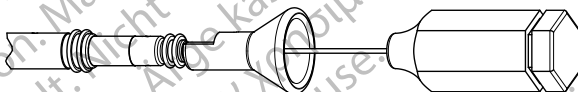

**Figure 3. Insert the stylet**

4. Ensure the stylet is fully inserted in the lead prior to inserting the lead into the vein.

**CAUTION:** Do not bend the lead with a stylet in place. Bending the lead could damage the conductor and insulation material.

## Handling the Fixation Helix

Before implanting the lead, verify the mechanical functioning of the lead.

1. Grasp the fixation tool and lead terminal. To engage the fixation tool, press the handles together and place the pin of the lead in the preformed groove. Release the tension on the handles to secure the terminal pin in the fixation tool.

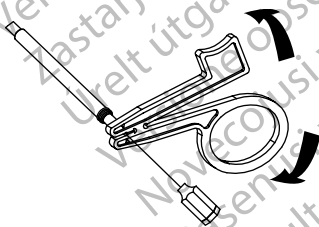

**Figure 4. Fixation tool attached**

2. Slowly rotate the terminal pin clockwise (approximately 1 rotation per second) to extend the helix and counterclockwise to retract it and visually observe the helix extending and retracting.

**NOTE:** The expected number of turns and the recommended maximum number of turns to extend or retract the helix are provided in the specifications (Table 5 Specifications (Nominal) on page 29). Any curves introduced into the stylet could increase the number of turns needed to extend or retract the helix.

**CAUTION:** Do not overextend or over-retract the helix. The lead conductor coil or fixation mechanism can be damaged or broken if you continue to rotate the terminal pin once the helix is fully extended or retracted.

**CAUTION:** If the helix cannot be extended or retracted, do not use the lead.

**CAUTION:** To promote proper function do not use a lead with a deformed helix or damaged helix fixation mechanism. To avoid electrode damage, do not attempt to straighten or realign the helix. Avoid holding or handling the distal tip.

**CAUTION:** Avoid creating sharp bends in the lead terminal or lead body while extending or retracting the helix. Sharp bends can increase the risk of breaking the conductor coil or fixation mechanism during helix extension and retraction.

3. Ensure the helix is retracted into the distal lead tip prior to inserting the lead into the vein.

**CAUTION:** Do not insert a lead into the vein when the helix is extended, as this may cause damage to the tissue and/or lead. Prior to insertion in the vein, rotate the terminal pin counterclockwise to retract the helix into the distal lead tip.

4. Disengage the fixation tool from the terminal pin prior to inserting the lead into the vein.

## Inserting the Lead

The lead may be inserted using one of the following methods: via the cephalic vein, or through the subclavian or internal jugular vein.

- **Via cutdown through the left or right cephalic vein** Only one incision over the deltopectoral groove is required to access the right or left cephalic vein in the deltopectoral groove.

The vein pick packaged with this lead can be used to aid access during the cutdown procedure. Isolate the selected vein and introduce the point of the vein pick via this incision into the lumen of the vein. With the point of the vein pick facing in the direction of the desired lead passage, gently raise and tilt the pick. Pass the lead under the vein pick and into the vein.

**CAUTION:** The vein pick is not intended either for puncturing the vein or for dissecting tissue during a cutdown procedure. Be sure that the vein pick does not puncture the insulation of the lead. This could prevent proper lead function.



Figure 5. Using the vein pick

**Percutaneously or via cutdown through the subclavian vein** A subclavian introducer set is available for use during percutaneous lead insertion. Refer to the specifications for the recommended introducer size.

**CAUTION:** When attempting to implant the lead via a subclavian puncture, do not introduce the lead under the medial one-third region of the clavicle. Damage or chronic dislodgment to the lead is possible if the lead is implanted in this manner. If implantation via the subclavian vein is desired, the lead must enter the subclavian vein near the lateral border of the first rib to avoid entrapment by the subclavius muscle or ligamentous structures associated with the narrow costoclavicular region. It has been established in the literature that lead fracture can be caused by lead entrapment in such soft tissue structures as the subclavius muscle, costocoracoid ligament, or the costoclavicular ligament.<sup>8</sup>

Leads placed by percutaneous subclavian venipuncture should enter the subclavian vein, where it passes over the first rib (rather than more medially), to avoid entrapment by the subclavius muscle or ligamentous structures associated with the narrow costoclavicular region.<sup>9</sup> It is recommended to introduce the lead into the subclavian vein near the lateral border of the first rib.

The syringe should be positioned directly above and parallel to the axillary vein to reduce the chance that the needle will contact the axillary or subclavian arteries or the brachial plexus. Use of fluoroscopy is helpful in locating the first rib and in guiding the needle.

The steps below explain how to identify the skin entry point and define the course of the needle toward the subclavian vein where it crosses the first rib.

1. Identify points St (sternal angle) and Cp (coracoid process) (Figure 6 Entry point for percutaneous subclavian venipuncture on page 17).

8. Magney JE, et al. Anatomical mechanisms explaining damage to pacemaker leads, defibrillator leads, and failure of central venous catheters adjacent to the sternoclavicular joint. *PACE*. 1993;16:445–457.
9. Magney JE, et al. A new approach to percutaneous subclavian venipuncture to avoid lead fracture or central venous catheter occlusion. *PACE*. 1993;16:2133–2142.

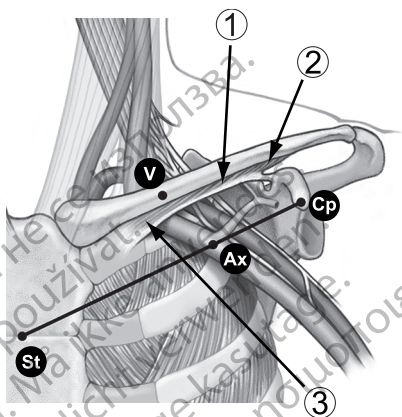

[1] Subclavius muscle [2] Costocoracoid ligament [3] Costoclavicular ligament

**Figure 6. Entry point for percutaneous subclavian venipuncture**

2. Visually draw a line between St and Cp, and divide the segment into thirds. The needle should pierce the skin at the junction of the middle and lateral thirds, directly above the axillary vein (point Ax).
3. Place an index finger on the clavicle at the junction of the medial and middle thirds (point V), beneath which point the subclavian vein should be located.
4. Press a thumb against the index finger and project 1–2 centimeters below the clavicle to shield the subclavius muscle from the needle (when hypertrophy of the pectoralis muscle is apparent, the thumb should project about 2 centimeters below the clavicle because the subclavius muscle should be hypertrophied as well) (Figure 7). Location of thumb and needle entry on page 17).

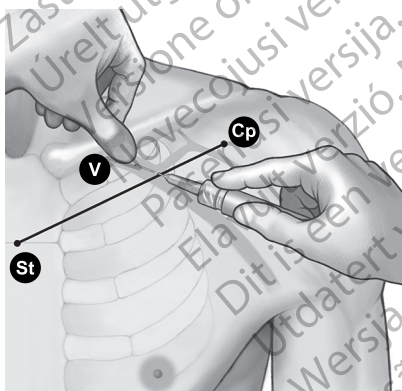

**Figure 7. Location of thumb and needle entry**

5. Feel with the thumb the pressure from the passage of the needle through the superficial fascia; direct the needle deep into the tissues toward the subclavian vein and the underlying first rib. Fluoroscopic guidance will reduce the chance that the needle would pass below the first rib and into the lung.

## Positioning Lead in Right Atrium

Two different J-shape stylets are provided. One has a longer reach and may be suitable for most patient anatomies. The smaller stylet may be more suitable for a patient with a smaller atrium or a patient who has had previous cardiac surgery.

Correct functioning of the lead depends on appropriate placement of the electrodes. Follow the instructions below to position the lead.

1. Ensure the helix is retracted.

**CAUTION:** Do not insert a lead into the vein when the helix is extended, as this may cause damage to the tissue and/or lead. Prior to insertion in the vein, rotate the terminal pin counterclockwise to retract the helix into the distal lead tip.

2. Use a straight stylet to advance the lead into the right atrium.
3. With the lead low in the right atrium, withdraw the straight stylet and insert a J-shaped or a curved straight stylet.
4. Gently pull the lead/stylet combination at the venous entry site to ensure contact between the lead tip and the endocardium. A satisfactory position has the lead tip situated against the endocardium in the atrium (Figure 8 Atrial placement on page 19).
5. After placing the lead, extend the helix as described in the Lead Fixation section ("Lead Fixation" on page 20).

**WARNING:** Take care to obtain appropriate electrode position. Failure to do so may result in suboptimal lead measurements.

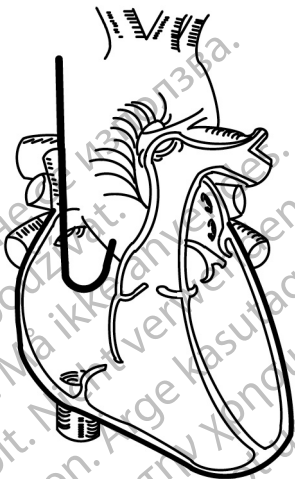

**Figure 8. Atrial placement**

## Positioning Lead in Right Ventricle

Correct functioning of the lead depends on appropriate placement of the electrodes. Follow the instructions below to position the lead.

1. Ensure the helix is retracted.

**CAUTION:** Do not insert a lead into the vein when the helix is extended, as this may cause damage to the tissue and/or lead. Prior to insertion in the vein, rotate the terminal pin counterclockwise to retract the helix into the distal lead tip.

2. Partially withdraw the stylet to utilize the flexible silicone neck during lead positioning. Withdrawal of the stylet tip proximal to the anode minimizes tip stiffness and provides added flexibility of the tip region.
3. Advance the lead into the right atrium using a straight stylet.
4. Advance the lead through the tricuspid valve or place the lead tip against the lateral atrial wall and back the curved lead body through the tricuspid valve.

**NOTE:** A curved stylet may enhance maneuverability.

5. Under fluoroscopy and with a stylet in the lead, advance the lead as far as possible so the tip electrode is in healthy myocardium in the apex of the right ventricle.

**WARNING:** Take care to obtain appropriate electrode position. Failure to do so may result in suboptimal lead measurements.

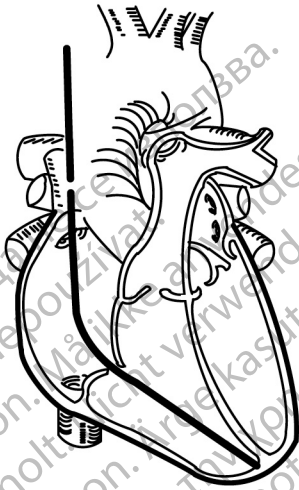

**Figure 9. Ventricular placement**

6. Verify under fluoroscopy that the distal tip electrode is situated in the right ventricle.

**CAUTION:** If the patient has a thin apical wall, another fixation site should be considered.

## Lead Fixation

The lead helix is electrically conductive to allow mapping (measuring pacing and sensing thresholds) of potential electrode positions without extending the helix into the tissue. Mapping prior to lead fixation is recommended as it can reduce the potential need for multiple lead positionings.

When data are acceptable and the correct position has been achieved, proceed with lead fixation.

**NOTE:** *Maintain the stylet in a partially retracted position when placing the lead in the RV apex or RV free wall to minimize tip stiffness.*

1. Attach the fixation tool to the terminal pin as indicated in the steps below.
  - a. Press the handles together and place the pin in the preformed groove.
  - b. Release the tension on the handles to secure the terminal pin in the fixation tool.



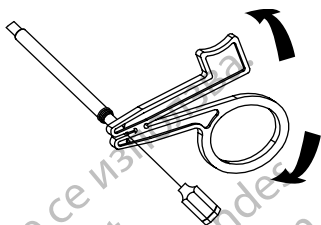

**Figure 10. Fixation tool attached**

2. Apply adequate pressure to the lead body to position the distal electrode against the desired fixation site.
3. Slowly rotate the fixation tool clockwise (approximately 1 rotation per second) to extend and affix the distal electrode helix into the heart wall.

**NOTE:** *Styilet curvature, extended implant time, and repositioning the lead multiple times may increase the number of turns to extend or retract the helix.*

**NOTE:** *The number of turns to extend or retract the helix may vary based on patient anatomy and implant conditions. Maintain a straight trajectory coming out of the patient anatomy to the extent feasible.*

**CAUTION:** Avoid creating sharp bends in the lead terminal or lead body while extending or retracting the helix. Sharp bends can increase the risk of breaking the conductor coil or fixation mechanism during helix extension and retraction.

**CAUTION:** Do not rotate the terminal pin clockwise or counterclockwise more than the recommended maximum number of turns indicated in the specifications (Table 5 Specifications (Nominal) on page 29). Continuing to rotate the terminal pin once the helix is fully extended or retracted (as indicated by fluoroscopy) can damage the lead, cause a conductor coil break during fixation, cause lead dislodgment, tissue trauma, and/or cause acute pacing threshold to rise.

4. View the radiopaque markers under fluoroscopy to identify when the fixation helix is fully extended. Full extension is achieved when the radiopaque markers are joined and the fixation helix is extended outside the distal fluoroscopy markers (Table 2 Fluoroscopic view of helix electrode on page 21).

**Table 2. Fluoroscopic view of helix electrode**

| Fully Retracted | Fully Extended |
|-----------------|----------------|
|                 |                |

5. Once the lead is affixed in the desired location, loosely hold the proximal end of the lead and remove the fixation tool from the terminal pin by pressing the handles together.

**NOTE:** *Upon release of the tool, minimal counter-rotation in the terminal pin may be observed.*

## Checking for Lead Stability

Follow these steps to check lead stability:

1. After fixation, partially withdraw the stylet 8 to 10 cm. (Also see step 5 in this list.)

**CAUTION:** To prevent dislodgment, avoid rotating the terminal pin after fixing the lead.

2. Check the stability of the lead using fluoroscopy. Do not tug on the lead. If possible, have the patient cough or take several deep breaths.
3. For atrial implantation, after the lead tip is affixed to the heart wall, check for proper lead movement and lead slack in the atrium:
  - As the patient exhales, the lead J-shape should appear secure in the atrial appendage.
  - As the patient inhales, the J-shape straightens to form an L-shape. Sufficient slack is present if the lead assumes an L-shape. Excessive slack is present if the lead drops near the tricuspid valve.
4. For ventricular implantation, after the lead tip is affixed to the heart wall, check for proper lead movement and lead slack in the ventricle.
5. When the electrode position is satisfactory, withdraw the stylet.

**CAUTION:** Should dislodgment occur, immediate medical care is required to resolve the electrode position and minimize endocardial trauma.

## Repositioning the Lead

If the lead needs repositioning, follow these steps.

1. Reconnect the fixation tool and rotate the tool counterclockwise to retract the helix.
2. View the radiopaque markers under fluoroscopy to verify that the helix is retracted and disengaged completely from the heart wall before attempting to reposition the lead.

**CAUTION:** Do not rotate the terminal pin clockwise or counterclockwise more than the recommended maximum number of turns indicated in the specifications (Table 5 Specifications (Nominal) on page 29). Continuing to rotate the terminal pin once the helix is fully extended or retracted (as indicated by fluoroscopy) can damage the lead, cause a conductor coil break during fixation, cause lead dislodgment, tissue trauma, and/or cause acute pacing threshold to rise.

**CAUTION:** Do not continue to use the lead if the helix cannot be retracted during implant. Continuous counterclockwise rotation of the lead body during lead removal is necessary to avoid inadvertent tissue trauma and accidental fixation, and to release the electrode helix if tissue snagging has occurred.

3. Reaffix the electrode using the previous procedures for handling, positioning, and checking for lead stability.

## Evaluating Lead Performance

Verify electrical performance of the lead using a pacing system analyzer (PSA) before attaching the lead to the pulse generator. Verifying electrical performance will confirm lead integrity.

1. When the lead is placed in the desired location, partially withdraw the stylet so the terminal pin is accessible.
2. Connect the lead to the PSA.
  - For bipolar leads, the lead terminal pin is the cathode (–) conductor and should be connected to the negative conductor of the PSA patient cable. The ring of the lead terminal is the anode (+) conductor and should be connected to the positive conductor of the patient cable.
3. Perform the measurements as indicated in the table.

**Table 3. Recommended threshold and sensing measurements**

| Measurements                                      | Atrial Data       | Ventricular Data  |
|---|-------------------|-------------------|
| Voltage threshold (pulse width setting at 0.5 ms) | $\leq 1.5$ V      | $\leq 1.0$ V      |
| P-wave / R-wave                                   | $\geq 2.0$ mV     | $\geq 5.0$ mV     |
| Impedance   | 200–2000 $\Omega$ | 200–2000 $\Omega$ |

- Pulse generator measurements may not exactly correlate to the PSA measurements due to signal filtering. Baseline measurements should fall within the recommended values indicated in the table.
  - Lower intrinsic potentials, longer durations, and higher pacing threshold may indicate lead placement in ischemic or scarred tissue. Because signal quality may deteriorate, reposition the lead if necessary to obtain a signal with the largest possible amplitude, shortest duration, and lowest pacing threshold.
4. If measurements do not conform to the values in the table, perform the following steps:
    - Remove the PSA from the lead.
    - Reinsert the stylet and reposition the lead using the procedures previously discussed and repeat the lead evaluation process.
    - If testing results are unsatisfactory, further lead system repositioning or replacement may be required.

Consider the following information:

- Low stimulation threshold readings indicate a desirable safety margin, since stimulation threshold may rise after implantation.
- Initial electrical measurements may deviate from recommendations because of acute cellular trauma. If this occurs, wait approximately 10 minutes and repeat testing. Values may be dependent on patient-

specific factors such as tissue condition, electrolyte balance, and drug interactions.

- Amplitude and duration measurements are not inclusive of current of injury and are taken during the patient's normal baseline rhythm.
  - Over-rotation of the terminal pin may increase local tissue trauma and cause temporarily high voltage thresholds.
5. Test for diaphragmatic stimulation by pacing the lead at a high voltage output, using professional medical judgment to select the output voltage. Adjust the lead configurations and lead position as necessary. PSA testing at higher outputs may also be considered to better characterize stimulation margins. Testing should be conducted for all lead placements.
  6. Once acceptable measurements are obtained, remove the pacing system analyzer connections, and remove the stylet.

## Securing the Lead

After the electrodes are satisfactorily positioned, use the suture sleeve to secure the lead to achieve permanent hemostasis and lead stabilization. Suture sleeve tie-down techniques can vary with the lead insertion technique used. Consider the following warning and precautions while securing the lead.

**WARNING:** Do not kink, twist, or braid the lead with other leads as doing so could cause lead insulation abrasion damage or conductor damage.

**CAUTION:** When ligating the vein, avoid stricture that is too tight. A tight stricture might damage the insulation or sever the vein. Avoid dislodging the distal tip during the anchoring procedure.

**CAUTION:** Do not suture directly over the lead body, as this may cause structural damage. Use the suture sleeve to secure the lead proximal to the venous entry site to prevent lead movement.

**CAUTION:** Avoid removing or cutting the suture sleeve from the lead. If removal of the suture sleeve is necessary, use caution as lead damage can occur.

**CAUTION:** Use of multiple suture sleeves has not been evaluated and is not recommended.

## Percutaneous Implant Technique

1. Peel back the introducer sheath and slide the suture sleeve deep into the tissue (Figure 11 Example of suture sleeve, percutaneous implant technique on page 25).

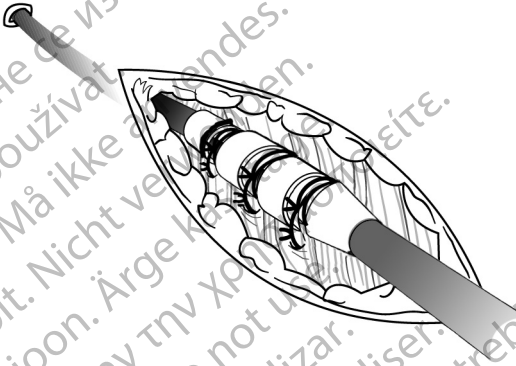
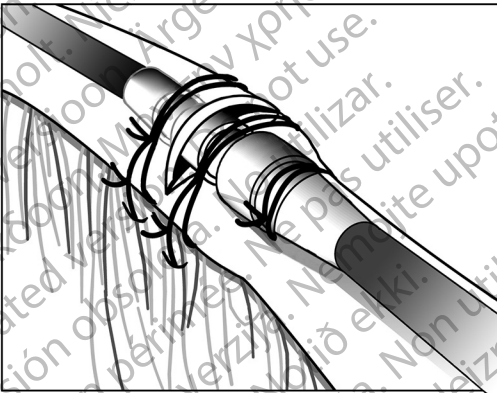

Figure 11. Example of suture sleeve, percutaneous implant technique

2. Using at least two grooves, ligate the suture sleeve and the lead to the fascia. For additional stability, the sleeve may be secured to the lead first before securing the sleeve to the fascia.
3. Check the suture sleeve after tie-down to demonstrate stability and lack of slippage by grasping the suture sleeve with fingers and trying to move the lead in either direction.

### **Venous Cutdown Technique**

1. Slide the suture sleeve into the vein past the distal groove.
2. Ligate the vein around the suture sleeve to obtain hemostasis.
3. Using the same groove, secure the lead and vein to the adjacent fascia (Figure 12 Example of suture sleeve, venous cutdown technique on page 26).



**Figure 12. Example of suture sleeve, venous cutdown technique**

4. Use at least two grooves to secure the sleeve to the lead. Secure the lead and suture sleeve to the adjacent fascia.
5. Check the suture sleeve after tie-down to demonstrate stability and lack of slippage by grasping the suture sleeve with fingers and trying to move the lead in either direction.

## Connection to a Pulse Generator

Consult the applicable pulse generator physician's manual for more instructions for connecting lead terminals to the pulse generator.

1. Verify the stylet and any terminal pin accessories are removed prior to connecting the lead to the pulse generator.
2. When the lead is secured at the venous entry site, recheck position and threshold measurements and then connect the lead to the pulse generator using the procedure described in the applicable pulse generator physician's manual.
3. Grasp the terminal immediately distal to the terminal ring contacts and fully insert the lead terminal into the pulse generator port until the terminal pin is visible beyond the setscrew block. If the terminal pin is difficult to insert, verify the setscrew is completely retracted.

**NOTE:** *If necessary, lubricate the lead connectors sparingly with sterile water to make insertion easier.*

4. Apply gentle traction to the lead by grasping the labeled area of the lead body to ensure a secure connection.

**CAUTION:** - Insert the lead terminal straight into the lead port. Do not bend the lead near the lead-header interface. Improper insertion can cause insulation or connector damage.

**NOTE:** *If the lead terminal will not be connected to a pulse generator at the time of lead implantation, you must cap the connector before closing the pocket incision. The lead cap is designed specifically for this purpose. Place a suture around the lead cap to keep it in place.*

5. Giving consideration to patient anatomy and pulse generator size and motion, gently coil any excess lead and place adjacent to the pulse generator. It is important to place the lead into the pocket in a manner that minimizes lead tension, twisting, sharp angles, and/or pressure.

## Electrical Performance

1. Evaluate the lead signals using the pulse generator.
2. Place the pulse generator into the implant pocket as indicated in the pulse generator physician's manual. Also refer to the instructions in this manual ("Connection to a Pulse Generator" on page 27).
3. Evaluate the lead signals by viewing the real-time EGM. Consider the following:
  - The signal from the implanted lead should be continuous and without artifact, similar to a body-surface ECG.

- A discontinuous signal may indicate a lead conductor coil break, fracture or an otherwise damaged lead, or an insulation break that would necessitate lead replacement.
  - Inadequate signals may result either in a failure of the pulse generator system to detect an arrhythmia or in an unnecessary delivery of therapy.
4. Test for diaphragmatic stimulation by pacing the lead at a high voltage output, using professional medical judgment to select the output voltage. Adjust the lead configurations and lead position as necessary. Testing should be conducted for all lead placements.

---

## POSTIMPLANT

### Postimplant Evaluation

Perform follow-up evaluation as recommended in the applicable pulse generator physician's manual.

**CAUTION:** For some patients, lead performance at implant may not predict performance in the chronic state. Therefore, it is recommended that post-implant lead evaluation follow-up be done at the routine pulse generator follow-up and additionally as necessary.

**WARNING:** Ensure that an external defibrillator and medical personnel skilled in CPR are present during post-implant device testing should the patient require external rescue.

**NOTE:** *Chronic repositioning of the lead may be difficult because of body fluid or fibrotic tissue intrusion.*

### Explantation

**NOTE:** *Return all explanted pulse generators and leads to Boston Scientific. Examination of explanted pulse generators and leads can provide information for continued improvement in system reliability and warranty considerations.*

**WARNING:** Do not reuse, reprocess, or resterilize. Reuse, reprocessing, or resterilization may compromise the structural integrity of the device and/or lead to device failure which, in turn, may result in patient injury, illness, or death. Reuse, reprocessing, or resterilization may also create a risk of contamination of the device and/or cause patient infection or cross-infection, including, but not limited to, the transmission of infectious disease(s) from one patient to another. Contamination of the device may lead to injury, illness, or death of the patient.

Contact Boston Scientific when any of the following occur:

- When a product is removed from service.
- In the event of patient death (regardless of cause), along with an autopsy report, if performed.
- For other observation or complications reasons.



**NOTE:** Disposal of explanted pulse generators and/or leads is subject to applicable laws and regulations. For a Returned Product Kit, contact Boston Scientific using the information on the back cover.

Consider the following items when explanting and returning the pulse generator and/or lead:

- Interrogate the pulse generator and print a comprehensive report.
- Deactivate the pulse generator before explantation.
- Disconnect the leads from the pulse generator.
- If leads are explanted, attempt to remove them intact, and return them regardless of condition. Do not remove leads with hemostats or any other clamping tool that may damage the leads. Resort to tools only if manual manipulation cannot free the lead.
- Wash, but do not submerge, the pulse generator and leads to remove body fluids and debris using a disinfectant solution. Do not allow fluids to enter the pulse generator's lead ports.
- Use a Boston Scientific Returned Product Kit to properly package the pulse generator and/or lead, and send it to Boston Scientific.

## SPECIFICATIONS

### Specifications (Nominal)

**Table 4. Model Number and Lead Length**

| Model | Length (cm) |
|-------|-------------|
| 7740  | 45          |
| 7741  | 52          |
| 7742  | 59          |

**Table 5. Specifications (Nominal)**

| Characteristic   | Nominal  |
|--|--|
| Terminal type  | IS-1BI   |
| Compatibility  | Pulse generators with an IS-1 port, which accepts an IS-1 terminal |
| Fixation   | Extendable/retractable helix                                       |
| Expected number of rotations (at approximately 1 rotation per second) to fully extend/retract the helix <sup>a</sup> | 7 turns with straight stylet<br>8 turns with J stylet              |

**Table 5. Specifications (Nominal) (continued)**

| Characteristic   | Nominal   |
|--|---|
| Recommended maximum number of rotations to extend/retract the helix <sup>a</sup>   | 30 turns  |
| <b>CAUTION:</b> Do not rotate the terminal pin clockwise or counterclockwise more than the recommended maximum number of turns indicated. Continuing to rotate the terminal pin once the helix is fully extended or retracted (as indicated by fluoroscopy) can damage the lead, cause a conductor coil break during fixation, cause lead dislodgment, tissue trauma, and/or cause acute pacing threshold to rise. |   |
| Nominal fixation helix penetration depth   | 1.8 mm  |
| Tip to marker band distal edge   | 0.1 mm  |
| Nominal Electrode Dimensions:  |   |
| Fixation helix surface area  | 4.5 mm <sup>2</sup>                               |
| Distance between electrodes  | 10.7 mm   |
| Anode electrode  | 20 mm <sup>2</sup>                                |
| Nominal Diameter:  |   |
| Insertion  | 2.0 mm (6F)                                       |
| Anode electrode  | 2.0 mm  |
| Lead body  | 1.9 mm  |
| Fixation helix   | 1.2 mm  |
| Material:  |   |
| External insulation  | Polyurethane (55D)                                |
| Internal insulation  | Silicone rubber                                   |
| Terminal ring contact  | 316L stainless steel                              |
| IS-1 terminal pin contact  | 316L stainless steel                              |
| Tip electrode  | IROX (iridium oxide) coated Pt-Ir                 |
| Anode electrode  | IROX (iridium oxide) coated Pt-Ir                 |
| Conductor type   | Single wound helical coils of MP35N™ <sup>b</sup> |
| Steroid  | 0.91 mg dexamethasone acetate                     |
| Radiopaque markers   | Pt-Ir   |
| Suture sleeve  | Radiopaque white silicone rubber                  |
| Maximum Lead Conductor Resistance:   |   |

**Table 5. Specifications (Nominal) (continued)**

| Characteristic                                  | Nominal                                      |
|---|--|
| From terminal ring to anode (or ring) electrode | 45 cm: 130 Ω<br>52 cm: 152 Ω<br>59 cm: 174 Ω |
| From terminal pin to tip electrode              | 45 cm: 180 Ω<br>52 cm: 209 Ω<br>59 cm: 238 Ω |

- a. Use fluoroscopy markers for verification of full extension/retraction of the helix. The number of turns to extend or retract the helix may vary based on patient anatomy and implant conditions.  
b. MP35N is a trademark of SPS Technologies, Inc.

## Lead Introducer









**Table 6. Lead introducer**

| Recommended lead introducer   |             |
|-------------------------------|-------------|
| Introducer without guide wire | 6F (2.0 mm) |
| Introducer with guide wire    | 9F (3.0 mm) |









## Symbols on Packaging

The following symbols may be used on packaging and labeling (Table 7 Symbols on packaging on page 31):

**Table 7. Symbols on packaging**

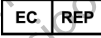
| Symbol  | Description                     |
|---|---------------------------------|
|    | Reference number                |
|   | Serial number                   |
|  | Use by                          |
|  | Lot number                      |
|  | Date of manufacture             |
|  | Sterilized using ethylene oxide |
|  | Do not resterilize              |
|  | Do not reuse                    |

**Table 7. Symbols on packaging** (continued)

| Symbol  | Description  |
|---|--|
|  | Do not use if package is damaged   |
|  | Consult instructions for use on this website: <a href="http://www.bostonscientific-elabelling.com">www.bostonscientific-elabelling.com</a> |
|  | CE mark of conformity with the identification of the notified body authorizing use of the mark   |
|  | Opening instruction  |
|  | Authorized Representative in the European Community  |
|  | Manufacturer   |
|  | Australian Sponsor Address   |
|  | MR Conditional   |

рсия. Да не се използва.  
erze. Nepoužívajte.  
version. Må ikke anvendes.  
n überholt. Nicht verwenden.  
unud version. Ärge kasutage.

αλιά έκδοση. Μην την χρησιμοποιείτε.  
Outdated version. Do not use.  
Versión obsoleta. No utilizar.  
Version périmée. Ne pas utiliser.

Zastarjela verzija. Nemojte upotrebljavati.  
Úreлт útгáфа. Notið ekki.  
Versione obsoleta. Non utilizzare.  
Pasenusi versija. Nenaudokite.  
Elavult verzió. Ne használja!

Dit is een verouderde versie. Niet gebruiken.  
Utdatert versjon. Skal ikke brukes.  
Wersja przeterminowana. Nie używać.  
Versão obsoleta. Não utilize.

Versiune expirată. A nu se utiliza.  
Zastarana verzija. Nepoužívajte.  
Vanhentunut versio. Älä käytä.  
Föråldrad version. Använd  
ancel olmayan sürüm. K

рсия. Да не се използва.  
erze. Nepoužívajte.  
version. Må ikke anvendes.  
n überholt. Nicht verwenden.  
unud version. Ärge kasutage.

αλιά έκδοση. Μην την χρησιμοποιείτε.  
Outdated version. Do not use.  
Versión obsoleta. No utilizar.  
Version périmée. Ne pas utiliser.

Zastarjela verzija. Nemojte upotrebljavati.  
Úrelt útgáfa. Notið ekki.  
Versione obsoleta. Non utilizzare.  
Pasenusi versija. Nenaudokite.  
Elavult verzió. Ne használja!

Dit is een verouderde versie. Niet gebruiken.  
Utdatert versjon. Skal ikke brukes.  
Wersja przeterminowana. Nie używać.  
Versão obsoleta. Não utilize.

Versiune expirată. A nu se utiliza.  
Zastarana verzija. Nepoužívajte.  
Vanhentunut versio. Älä käytä.  
Föråldrad version. Använd  
ancel olmayan sürüm. K

рсия. Да не се използва.  
erze. Nepoužívajte.  
version. Må ikke anvendes.  
n überholt. Nicht verwenden.  
unud version. Ärge kasutage.

αλιά έκδοση. Μην την χρησιμοποιείτε.  
Outdated version. Do not use.  
Versión obsoleta. No utilizar.  
Version périmée. Ne pas utiliser.

Zastarjela verzija. Nemojte upotrebljavati.  
Úreлт útгáфа. Notið ekki.  
Versione obsolete. Non utilizzare.  
Pasenusi versija. Nenaudokite.  
Elavult verzió. Ne használja!

Dit is een verouderde versie. Niet gebruiken.  
Utdatert versjon. Skal ikke brukes.  
Wersja przeterminowana. Nie używać.  
Versão obsoleta. Não utilize.

Versiune expirată. A nu se utiliza.  
Zastarana verzija. Nepoužívajte.  
Vanhentunut versio. Älä käytä.  
Föråldrad version. Använd  
ancel olmayan sürüm. K

# Boston Scientific



Boston Scientific Corporation  
4100 Hamline Avenue North  
St. Paul, MN 55112-5798 USA

EC REP

Guidant Europe NV/SA; Boston Scientific  
Green Square, Lambroekstraat 5D  
1831 Diegem, Belgium

AUS

Boston Scientific (Australia) Pty Ltd  
PO Box 332  
Botany NSW 1455 Australia  
Free Phone 1 800 676 133  
Free Fax 1 800 836 666

[www.bostonscientific.com](http://www.bostonscientific.com)

1.800.CARDIAC (227.3422)

+1.651.582.4000

© 2018 Boston Scientific Corporation or its affiliates.

All rights reserved.  
358659-113 EN Europe 2018.05

**CE0086**

Authorized 2014

