

PHYSICIAN'S LEAD MANUAL

# **ENDOTAK RELIANCE™**

Pace/Sense and Defibrillation Lead

Integrated Bipolar DF4-LLHH and DF4-LLHO Connectors

Tined Fixation

## **ENDOTAK RELIANCE G**

Dual Shock Coils with GORE™ Coating

**REF** 0285, 0286

## **ENDOTAK RELIANCE SG**

Single Shock Coil with GORE™ Coating

**REF** 0282, 0283

## **ENDOTAK RELIANCE**

Dual Shock Coils with Silicone In-Fill

**REF** 0265, 0266

рсия. Да не се използва.  
erze. Nepoužívajte.  
version. Må ikke anvendes.  
n überholt. Nicht verwenden.  
unud version. Ärge kasutage.

αλιά έκδοση. Μην την χρησιμοποιείτε.  
Outdated version. Do not use.  
Versión obsoleta. No utilizar.  
Version périmée. Ne pas utiliser.

Zastarjela verzija. Nemojte upotrebljavati.  
Úreлт útгáфа. Notið ekki.  
Versione obsolete. Non utilizzare.  
Pasenusi versija. Nenaudokite.  
Elavult verzió. Ne használja!

Dit is een verouderde versie. Niet gebruiken.  
Utdatert versjon. Skal ikke brukes.  
Wersja przeterminowana. Nie używać.  
Versão obsoleta. Não utilize.

Versiune expirată. A nu se utiliza.  
Zastarana verzija. Nepoužívajte.  
Vanhentunut versio. Älä käytä.  
Föråldrad version. Använd  
ancel olmayan sürüm. K

# Table of Contents

<b>INFORMATION FOR USE</b> .....	<b>1</b>
Device Description .....	1
Related Information .....	2
MR Conditional System Information .....	2
Indications and Usage .....	3
Contraindications .....	3
Warnings .....	3
Precautions .....	6
Potential Adverse Events .....	10
Warranty Information .....	11
<b>PRE- IMPLANT INFORMATION</b> .....	<b>11</b>
Surgical Preparation .....	12
Items Included .....	12
Accessories .....	12
Vein Pick .....	13
Suture Sleeve .....	13
Stylets .....	13
Lead Cap .....	13
EZ-4 Connector Tool .....	13
Transvalvular Insertion Tool .....	14
<b>IMPLANTATION</b> .....	<b>15</b>
Attaching the Connector Tool to the Lead .....	15
Inserting the Stylet .....	16
Inserting the Lead .....	17
Positioning Lead in Right Ventricle .....	19
Checking for Lead Stability .....	20
Evaluating Lead Performance .....	21
Connection to a Pulse Generator .....	23
Electrical Performance .....	24
Conversion Testing .....	24
Securing the Lead .....	25
Tunneling the Lead .....	28
<b>POSTIMPLANT</b> .....	<b>29</b>
Postimplant Evaluation .....	29
Explanation .....	30
<b>SPECIFICATIONS</b> .....	<b>31</b>
Specifications (Nominal) .....	31
Lead Introducer .....	32
Symbols on Packaging .....	32

DUAL COIL models, DF4-LLHH connector, Tined fixation

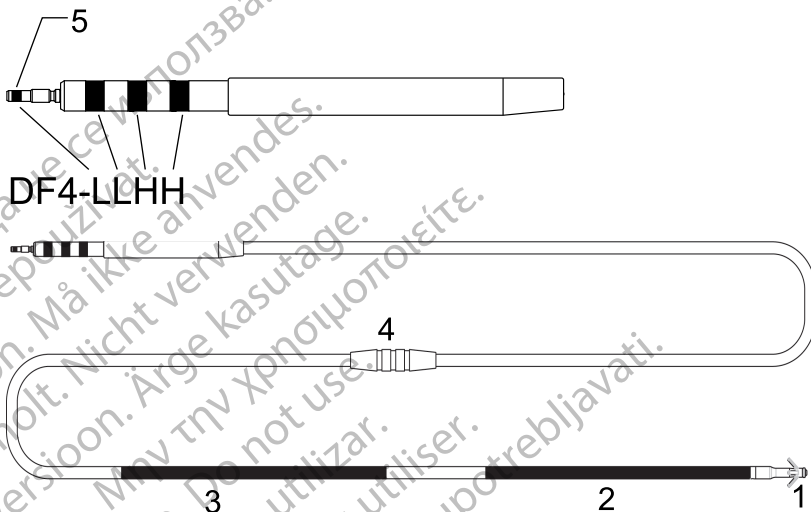

SINGLE COIL models, DF4-LLHO connector, Tined fixation

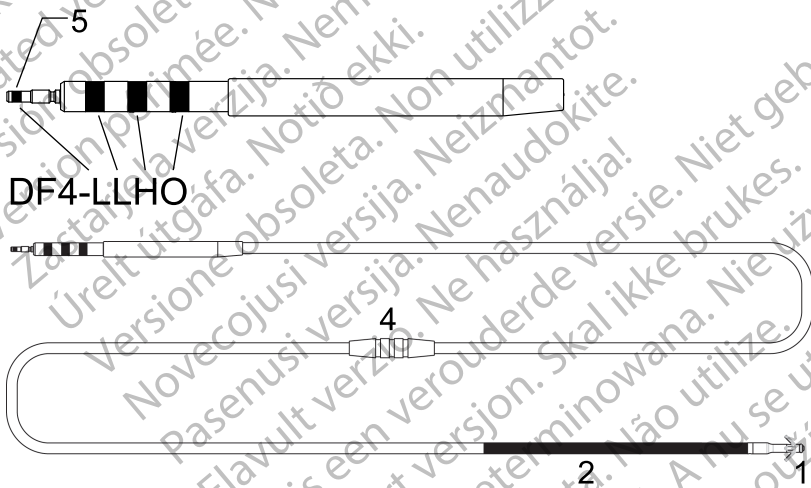

1. Distal steroid-eluting pace/sense electrode (cathode)
2. Proximal pace/sense coil (anode), distal defibrillating coil
3. Proximal defibrillating coil (dual coil models only)
4. Suture sleeve
5. Terminal pin insertion indicator

---

## INFORMATION FOR USE

### Device Description

This lead family has the following characteristics:

- Endocardial cardioversion/defibrillation and pace/sense lead—intended for chronic delivery of cardioverting/defibrillating shocks, and bipolar pacing and sensing capabilities; implanted within the superior vena cava, right atrium, and right ventricle.
- 4-SITE integrated bipolar connector—intended to be connected to a device with a DF4-LLHH port, which accepts either a DF4-LLHH or DF4-LLHO lead. It is configured with in-line contacts and labeled as DF4-LLHH or DF4-LLHO, described below:
  - DF4: indicates the lead contains high voltage contacts<sup>1</sup>
  - L: indicates a connection to a low-voltage pace/sense electrode; first L (terminal pin)—distal pace/sense electrode; second L (proximal ring contact)—proximal pace/sense electrode
  - H: indicates a connection to a high-voltage defibrillation electrode; first H (middle ring contact)—distal coil electrode; second H (distal ring contact)—proximal coil electrode (dual-coil models)
  - O: indicates an inactive distal ring contact (single-coil models)

**NOTE:** *ENDOTAK RELIANCE 4-SITE leads with either a GDT-LLHH/LLHO or DF4-LLHH/LLHO label are equivalent and are compatible with a device containing either a GDT-LLHH or DF4-LLHH port.*

- MR Conditional—leads can be used as part of the ImageReady MR Conditional Defibrillation System when connected to Boston Scientific MR Conditional pulse generators ("MR Conditional System Information" on page 2).
- Porous tip electrode—serves as the cathode for intracardiac right ventricular pacing/sensing; uses a platinum-iridium design that increases the effective active area for sensing by allowing fibrotic tissue ingrowth and an increase in chronic lead tip stability while maintaining a small surface area for pacing. The high impedance performance and low pacing thresholds may combine to increase the pacing longevity of the pulse generator.
- Coil electrodes—the distal coil electrode and the proximal coil electrode (for dual-coil models) serve as the anode and cathode during cardioversion/defibrillation shocks. The distal coil also serves as the anode for pacing and sensing.
- GORE<sup>TM</sup> expanded polytetrafluoroethylene (ePTFE)-covered coils<sup>2</sup>—the ePTFE covering prevents tissue ingrowth around and between the coil filars.

1. DF4 refers to the international standard ISO 27186:2010.
2. GORE is a trademark of W.L. Gore and Associates.

- Steroid-eluting—upon exposure to body fluids, the steroid elutes from the lead to help reduce tissue inflammation response at the distal electrode. The steroid suppresses the inflammatory response believed to cause threshold rises typically associated with implanted pacing electrodes. Lower thresholds are desirable because they can increase pacing safety margins and reduce pacing energy requirements, potentially increasing pulse generator longevity. The nominal dose and structure of the steroid are listed in the specifications (Table 5 Specifications (Nominal) on page 31).
- Tined—silicone rubber tines located proximal to the distal pacing electrode provide fixation to the wall of the heart.
- Lead body—the isodiametric lead body contains one conductor for pacing/sensing. Dual-coil models have two conductors for defibrillation and single-coil models have one conductor for defibrillation. The lead conductors are coated and insulated in separate lumens within the silicone rubber lead body. A second layer of silicone covers the lead body to provide additional insulation and a uniform body diameter. A layer of polyurethane covers the proximal area of the lead body to provide additional abrasion protection in the implantation pocket. The suture sleeve and terminal boot molding are fabricated from molded silicone rubber.
- Lubricious coating—the lead has a proprietary coating that makes the surface more lubricious. This reduces both the static and dynamic coefficients of friction, and makes the lead feel and handle like polyurethane while providing the reliability of silicone.
- Stylet delivery method—the design consists of an open-lumen conductor coil to enable lead delivery using a stylet. Refer to the stylet information ("Stylets" on page 13).

## Related Information

Instructions in the lead manual should be used in conjunction with other resource material, including the applicable pulse generator physician's manual and instructions for use on any implant accessories or tools.

For additional reference information, go to [www.bostonscientific-elabeling.com](http://www.bostonscientific-elabeling.com).

Refer to the ImageReady MR Conditional Defibrillation System MRI Technical Guide<sup>3</sup> (MRI Technical Guide) for information about MRI scanning.

## INTENDED AUDIENCE

This literature is intended for use by professionals trained or experienced in device implant and/or follow-up procedures.

## MR Conditional System Information

These leads can be used as part of the ImageReady MR Conditional Defibrillation System when connected to Boston Scientific MR Conditional pulse generators. Patients with an MR Conditional Defibrillation System may

3. Available at [www.bostonscientific-elabeling.com](http://www.bostonscientific-elabeling.com).

be eligible to undergo MRI scans if performed when all Conditions of Use, as defined in the MRI Technical Guide, are met. Components required for MR Conditional status include specific models of Boston Scientific pulse generators, leads, and accessories; the Programmer/Recorder/Monitor (PRM); and PRM Software Application. For the model numbers of MR Conditional pulse generators and components, as well as a complete description of the ImageReady MR Conditional Defibrillation System, refer to the MRI Technical Guide.

## Implant-related MRI Conditions of Use

The following subset of the MRI Conditions of Use pertains to implantation, and is included as a guide to ensure implantation of a complete ImageReady MR Conditional System. For a full list of Conditions of Use, refer to the MRI Technical Guide. All items on the full list of Conditions of Use must be met in order for an MRI scan to be considered MR Conditional.

- Patient is implanted with the ImageReady MR Conditional Defibrillation System
- No other active or abandoned implanted devices, components, or accessories present such as lead adaptors, extenders, leads, or pulse generators
- Pulse generator implant location restricted to left or right pectoral region
- At least six (6) weeks have elapsed since implantation and/or any lead revision or surgical modification of the MR Conditional Defibrillation System
- No evidence of a fractured lead or compromised pulse generator-lead system integrity

## Indications and Usage

This Boston Scientific lead is indicated for use as follows:

- Intended for pacing, rate-sensing, and delivery of cardioversion and defibrillation shocks when used with a compatible pulse generator

## Contraindications

Use of this Boston Scientific lead is contraindicated for the following patients:

- Patients who have a unipolar pacemaker
- Patients with a hypersensitivity to a maximum single dose of 1.1 mg dexamethasone acetate
- Patients with mechanical tricuspid heart valves

## WARNINGS

### General

- **Labeling knowledge.** Read this manual thoroughly before implantation to avoid damage to the pulse generator and/or lead. Such damage can result in patient injury or death.

- **For single patient use only.** Do not reuse, reprocess, or resterilize. Reuse, reprocessing, or resterilization may compromise the structural integrity of the device and/or lead to device failure which, in turn, may result in patient injury, illness, or death. Reuse, reprocessing, or resterilization may also create a risk of contamination of the device and/or cause patient infection or cross-infection, including, but not limited to, the transmission of infectious disease(s) from one patient to another. Contamination of the device may lead to injury, illness, or death of the patient.
- **Backup defibrillation protection.** Always have external defibrillation equipment available during implant and electrophysiologic testing. If not terminated in a timely fashion, an induced ventricular tachyarrhythmia can result in the patient's death.
- **External-source rescue shocks.** Do not use any component of the lead system to assist in delivery of external-source rescue shocks or extensive tissue damage could occur.
- **Resuscitation availability.** Ensure that an external defibrillator and medical personnel skilled in CPR are present during post-implant device testing should the patient require external rescue.
- **Lead fracture.** Lead fracture, dislodgment, abrasion, or an incomplete connection can cause a periodic or continual loss of pacing or sensing or both.

This could possibly result in arrhythmia nondetection, oversensing of rate, inappropriate delivery of a pulse generator shock, or inadequate delivery of converting energy.

## Handling

- **Excessive flexing.** Although pliable, the lead is not designed to tolerate excessive flexing, bending, or tension. This could cause structural weakness, conductor discontinuity, and/or lead dislodgment.
- **Do not kink leads.** Do not kink, twist, or braid the lead with other leads as doing so could cause lead insulation abrasion damage or conductor damage.
- **Handling the lead without Connector Tool.** Use caution handling the lead terminal when the Connector Tool is not present on the lead. Do not directly contact the lead terminal with any surgical instruments or electrical connections such as PSA (alligator) clips, ECG connections, forceps, hemostats, and clamps. This could damage the lead terminal, possibly compromising the sealing integrity and result in loss of therapy or inappropriate therapy.
- **Handling the terminal while tunneling.** Do not contact any other portion of the lead terminal, other than the terminal pin, even when the lead cap is in place.



## Implant Related

- **Do not implant in MRI site Zone III.** Implant of the system cannot be performed in an MRI site Zone III (and higher) as defined by the American College of Radiology Guidance Document for Safe MR Practices<sup>4</sup>. Some of the accessories packaged with pulse generators and leads, including the torque wrench and stylet wires, are not MR Conditional and should not be brought into the MRI scanner room, the control room, or the MRI site Zone III or IV areas.
- **Separate defibrillation electrode.** In order to deliver defibrillation therapy, the single-coil models must be implanted with an additional defibrillation electrode. It is recommended to use the pectorally implanted defibrillator pulse generator that uses the metallic housing as a defibrillation electrode.
- **Only use Connector Tool for electrical connections.** For DF4-LLHH or DF4-LLHO leads, only use the Connector Tool for electrical connections to pacing system analyzers or similar monitors. Do not attach alligator clips directly to the lead terminal or damage could occur.
- **Obtain appropriate electrode position.** Take care to obtain appropriate electrode position. Failure to do so may result in higher defibrillation thresholds or may render the lead unable to defibrillate a patient whose tachyarrhythmia(s) might otherwise be convertible by a pulse generator system.
- **Proper connections.** When connecting the lead to the pulse generator, it is very important that proper connections are made. The terminal pin must be inserted beyond the setscrew block to enable a proper connection. Visualization of the terminal pin insertion indicator beyond the setscrew block may be used to confirm that the terminal pin is fully inserted into the pulse generator port. Evaluation of the electrical performance of the lead after connection to the pulse generator is the final confirmation of full insertion. An improper connection could result in loss of therapy or inappropriate therapy.

## Post-Implant

- **Magnetic Resonance Imaging (MRI) exposure.** Unless all of the MRI Conditions of Use (as described in the MRI Technical Guide) are met, MRI scanning of the patient does not meet MR Conditional requirements for the implanted system, and significant harm to or death of the patient and/or damage to the implanted system may result.  
Refer to the MRI Technical Guide for potential adverse events applicable when Conditions of Use are met or not met, as well as for a complete list of MRI-related Warnings and Precautions.
- **Diathermy.** Do not subject a patient with an implanted pulse generator and/or lead to diathermy since diathermy may cause fibrillation, burning of the myocardium, and irreversible damage to the pulse generator because of induced currents.

4. Kanal E, et al., American Journal of Roentgenology 188:1447-74, 2007.

# PRECAUTIONS

## Clinical Considerations

- **Dexamethasone acetate.** It has not been determined whether the warnings, precautions, or complications usually associated with injectable dexamethasone acetate apply to the use of a low concentration, highly localized, controlled-release device. Refer to the Physicians' Desk Reference™<sup>5</sup> for a listing of potentially adverse effects.

## Sterilization and Storage

- **If package is damaged.** The blister trays and contents are sterilized with ethylene oxide gas before final packaging. When the pulse generator and/or lead is received, it is sterile provided the container is intact. If the packaging is wet, punctured, opened, or otherwise damaged, return the pulse generator and/or lead to Boston Scientific.
- **Storage temperature.** Store at 25°C (77°F). Excursions are permitted between 15°C to 30°C (59°F to 86°F). Transportation spikes are permitted up to 50°C (122°F).
- **Use by date.** Implant the pulse generator and/or lead before or on the USE BY date on the package label because this date reflects a validated shelf life. For example, if the date is January 1, do not implant on or after January 2.

## Handling

- **Do not immerse in fluid.** Do not wipe or immerse the tip electrode in fluid. Such treatment will reduce the amount of steroid available when the lead is implanted.
- **Chronic repositioning.** Optimum threshold performance might not be achieved if the lead is chronically repositioned because the steroid can be depleted.
- **Protect from surface contamination.** The lead uses silicone rubber which can attract particulate matter, and therefore, must always be protected from surface contamination.
- **Lubricants.** Do not apply oil-based lubricants to the ePTFE-covered shocking coils or it may affect electrical performance.
- **No mineral oil on lead tip.** Mineral oil should never come in contact with the porous-tipped lead electrode. Mineral oil on the porous tip may inhibit tissue ingrowth and conduction.
- **Ensure suture sleeve position.** Ensure the suture sleeve remains proximal to the venous entry site and near the terminal boot molding throughout the procedure until it is time to secure the lead.

5. Physicians' Desk Reference is a trademark of Thomson Healthcare Inc.

## Implantation

- **Evaluate patient for surgery.** There may be additional factors regarding the patient's overall health and medical condition that, while not related to device function or purpose, could render the patient a poor candidate for implantation of this system. Cardiac health advocacy groups may have published guidelines that may be helpful in conducting this evaluation.
- **Lead compatibility.** Prior to implantation, confirm the lead-to-pulse generator compatibility. Using incompatible leads and pulse generators can damage the connector and/or result in potential adverse consequences, such as undersensing of cardiac activity or failure to deliver necessary therapy.
- **Line-powered equipment.** Exercise extreme caution if testing leads using line-powered equipment because leakage current exceeding 10  $\mu\text{A}$  can induce ventricular fibrillation. Ensure that any line-powered equipment is within specifications.
- **Do not bend the lead near the lead-header interface.** Insert the lead terminal straight into the lead port. Do not bend the lead near the lead-header interface. Improper insertion can cause insulation or connector damage.
- **Vein pick.** The vein pick is not intended either for puncturing the vein or for dissecting tissue during a cutdown procedure. Be sure that the vein pick does not puncture the insulation of the lead. This could prevent proper lead function.
- **Do not bend lead with stylet in place.** Do not bend the lead with a stylet in place. Bending the lead could damage the conductor and insulation material.
- **TVI tool use with introducer.** The TVI tool should always be used in conjunction with a hemostatic tear-away introducer to allow the ePTFE-covered coils to freely pass through the hemostatic valve of the introducer.
- **Tools applied to distal end.** Do not apply tools to the distal end of the lead because lead damage could occur. Avoid holding or handling the distal tip of the lead.
- **Curving the stylet.** Do not use a sharp object to curve the distal end of a stylet. Do not curve a stylet while it is in the lead. If a curved stylet is preferred, gently curve a straight stylet before inserting it into the lead to avoid damage to the stylet and lead.
- **Do not implant lead under clavicle.** When attempting to implant the lead via a subclavian puncture, do not introduce the lead under the medial one-third region of the clavicle. Damage or chronic dislodgment to the lead is possible if the lead is implanted in this manner. If implantation via the subclavian vein is desired, the lead must enter the subclavian vein near the lateral border of the first rib to avoid entrapment by the subclavius

muscle or ligamentous structures associated with the narrow costoclavicular region. It has been established in the literature that lead fracture can be caused by lead entrapment in such soft tissue structures as the subclavius muscle, costocoracoid ligament, or the costoclavicular ligament.<sup>6</sup>

- **Electrode distance from pacemaker.** For patients with bipolar cardiac pacemakers, the lead pace/sense electrode (the tip electrode and distal coil electrode) should be placed as far as possible from the pacemaker electrodes to avoid cross-sensing between the defibrillator pulse generator and the pacemaker.
- **Lead dislodgment.** Should dislodgment occur, immediate medical care is required to resolve the electrode position and minimize endocardial trauma.
- **Compatible delivery tools.** Only use compatible delivery tools to deliver the lead because using incompatible delivery tools may cause lead damage or patient injury.
- **Inaccurate rate counting.** R-wave amplitudes of less than the recommended value can cause inaccurate rate counting in the chronic state, possibly resulting in failure to sense a tachyarrhythmia or misdiagnosis of a normal rhythm as abnormal. Signal durations that exceed the programmed refractory period of the pulse generator can cause inaccurate rate sensing which may cause inappropriate behavior.
- **Avoid tight stricture.** When ligating the vein, avoid stricture that is too tight. A tight stricture might damage the insulation or sever the vein. Avoid dislodging the distal tip during the anchoring procedure.
- **Do not remove suture sleeve.** Do not remove or cut the suture sleeve from the lead as it can cause lead damage.
- **Do not suture directly over lead.** Do not suture directly over the lead body, as this may cause structural damage. Use the suture sleeve to secure the lead proximal to the venous entry site to prevent lead movement.
- **Tunnel the lead.** Tunnel the lead from the chest area to the pulse generator implant site. Do not tunnel the lead from the pulse generator implant site to the chest area because this can damage the electrodes or lead body or both by permanently stretching the lead.
- **Excessive tension on lead.** When tunneling the lead, take precautions not to place excessive tension on the lead. This can cause either structural weakness and/or conductor discontinuity.
- **Re-evaluate the lead after tunneling.** After tunneling, re-evaluate the lead to verify that no significant change in signals or damage to the lead has occurred during the tunneling procedure. Reattach the Connector Tool and repeat the steps in Evaluating Lead Performance.

6. Magney JE, et al. Anatomical mechanisms explaining damage to pacemaker leads, defibrillator leads, and failure of central venous catheters adjacent to the sternoclavicular joint. PACE. 1993;16:445-457.

## Hospital and Medical Environments

- **Electrocautery.** Electrocautery may induce ventricular arrhythmias and/or fibrillation, and may cause asynchronous pacing, inhibited pacing, inappropriate shocks, and/or a reduction in pulse generator pacing output possibly leading to loss of capture.

If electrocautery is medically necessary, observe the following to minimize risk to the lead. Also, refer to pulse generator labeling for device programming recommendations and additional information about minimizing risk to the patient and system.

- Avoid direct contact between the electrocautery equipment and the pulse generator or leads.
- Keep the path of the electrical current as far away as possible from the pulse generator and leads.
- If electrocautery is performed on tissue near the device or leads, monitor pre- and post- measurements for sensing and pacing thresholds and impedances to determine the integrity and stability of the system.
- Use short, intermittent, and irregular bursts at the lowest feasible energy levels.
- Use a bipolar electrocautery system where possible.

• **Radio frequency (RF) ablation.** RF ablation may induce ventricular arrhythmias and/or fibrillation, and may cause asynchronous pacing, inhibition of pacing, inappropriate shocks, and/or a reduction in pulse generator pacing output possibly leading to loss of capture. RF ablation may also cause ventricular pacing up to the Maximum Tracking Rate (MTR) and/or changes in pacing thresholds. Additionally, exercise caution when performing any other type of cardiac ablation procedure in patients with implanted devices.

If RF ablation is medically necessary, observe the following to minimize risk to the lead. Also, refer to pulse generator labeling for device programming recommendations and additional information about minimizing risk to the patient and system.

- Avoid direct contact between the ablation catheter and the pulse generator and leads. RF ablation close to the lead electrode may damage the lead-tissue interface.
- Keep the path of the electrical current as far away as possible from the pulse generator and leads.
- If RF ablation is performed on tissue near the device or leads, monitor pre- and post-measurements for sensing and pacing thresholds and impedances to determine the integrity and stability of the system.
- **Central line guidewire insertion.** Use caution when inserting guidewires for placement of other types of central venous catheter systems such as PIC lines or Hickman catheters in locations where pulse generator leads may be encountered. Insertion of such guidewires into veins containing leads could result in the leads being damaged or dislodged.

## Follow-up Testing

- **Unsuccessful conversion testing.** Following an unsuccessful high-energy shock, miscounting of cardiac rate, delayed detection, or nondetection due to low amplitude VF signals, it may be necessary to reposition the lead.
- **Lead performance in chronic state.** For some patients, lead performance at implant may not predict performance in the chronic state. Therefore, it is strongly recommended that post-implant follow-up EP testing be performed should any change occur in lead performance. This testing should include at least one arrhythmia induction/conversion test of ventricular fibrillation.

## Potential Adverse Events

Based on the literature and on pulse generator and/or lead implant experience, the following list includes the possible adverse events associated with implantation of products described in this literature:

- Air embolism
- Allergic reaction
- Arterial damage with subsequent stenosis
- Bleeding
- Bradycardia
- Breakage/failure of the implant instruments
- Cardiac perforation
- Cardiac tamponade
- Chronic nerve damage
- Component failure
- Conductor coil fracture
- Death
- Electrolyte imbalance/dehydration
- Elevated thresholds
- Erosion
- Excessive fibrotic tissue growth
- Extracardiac stimulation (muscle/nerve stimulation)
- Fluid accumulation
- Foreign body rejection phenomena
- Formation of hematomas or seromas
- Heart block
- Hemorrhage
- Hemothorax
- Inability to defibrillate or pace

- Inappropriate therapy (e.g., shocks and antitachycardia pacing [ATP] where applicable, pacing)
- Incisional pain
- Incomplete lead connection with pulse generator
- Infection including endocarditis
- Lead dislodgment
- Lead fracture
- Lead insulation breakage or abrasion
- Lead tip deformation and/or breakage
- Local tissue reaction
- Low amplitude VF signals
- Malignancy or skin burn due to fluoroscopic radiation
- Myocardial trauma (e.g., irritability, injury, tissue damage)
- Myopotential sensing
- Oversensing/undersensing
- Pericardial rub, effusion
- Pneumothorax
- Post-shock rhythm disturbances
- Pulse generator and/or lead migration
- Shunting current during defibrillation with internal or external paddles
- Syncope
- Tachyarrhythmias, which include acceleration of arrhythmias and early, recurrent atrial fibrillation
- Thrombosis/thromboemboli
- Valve damage
- Vasovagal response
- Venous occlusion
- Venous trauma (e.g., perforation, dissection, erosion)

For a list of potential adverse events associated with MRI scanning, refer to the ImageReady MR Conditional Defibrillation System MRI Technical Guide.

## Warranty Information

A limited warranty certificate for the lead is available. For a copy, contact Boston Scientific using the information on the back cover.

---

## PRE- IMPLANT INFORMATION

Proper surgical procedures and techniques are the responsibility of the medical professional. The described implant procedures are furnished only for

informational purposes. Each physician must apply the information in these instructions according to professional medical training and experience.

The lead is designed, sold, and intended for use only as indicated.

A major consideration choosing this lead family is that it does not require a thoracotomy. The physician should weigh its advantages against the patient's ability to withstand additional electrophysiology (EP) testing (arrhythmia induction and conversion test), and a possible thoracotomy, should the lead system prove ineffective.

Various factors, such as disease state or drug therapy, may necessitate repositioning of the defibrillation leads or substitution of one lead system for another in order to facilitate arrhythmia conversion. In some cases, reliable arrhythmia conversion may not be obtained with any leads at the available defibrillation or pulse generator defibrillation energy levels.

Bipolar pacemakers may be used with this lead family and pulse generator as long as the pacemaker and pulse generator do not interact, causing pulse generator nondetection or false detection. Refer to the pulse generator physician's manual for information about minimizing pacemaker interaction.

## Surgical Preparation

Consider the following prior to the implantation procedure:

- Instrumentation for cardiac monitoring, imaging (fluoroscopy), external defibrillation, and lead signal measurements must be available during implant.
- Always isolate the patient from potentially hazardous leakage current when using electrical instrumentation.
- Sterile duplicates of all implantable items should be available for use if accidental damage or contamination occurs.

## Items Included

The following items are packaged with the lead:

- Vein pick
- Stylets
- Lead cap
- Connector Tool
- Transvalvular Insertion tool
- Literature

**NOTE:** The *Transvalvular Insertion tool* is packaged only with models with ePTFE-covered coils.

## Accessories

Separately packaged lead accessories are available in addition to those packaged with the lead.



## Vein Pick

The vein pick is a disposable plastic device designed to assist with insertion into a vein during a cutdown procedure.

## Suture Sleeve

A suture sleeve is an adjustable, tubular reinforcement positioned over the outer lead insulation. It is designed to secure and protect the lead at the venous entry site after lead placement. Using a suture sleeve reduces the possibility of structural damage caused by suturing directly over the lead body. To move the suture sleeve, gently pinch and slide it over the lead until it is in the desired position.

**NOTE:** The suture sleeve is pre-loaded on the lead and is not available as an accessory.

## Stylets

Stylets aid in positioning the lead. Ensure you use the length appropriate to the lead. Stylets of various degrees of stiffness are available depending on implant technique and patient anatomy.

**Table 1. Stylet stiffness and knob color**

Stylet Stiffness <sup>a</sup>	Knob Color
Soft	Green
Firm	White

a. The stylet stiffness is imprinted on the knob.

**Table 2. Stylet length and cap color**

Stylet Length (cm) (Imprinted on cap of the knob)	Cap Color
59	Yellow
64	Green

## Lead Cap

The lead cap may be used to isolate or cap the lead terminal that is not inserted in the pulse generator. Place a suture around the lead cap groove to secure the lead cap to the lead terminal. Use an appropriate cap for lead.

## EZ-4 Connector Tool

The EZ-4 Connector Tool is packaged with the lead and when attached to the lead performs the following functions:

- Protects the lead terminal during the implant procedure.
- Provides a safe and secure connection between PSA patient cables and the lead terminal.
- Guides the stylet into the lead through the stylet funnel.

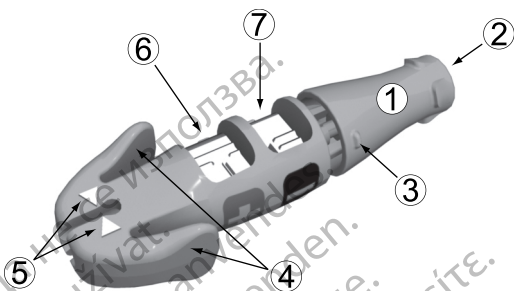

[1] Fixation knob (disengaged) [2] Styllet funnel [3] Rotation mark [4] Terminal boot levers [5] Indicator arrows [6] Anode (+) spring contact [7] Cathode (-) spring contact

**Figure 1. Connector Tool**

### Transvalvular Insertion Tool

The Transvalvular Insertion (TVI) tool is a disposable plastic device designed to allow the use of tear-away hemostatic introducers (Figure 2 TVI tool on page 14). The TVI tool is used to temporarily dilate the hemostatic valve thereby allowing the ePTFE-covered coils to freely pass through the hemostatic valve of the introducer.

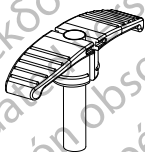

**Figure 2. TVI tool**

The following techniques may be used for the implant procedure with the TVI tool:

1. Step 1 may vary depending on whether a guide wire is used. Use step 1a when a guide wire is not used, and step 1b when a guide wire is used.
  - a. Following insertion of the hemostatic introducer into the vein and removal of the dilator, insert the distal tip of the lead into the TVI tool such that the distal tip is flush or slightly recessed from the distal end of the TVI tool. Grasp the lead and TVI tool combination with the thumb and first finger and insert the assembly into the proximal end of the hemostatic valve. The TVI tool is fully inserted when the base of its handle contacts the proximal end of the introducer.
  - b. Following insertion of the hemostatic introducer into the vein and removal of the dilator, hold the thumb over the proximal exposed opening of the TVI tool and insert the distal end of the TVI tool into the proximal end of the hemostatic introducer by gently pushing the TVI tool through the hemostatic valve.

Continue to hold the thumb over the proximal exposed opening of the TVI tool to prevent air embolization and/or back bleeding. The TVI tool

is fully inserted when the base of its handle contacts the proximal end of the introducer

**NOTE:** *When retaining a guide wire, the TVI tool must be placed over the guide wire and not along the side of it.*

2. Advance the lead through the TVI tool and into the introducer. Continue to advance the lead until the shocking coil(s) is past the hemostatic valve.
3. When the lead is resting inside the introducer, pull the TVI tool out of the hemostatic valve. You may temporarily leave the TVI tool on the body of the lead to facilitate repositioning. Once the lead is in position, you must peel away the TVI tool.

---

## IMPLANTATION

**NOTE:** *Select the appropriate lead length for a given patient. It is important to select a lead that is long enough to avoid any sharp angles or kinks and to allow for a gentle curve of excess lead in the pocket. Typically, a minimum of 5 to 10 cm of excess lead is sufficient to achieve this configuration in the pocket. The suture sleeve should be secured to the lead as close to the vascular access site as clinically appropriate as described in "Securing the Lead" on page 25. Proper placement of the suture sleeve aids in maintaining this configuration in the pocket.*

**NOTE:** *Refer to the MRI Technical Guide for considerations affecting choice and implant of leads for use as part of an MR Conditional system. Use of Boston Scientific MR Conditional pulse generators and leads is required for an implanted system to be considered MR Conditional. Refer to the MRI Technical Guide for model numbers of pulse generators, leads, accessories, and other system components needed to satisfy the Conditions of Use for MR Conditional scanning.*

**NOTE:** *Other implanted devices or patient conditions may cause a patient to be ineligible for an MRI scan, independent of the status of the patient's ImageReady MR Conditional System.*

## Attaching the Connector Tool to the Lead

Follow the steps below to attach the Connector Tool to the lead.

1. Slide the Connector Tool onto the proximal end of the lead (Figure 3 Lead fully inserted into Connector Tool on page 16).
2. While squeezing the EZ-4 Connector Tool wings, push the lead into the tool until the white boot aligns with the arrows on the tool to ensure the lead is fully inserted.
3. Release the terminal boot levers to secure the Connector Tool to the proximal end of the lead.

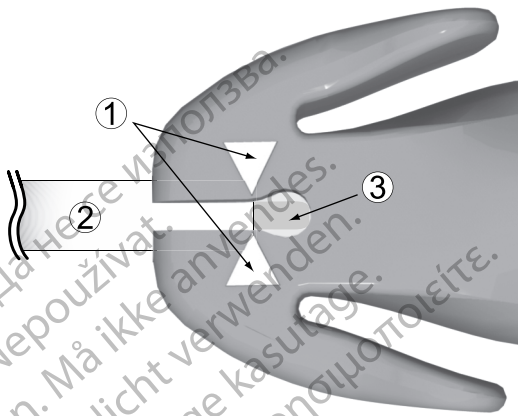

[1] Indicator arrows [2] Terminal boot molding [3] Terminal molding

**Figure 3. Lead fully inserted into Connector Tool**

## Inserting the Stylet

Follow the steps below to insert a stylet.

1. Remove any preinserted stylet before inserting a different one.
2. Select a stylet according to the function and to the preferred firmness. If desired, gently curve the stylet with any sterile, smooth-surfaced instrument (e.g., 10-cc or 12-cc syringe barrel) (Figure 4 Curve the stylet on page 16). A gentle curve is less likely to straighten than a sharp bend as the stylet is used.

**CAUTION:** Do not use a sharp object to curve the distal end of a stylet. Do not curve a stylet while it is in the lead. If a curved stylet is preferred, gently curve a straight stylet before inserting it into the lead to avoid damage to the stylet and lead.

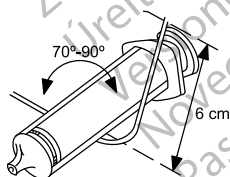

**Figure 4. Curve the stylet**

3. Carefully insert the stylet through the funnel of the Connector Tool and terminal pin.

**NOTE:** To optimize insertion into the lead, do not allow body fluids to come in contact with the stylet.

4. Ensure the stylet is fully inserted in the lead prior to inserting the lead into the vein.

**CAUTION:** Do not bend the lead with a stylet in place. Bending the lead could damage the conductor and insulation material.

## Inserting the Lead

The lead may be inserted using one of the following methods: via the cephalic vein, or through the subclavian or internal jugular vein.

- **Via cutdown through the left or right cephalic vein** Only one incision over the deltopectoral groove is required to access the right or left cephalic vein in the deltopectoral groove.

The vein pick packaged with this lead can be used to aid access during the cutdown procedure. Isolate the selected vein and introduce the point of the vein pick via this incision into the lumen of the vein. With the point of the vein pick facing in the direction of the desired lead passage, gently raise and tilt the pick. Pass the lead under the vein pick and into the vein.

**CAUTION:** The vein pick is not intended either for puncturing the vein or for dissecting tissue during a cutdown procedure. Be sure that the vein pick does not puncture the insulation of the lead. This could prevent proper lead function.

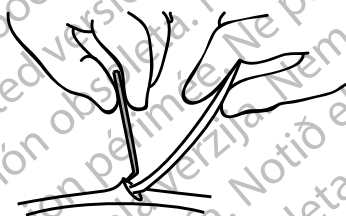

Figure 5. Using the vein pick

- **Percutaneously or via cutdown through the subclavian vein** A subclavian introducer set is available for use during percutaneous lead insertion. Refer to the specifications for the recommended introducer size.

For models with ePTFE-covered coils, if using a hemostatic tear-away introducer, use the TVI tool packaged with this lead as described in the Accessories section. Refer to the specifications for the recommended hemostatic tear-away introducer size.

**CAUTION:** The TVI tool should always be used in conjunction with a hemostatic tear-away introducer to allow the ePTFE-covered coils to freely pass through the hemostatic valve of the introducer.

**CAUTION:** When attempting to implant the lead via a subclavian puncture, do not introduce the lead under the medial one-third region of the clavicle. Damage or chronic dislodgment to the lead is possible if the lead is implanted in this manner. If implantation via the subclavian vein is desired, the lead must enter the subclavian vein near the lateral border of the first rib to avoid entrapment by the subclavius muscle or ligamentous

structures associated with the narrow costoclavicular region. It has been established in the literature that lead fracture can be caused by lead entrapment in such soft tissue structures as the subclavius muscle, costocoracoid ligament, or the costoclavicular ligament.<sup>7</sup>

Leads placed by percutaneous subclavian venipuncture should enter the subclavian vein, where it passes over the first rib (rather than more medially), to avoid entrapment by the subclavius muscle or ligamentous structures associated with the narrow costoclavicular region.<sup>8</sup> It is recommended to introduce the lead into the subclavian vein near the lateral border of the first rib.

The syringe should be positioned directly above and parallel to the axillary vein to reduce the chance that the needle will contact the axillary or subclavian arteries or the brachial plexus. Use of fluoroscopy is helpful in locating the first rib and in guiding the needle.

The steps below explain how to identify the skin entry point and define the course of the needle toward the subclavian vein where it crosses the first rib.

1. Identify points St (sternal angle) and Cp (coracoid process) (Figure 6 Entry point for percutaneous subclavian venipuncture on page 18).

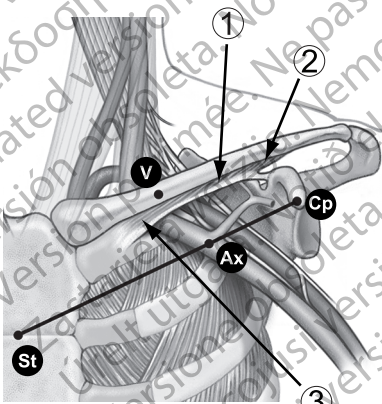

[1] Subclavius muscle [2] Costocoracoid ligament [3] Costoclavicular ligament

### Figure 6. Entry point for percutaneous subclavian venipuncture

2. Visually draw a line between St and Cp, and divide the segment into thirds. The needle should pierce the skin at the junction of the middle and lateral thirds, directly above the axillary vein (point Ax).

7. Magney JE, et al. Anatomical mechanisms explaining damage to pacemaker leads, defibrillator leads, and failure of central venous catheters adjacent to the sternoclavicular joint. PACE. 1993;16:445–457.
8. Magney JE, et al. A new approach to percutaneous subclavian venipuncture to avoid lead fracture or central venous catheter occlusion. PACE. 1993;16:2133–2142.



- Place an index finger on the clavicle at the junction of the medial and middle thirds (point V), beneath which point the subclavian vein should be located.
- Press a thumb against the index finger and project 1–2 centimeters below the clavicle to shield the subclavius muscle from the needle (when hypertrophy of the pectoralis muscle is apparent, the thumb should project about 2 centimeters below the clavicle because the subclavius muscle should be hypertrophied as well) (Figure 7 Location of thumb and needle entry on page 19).

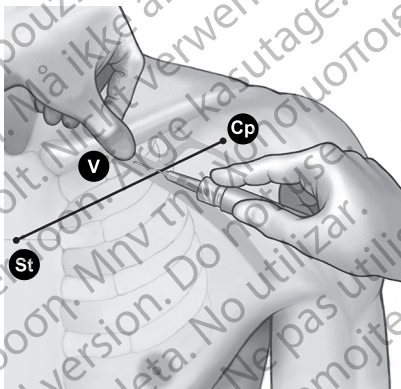

**Figure 7.** Location of thumb and needle entry

- Feel with the thumb the pressure from the passage of the needle through the superficial fascia; direct the needle deep into the tissues toward the subclavian vein and the underlying first rib. Fluoroscopic guidance will reduce the chance that the needle would pass below the first rib and into the lung.

## Positioning Lead in Right Ventricle

Correct functioning of the lead depends on appropriate placement of the electrodes. Follow the instructions below to position the lead.

- Partially withdraw the stylet during lead positioning to minimize tip stiffness.

**NOTE:** A curved stylet may enhance maneuverability.

- Under fluoroscopy and with a stylet in the lead, advance the lead as far as possible until the tip enters and becomes lodged in healthy myocardium in the apex of the right ventricle.

**WARNING:** Take care to obtain appropriate electrode position. Failure to do so may result in higher defibrillation thresholds or may render the lead unable to defibrillate a patient whose tachyarrhythmia(s) might otherwise be convertible by a pulse generator system.

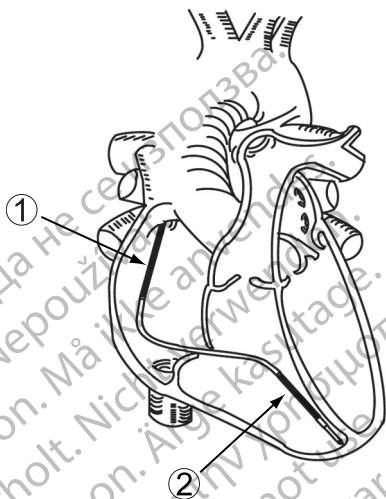

[1] Proximal coil electrode [2] Distal coil electrode

### Figure 8. Suggested electrode position within the heart

3. Verify under fluoroscopy that the distal coil electrode is situated in the right ventricle, below the tricuspid valve, and that the proximal coil electrode (in dual-coil models) is situated in the superior vena cava and high right atrium.

**CAUTION:** For patients with bipolar cardiac pacemakers, the lead pace/sense electrode (the tip electrode and distal coil electrode) should be placed as far as possible from the pacemaker electrodes to avoid cross-sensing between the defibrillator pulse generator and the pacemaker.

4. Ensure sufficient contact between the lead tip and the fixation site.

**WARNING:** In order to deliver defibrillation therapy, the single-coil models must be implanted with an additional defibrillation electrode. It is recommended to use the pectorally implanted defibrillator pulse generator that uses the metallic housing as a defibrillation electrode.

### Checking for Lead Stability

Follow these steps to check lead stability:

1. After fixation, partially withdraw the stylet 20 to 25 cm.
2. Check the stability of the lead using fluoroscopy. Do not tug on the lead. If possible, have the patient cough or take several deep breaths.
3. When the electrode position is satisfactory, withdraw the stylet beyond the right atrium.

**CAUTION:** Should dislodgment occur, immediate medical care is required to resolve the electrode position and minimize endocardial trauma.



# Evaluating Lead Performance

Verify electrical performance of the lead using a pacing system analyzer (PSA) before attaching the lead to the pulse generator.

1. Connect the lead to the PSA.

- Attach the PSA cable alligator clips to the Connector Tool cathode (-) spring contact and anode spring contact (+). Use of the Connector Tool will protect the terminal pin from alligator clip damage and prevent bridging between terminal contacts. Fully engage the alligator clips on the cathode and anode spring contacts to avoid inaccurate baseline measurements (Figure 9 PSA clips attached to Connector Tool on page 21).

**WARNING:** For DF4-LLHH or DF4-LLHO leads, only use the Connector Tool for electrical connections to pacing system analyzers or similar monitors. Do not attach alligator clips directly to the lead terminal or damage could occur.

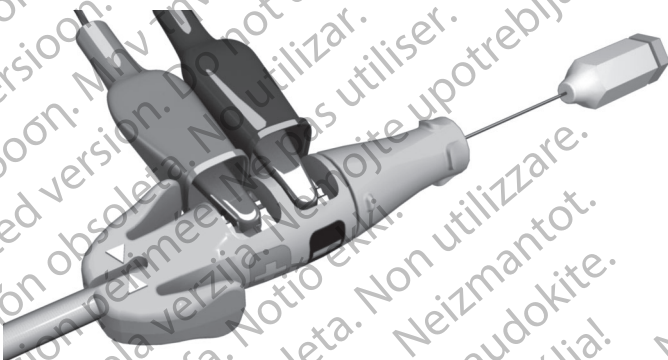

Figure 9. PSA clips attached to Connector Tool

2. Perform the measurements as indicated in the table.

Table 3. Recommended threshold and sensing measurements

Signal Type	Amplitude	Duration	Pacing Threshold <sup>a</sup>	Impedance
Pacing/Sensing	≥ 5 mV	< 100 ms	≤ 1.5 V	450–1800 Ω <sup>b</sup>
Defibrillation	≥ 1 mV	< 150 ms	NA	20–125 Ω

a. Pulse width setting 0.5 ms.

b. The CENELEC pacing and sensing impedance test provides a standardized way to compare the performance of lead designs. The mean CENELEC pacing impedance test result = 1965 Ω, and the mean CENELEC sensing impedance test result = 9.8 kΩ. Boston Scientific does not believe the test result necessarily reflects clinical performance. See the recommended lead impedance values listed in this table.

- Pulse generator measurements may not exactly correlate to the PSA measurements due to signal filtering. Baseline measurements should fall within the recommended values indicated in the table.

- Lower intrinsic potentials, longer durations, and higher pacing threshold may indicate lead placement in ischemic or scarred tissue. Because signal quality may deteriorate, reposition the lead if necessary to obtain a signal with the largest possible amplitude, shortest duration, and lowest pacing threshold.
- Changes in the defibrillation electrode surface area, such as changing from a TRIAD configuration to a single coil configuration, can affect the impedance measurements. Baseline defibrillation impedance measurements should fall within the recommended values indicated in the table.

**CAUTION:** R-wave amplitudes of less than the recommended value can cause inaccurate rate counting in the chronic state, possibly resulting in failure to sense a tachyarrhythmia or misdiagnosis of a normal rhythm as abnormal. Signal durations that exceed the programmed refractory period of the pulse generator can cause inaccurate rate sensing which may cause inappropriate behavior.

3. If measurements do not conform to the values in the table, perform the following steps:

- Remove the PSA alligator clips from the Connector Tool.
- Reinsert the stylet and reposition the lead using the procedures previously discussed and repeat the lead evaluation process.
- If testing results are unsatisfactory, further lead system repositioning or replacement may be required.

Consider the following information:

- Low stimulation threshold readings indicate a desirable safety margin, since stimulation threshold may rise after implantation.
- Initial electrical measurements may deviate from recommendations because of acute cellular trauma. If this occurs, wait approximately 10 minutes and repeat testing. Values may be dependent on patient-specific factors such as tissue condition, electrolyte balance, and drug interactions.
- Amplitude and duration measurements are not inclusive of current of injury and are taken during the patient's normal baseline rhythm.

4. Test for diaphragmatic stimulation by pacing the lead at a high voltage output, using professional medical judgment to select the output voltage. Adjust the lead configurations and lead position as necessary. PSA testing at higher outputs may also be considered to better characterize stimulation margins. Testing should be conducted for all lead placements.
5. Once acceptable measurements are obtained, remove the pacing system analyzer connections, and remove the stylet.
6. Pinch the terminal boot levers and slide the Connector Tool off of the proximal end of the lead.
7. If additional repositioning and/or PSA measurements are necessary, reattach the Connector Tool, ensuring the lead is fully inserted, and repeat the evaluation process.

## Connection to a Pulse Generator

Consult the applicable pulse generator physician's manual for more instructions for connecting lead terminals to the pulse generator.

1. Verify the stylet and any terminal pin accessories are removed prior to connecting the lead to the pulse generator.
2. Grasp the lead body in the labeled area distal to the terminal ring contacts and fully insert the lead terminal into the pulse generator port until the terminal pin is visible beyond the setscrew block. If the terminal pin is difficult to insert, verify the setscrew is completely retracted. Visualization of the terminal pin insertion indicator beyond the setscrew block may be used to confirm that the terminal pin is fully inserted into the pulse generator port.

**NOTE:** *If necessary, lubricate the lead connectors sparingly with sterile water to make insertion easier.*

3. Apply gentle traction to the lead by grasping the labeled area of the lead body to ensure a secure connection.

**CAUTION:** Insert the lead terminal straight into the lead port. Do not bend the lead near the lead-header interface. Improper insertion can cause insulation or connector damage.

**WARNING:** When connecting the lead to the pulse generator, it is very important that proper connections are made. The terminal pin must be inserted beyond the setscrew block to enable a proper connection. Visualization of the terminal pin insertion indicator beyond the setscrew block may be used to confirm that the terminal pin is fully inserted into the pulse generator port. Evaluation of the electrical performance of the lead after connection to the pulse generator is the final confirmation of full insertion. An improper connection could result in loss of therapy or inappropriate therapy.

**NOTE:** *If the lead terminal will not be connected to a pulse generator at the time of lead implantation, you must cap the connector before closing the pocket incision. The lead cap is designed specifically for this purpose. Place a suture around the lead cap to keep it in place.*

4. Giving consideration to patient anatomy and pulse generator size and motion, gently coil any excess lead and place adjacent to the pulse generator. It is important to place the lead into the pocket in a manner that minimizes lead tension, twisting, sharp angles, and/or pressure.

## Electrical Performance

1. Evaluate the lead signals using the pulse generator.
2. Place the pulse generator into the implant pocket as indicated in the pulse generator physician's manual. Also refer to the instructions in this manual ("Connection to a Pulse Generator" on page 23).
3. Evaluate the lead signals by viewing the real-time EGM. Consider the following:
  - The signal from the implanted lead should be continuous and without artifact, similar to a body-surface ECG.
  - A discontinuous signal may indicate a lead fracture or an otherwise damaged lead, or an insulation break that would necessitate lead replacement.
  - Inadequate signals may result either in a failure of the pulse generator system to detect an arrhythmia or in an unnecessary delivery of therapy.
4. Test for diaphragmatic stimulation by pacing the lead at a high voltage output, using professional medical judgment to select the output voltage. Adjust the lead configurations and lead position as necessary. Testing should be conducted for all lead placements.

## Conversion Testing

After obtaining acceptable signals, use the pulse generator to demonstrate ability to reliably convert ventricular fibrillation (VF) and, when appropriate to the patient, ventricular tachycardias. This testing involves inducing arrhythmias and shocking the patient with high-voltage pulses delivered from the pulse generator, through the defibrillation electrodes of the lead, to the heart. Baseline measurements should fall within the recommended values listed in the Recommended threshold and sensing measurements table (Table 3 Recommended threshold and sensing measurements on page 21).

**CAUTION:** Following an unsuccessful high-energy shock, miscounting of cardiac rate, delayed detection, or nondetection due to low amplitude VF signals, it may be necessary to reposition the lead.

**WARNING:** Always have external defibrillation equipment available during implant and electrophysiologic testing. If not terminated in a timely fashion, an induced ventricular tachyarrhythmia can result in the patient's death.

Reliable conversion of VF should be demonstrated at an energy level less than the maximum energy setting of the pulse generator. Consider the following:

- It is recommended that multiple induction conversion tests of VF be performed to determine conversion reliability and the patient's defibrillation threshold (DFT).

- It is a matter of clinical judgment as to what constitutes a demonstration of reliable conversion. Since the result of any single test is subject to statistical variation, a one-time conversion of a rhythm disturbance at a particular energy level does not necessarily predict future conversion energy levels.
- Refer to the applicable pulse generator physician's manual for conversion testing guidelines.
- Weigh the probability of reliable conversion in the ambulatory state against the availability of the pulse generator energy settings and the patient's ability to tolerate multiple arrhythmia inductions.
- If a patient's arrhythmia(s) cannot be reliably converted with the lead, supplementary implantation of an alternate lead system will require additional conversion testing.

**WARNING:** Do not use any component of the lead system to assist in delivery of external-source rescue shocks or extensive tissue damage could occur.

- The decision to implant any pulse generator lead system in any configuration should be based on demonstration of adequate safety margins at the programmed shock energy as determined by DFT and cardioversion energy requirement (CER) testing. Refer to the applicable pulse generator physician's manual for DFT and CER testing requirements.
- Clinical study indicates that a programmed safety margin of 9–10 J above the patient's DFT was used in the majority of patients. If a 9–10 J safety margin cannot be obtained, consider placing an alternative defibrillation lead system.

**NOTE:** *If, after prolonged and repeated inductions of VF, a thoracotomy is to be performed, consider performing it at a later date.*

## Securing the Lead

After the electrodes are satisfactorily positioned, use the suture sleeve to secure the lead to achieve permanent hemostasis and lead stabilization. Suture sleeve tie-down techniques can vary with the lead insertion technique used. Consider the following warning and precautions while securing the lead.

**WARNING:** Do not kink, twist, or braid the lead with other leads as doing so could cause lead insulation abrasion damage or conductor damage.

**CAUTION:** When ligating the vein, avoid stricture that is too tight. A tight stricture might damage the insulation or sever the vein. Avoid dislodging the distal tip during the anchoring procedure.

**CAUTION:** Do not remove or cut the suture sleeve from the lead as it can cause lead damage.

**CAUTION:** Do not suture directly over the lead body, as this may cause structural damage. Use the suture sleeve to secure the lead proximal to the venous entry site to prevent lead movement.

## Percutaneous Implant Technique

1. Peel back the introducer sheath and slide the suture sleeve deep into the tissue (Figure 10 Example of suture sleeve, percutaneous implant technique on page 26).

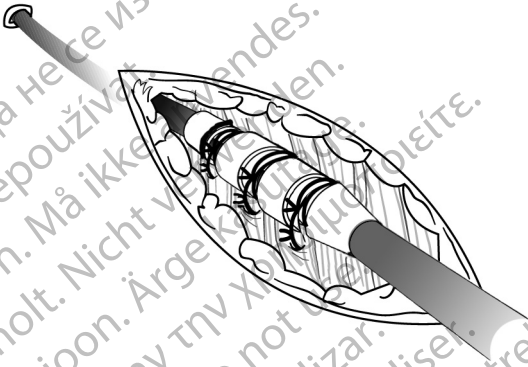
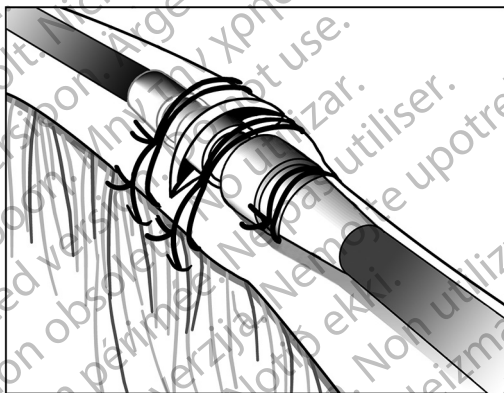

Figure 10. Example of suture sleeve, percutaneous implant technique

2. Using at least two grooves, ligate the suture sleeve and the lead to the fascia. For additional stability, the sleeve may be secured to the lead first before securing the sleeve to the fascia.
3. Check the suture sleeve after tie-down to demonstrate stability and lack of slippage by grasping the suture sleeve with fingers and trying to move the lead in either direction.

### **Venous Cutdown Technique**

1. Slide the suture sleeve into the vein past the distal groove.
2. Ligate the vein around the suture sleeve to obtain hemostasis.
3. Using the same groove, secure the lead and vein to the adjacent fascia (Figure 11 Example of suture sleeve, venous cutdown technique on page 27).



**Figure 11. Example of suture sleeve, venous cutdown technique**

4. Use at least two grooves to secure the sleeve to the lead. Secure the lead and suture sleeve to the adjacent fascia.
5. Check the suture sleeve after tie-down to demonstrate stability and lack of slippage by grasping the suture sleeve with fingers and trying to move the lead in either direction.

## Tunneling the Lead

Follow these steps if tunneling the lead:

1. Allow slack on the lead for strain relief on the lateral side of the suture sleeve near the venous entry site when securing the leads to body tissue. This will prevent lead dislodgment caused by the weight of the pulse generator or upper extremity movement.

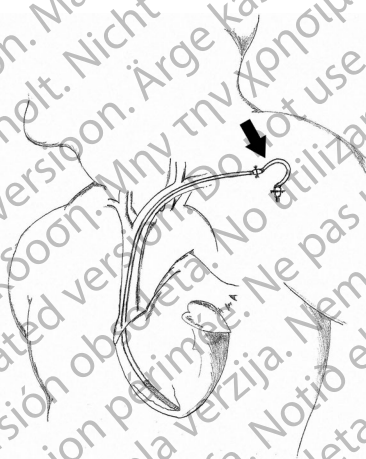

**Figure 12. Strain relief loop**

**WARNING:** Use caution handling the lead terminal when the Connector Tool is not present on the lead. Do not directly contact the lead terminal with any surgical instruments or electrical connections such as PSA (alligator) clips, ECG connections, forceps, hemostats, and clamps. This could damage the lead terminal, possibly compromising the sealing integrity and result in loss of therapy or inappropriate therapy.

2. Remove the stylet and Connector Tool.

**NOTE:** A compatible tunneling tip is recommended for use with this lead if the pulse generator is implanted away from the vein insertion site. Refer to the instructions for use for the tunneling tip and/or tunneler kit if one is being used. When using a compatible tunneling tip, do not cap the lead.

3. Cap the lead terminal if a tunneling tip and/or tunneler kit is not used. Grip the terminal pin with a hemostat, or equivalent.

**WARNING:** Do not contact any other portion of the lead terminal, other than the terminal pin, even when the lead cap is in place.



4. Gently tunnel the lead subcutaneously from the vein insertion site to the implant pocket.

**CAUTION:** Tunnel the lead from the chest area to the pulse generator implant site. Do not tunnel the lead from the pulse generator implant site to the chest area because this can damage the electrodes or lead body or both by permanently stretching the lead.

**CAUTION:** When tunneling the lead, take precautions not to place excessive tension on the lead. This can cause either structural weakness and/or conductor discontinuity.

**CAUTION:** After tunneling, re-evaluate the lead to verify that no significant change in signals or damage to the lead has occurred during the tunneling procedure. Reattach the Connector Tool and repeat the steps in Evaluating Lead Performance.

**NOTE:** *If the tunneling procedure must be delayed, cap the lead terminal and form a temporary pocket for the coiled lead. Capping the terminal protects it and prevents body fluids from entering the lumen of the lead.*

5. Reattach the lead terminals to the pulse generator and evaluate lead signals with the pulse generator as previously described.

- If the measurements are unacceptable, check the electrical connections. A discontinuous or abnormal signal may indicate dislodgment, a loose connection, or lead damage.
- If necessary, reposition the lead electrodes until acceptable values are obtained. To reposition the lead, carefully withdraw the tunneled portion back to the venous entry site. Release the permanent ligatures and reposition the lead using procedures previously discussed.

---

## POSTIMPLANT

### Postimplant Evaluation

Perform follow-up evaluation as recommended in the applicable pulse generator physician's manual.

**CAUTION:** For some patients, lead performance at implant may not predict performance in the chronic state. Therefore, it is strongly recommended that post-implant follow-up EP testing be performed should any change occur in lead performance. This testing should include at least one arrhythmia induction/conversion test of ventricular fibrillation.

**WARNING:** Ensure that an external defibrillator and medical personnel skilled in CPR are present during post-implant device testing should the patient require external rescue.

**NOTE:** *Chronic repositioning of the lead may be difficult because of body fluid or fibrotic tissue intrusion.*

## Explantation

**NOTE:** Return all explanted pulse generators and leads to Boston Scientific. Examination of explanted pulse generators and leads can provide information for continued improvement in system reliability and warranty considerations.

**WARNING:** Do not reuse, reprocess, or resterilize. Reuse, reprocessing, or resterilization may compromise the structural integrity of the device and/or lead to device failure which, in turn, may result in patient injury, illness, or death. Reuse, reprocessing, or resterilization may also create a risk of contamination of the device and/or cause patient infection or cross-infection, including, but not limited to, the transmission of infectious disease(s) from one patient to another. Contamination of the device may lead to injury, illness, or death of the patient.

Contact Boston Scientific when any of the following occur:

- When a product is removed from service.
- In the event of patient death (regardless of cause), along with an autopsy report, if performed.
- For other observation or complications reasons.

**NOTE:** Disposal of explanted pulse generators and/or leads is subject to applicable laws and regulations. For a Returned Product Kit, contact Boston Scientific using the information on the back cover.

Consider the following items when explanting and returning the pulse generator and/or lead:

- Interrogate the pulse generator and print a comprehensive report.
- Deactivate the pulse generator before explantation.
- Disconnect the leads from the pulse generator.
- If leads are explanted, attempt to remove them intact, and return them regardless of condition. Do not remove leads with hemostats or any other clamping tool that may damage the leads. Resort to tools only if manual manipulation cannot free the lead.
- Wash, but do not submerge, the pulse generator and leads to remove body fluids and debris using a disinfectant solution. Do not allow fluids to enter the pulse generator's lead ports.
- Use a Boston Scientific Returned Product Kit to properly package the pulse generator and/or lead, and send it to Boston Scientific.

# SPECIFICATIONS

## Specifications (Nominal)

Table 4. Model Number and Lead Length

ENDOTAK RELIANCE SG Model	ENDOTAK RELIANCE G Model	ENDOTAK RELIANCE Model	Length
0282	0285	0265	59 cm
0283	0286	0266	64 cm

Table 5. Specifications (Nominal)

Characteristic	Nominal
Terminal type	DF4-LLHH (dual-coil models) DF4-LLHO (single-coil models)
Compatibility	Pulse generators with a DF4-LLHH port, which accepts either a DF4-LLHH or DF4-LLHO terminal
Fixation	Tined
Electrode:	
Distal coil surface area	450 mm <sup>2</sup>
Proximal coil surface area (dual-coil models)	660 mm <sup>2</sup>
Porous tip surface area	2.0 mm <sup>2</sup>
Tip to proximal coil electrode length (dual-coil models)	18 cm
Tip to distal coil electrode length	12 mm
Diameter:	
Insertion	3.0 mm (9F)
Isodiametric lead body	2.7 mm
Material:	
External insulation	Silicone rubber
Terminal molding	Polyurethane (75D)
Terminal pin and ring contacts	MP35N™ a nickel-cobalt alloy
Pace/sense conductor	MP35N™ a nickel-cobalt alloy, PTFE covered

**Table 5. Specifications (Nominal)** (continued)

Characteristic	Nominal
Shocking conductor	Drawn brazed strand cable, ETFE coated
Tip electrode	Platinum iridium alloy
Distal fitting electrode	Titanium
Coil electrode covering (models with ePTFE-covered coils)	ePTFE
Coil backfill (models without ePTFE-covered coils)	Silicone
Steroid	0.87 mg dexamethasone acetate
Maximum Lead Conductor Resistance:	
From (low voltage) terminal pin to distal tip electrode	150 $\Omega$
From (low voltage) proximal terminal ring contact to distal coil electrode	150 $\Omega$
From (high voltage) middle terminal ring contact to distal coil electrode	1.9 $\Omega$
From (high voltage) distal terminal ring contact to proximal coil electrode (dual coil models)	2.0 $\Omega$

a. MP35N is a trademark of SPS Technologies, Inc.

## Lead Introducer

**Table 6. Lead introducer**

Recommended lead introducer	Without guide wire <sup>a</sup>
Non-hemostatic introducer	9F (3.0 mm)
Hemostatic introducer	9.5F (3.17 mm)
Hemostatic introducer with TVL tool <sup>b</sup>	9.5F (3.17 mm)

a. When retaining a guide wire, a larger introducer will be needed.

b. For models with ePTFE-covered coils.

## Symbols on Packaging

The following symbols may be used on packaging and labeling (Table 7 Symbols on packaging on page 33):

**Table 7. Symbols on packaging**

Symbol	Description
	Reference number
	Serial number
	Use by
	Lot number
	Date of manufacture
	Sterilized using ethylene oxide
	Do not resterilize
	Do not reuse
	Do not use if package is damaged
	Consult instructions for use on this website: <a href="http://www.bostonscientific-elabeling.com">www.bostonscientific-elabeling.com</a>
	CE mark of conformity with the identification of the notified body authorizing use of the mark
	Opening instruction
	Authorized Representative in the European Community
	Manufacturer
	Australian Sponsor Address
	MR Conditional

рсия. Да не се използва.  
erze. Nepoužívajte.  
version. Må ikke anvendes.  
n überholt. Nicht verwenden.  
unud version. Ärge kasutage.

αλιά έκδοση. Μην την χρησιμοποιείτε.  
Outdated version. Do not use.  
Versión obsoleta. No utilizar.  
Version périmée. Ne pas utiliser.

Zastarjela verzija. Nemojte upotrebljavati.  
Úreлт útгáфа. Notið ekki.  
Versione obsolete. Non utilizzare.  
Pasenusi versija. Nenaudokite.  
Elavult verzió. Ne használja!

Dit is een verouderde versie. Niet gebruiken.  
Utdatert versjon. Skal ikke brukes.  
Wersja przeterminowana. Nie używać.  
Versão obsoleta. Não utilize.

Versiune expirată. A nu se utiliza.  
Zastarana verzija. Nepoužívajte.  
Vanhentunut versio. Älä käytä.  
Föråldrad version. Använd  
ancel olmayan sürüm. K

рсия. Да не се използва.  
erze. Nepoužívajte.  
version. Må ikke anvendes.  
n überholt. Nicht verwenden.  
unud version. Ärge kasutage.

αλιά έκδοση. Μην την χρησιμοποιείτε.  
Outdated version. Do not use.  
Versión obsoleta. No utilizar.  
Version périmée. Ne pas utiliser.

Zastarjela verzija. Nemojte upotrebljavati.  
Úrelt útgáfa. Notið ekki.  
Versione obsoleta. Non utilizzare.  
Pasenusi versija. Nenaudokite.  
Elavult verzió. Ne használja!

Dit is een verouderde versie. Niet gebruiken.  
Utdatert versjon. Skal ikke brukes.  
Wersja przeterminowana. Nie używać.  
Versão obsoleta. Não utilize.

Versiune expirată. A nu se utiliza.  
Zastarana verzija. Nepoužívajte.  
Vanhentunut versio. Älä käytä.  
Föråldrad version. Använd  
ancel olmayan sürüm. K

# Boston Scientific



Boston Scientific Corporation  
4100 Hamline Avenue North  
St. Paul, MN 55112-5798 USA

EC REP

Guidant Europe NV/SA; Boston Scientific  
Green Square, Lambroekstraat 5D  
1831 Diegem, Belgium

AUS

Boston Scientific (Australia) Pty Ltd  
PO Box 332  
Botany NSW 1455 Australia  
Free Phone 1 800 676 133  
Free Fax 1 800 836 666

[www.bostonscientific.com](http://www.bostonscientific.com)

1.800.CARDIAC (227.3422)

+1.651.582.4000

© 2015 Boston Scientific Corporation or its affiliates.

All rights reserved.  
358079-079 EN Europe, 2015-03

**CE0086**

Authorized 2009

