



Endoscopy

2026 Product Reference Guide



When we challenge today's standard of care, we advance meaningful innovation.

A patient-centric mindset is the driving force behind everything we do at Boston Scientific.

We are committed to developing minimally invasive technologies to advance the standard of care in gastrointestinal and pulmonary health and finding new ways to meet our customers' evolving needs.

We are here to help solve the challenges impacting the healthcare professionals we serve.

Scan the QR code or visit bostonscientific.com/ecommerce to learn more about:

- ▶ Products
- ▶ Ordering Information
- ▶ Services and Solutions

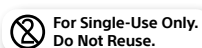

*Product with this symbol may be used in Magnetic Resonance environment according to the conditions described in Directions for Use.

Product Table of Contents

➤ Biliary Access

- Guidewires 1
- RX Preloaded Sphincterotomes 4
- RX Sphincterotomes 7
- Preloaded Sphincterotomes 8
- Sphincterotomes 9
- RX Cannulas 11
- Cannulas 12
- Accessories 13
- Rapid Refill Continuous Injection System 13

➤ Biliary Stricture and Stone Management

- Biliary Metal Stents 14
- Biliary Plastic Stents 17
- Pancreatic Plastic Stents 22
- RX Stone Management 28
- Stone Management 29
- CRE™ Wireguided Balloon Dilatation Catheters 30
- Pancreaticobiliary Ablation 31
- RX Dilatation 31
- RX Cytology 32
- RX Accessories 32

➤ Imaging Systems

- SpyGlass™ Discover Digital Catheter ... 33
- SpyGlass™ DS Direct Visualization System 34
- Autolith™ Touch Biliary EHL System 35
- EXALT™ Model D Single-Use Duodenoscope 36
- ExpertCare 37

➤ EUS

- Expect™ Slimline (SL) Endoscopic Ultrasound Aspiration Needles 40
- Acquire™ Endoscopic Ultrasound Fine Needle Biopsy (FNB) Device 40
- LumiCoil™ Platinum Fiducial Markers 41
- AXIOS™ System 41

➤ Enteral and Esophageal Stents

- Colonic and Duodenal Stents 42
- Esophageal Stents 44

➤ Hemostasis

- Clipping Devices 48
- Bipolar Electrohemostasis Catheters ... 49
- Needles 50
- Multiple Band Ligators 51
- Electrosurgical Bipolar Cable Adapter... 52

➤ Defect Closure

- X-Tack 53
- Clipping Devices 54

➤ Endobariatrics

- Orbera Intra-gastric Balloon System ... 56
- Intra-gastric Balloon Removal Kit 56
- OverStitch™ Endoscopic Suture System .. 57
- OverStitch NXT™ NeXT Generation Single Channel Endoscopic System 57
- OverStitch™ 2-0 Polypropylene Suture .. 58
- OverStitch™ Suture Cinch 58
- OverStitch™ Tissue Helix 59
- OverStitch NXT™ Tissue Helix Pro 59
- OverTube™ Endoscopic Access System.. 60
- Ensizor® Endoscopic Scissors (Gastric Length) 60
- Ensizor® Endoscopic Scissors (Colonic length) 60

➤ Dilation

- CRE™ Balloon Dilatation Catheters 61
- Rigiflex™ II Single-Use Achalasia Balloon Dilatation Catheter 65
- Inflation Systems and Dilation Accessories 66

➤ Biopsy

- Forceps 67

➤ Enteral Access

- Percutaneous Endoscopic Gastrostomy (PEG) Devices with ENFit™ 69
- Percutaneous Endoscopic Gastrostomy (PEG) Devices 73

➤ Resection & Retrieval

- EMR for Upper GI 78
- Stiff Snares 78
- Specialty Snares 80
- Active Cords 82
- Electrosurgical Knife 82
- Retrieval Device 83
- Retrieval Grasping Forceps 83
- Polyp Traps 83

➤ Infection Prevention

- Cleaning Brushes 84
- Detergent 84
- Bite Blocks 84
- Lubricant 85
- Gowns 85
- Irrigation & Insufflation 85
- Scope Transport 86
- Sponges 86
- Suction Tubing 86
- Valves 87
- Compliance EndoKit™ 87
- Aegis One-Hour Indicator 87

➤ Pulmonary

- Scivita Single-Use Bronchoscope 88
- Airway Stents 89
- Biopsy Forceps 91
- iNod™ Ultrasound Guidance System ... 91
- Endobronchial Ultrasound (EBUS) Transbronchial Aspiration Needle 92
- Endobronchial Ultrasound Fine Needle Biopsy (FNB) Device 92
- Transbronchial Intra-Nodal Forceps Biopsy (IFB) Device 92
- Transbronchial Aspiration Needles 93
- Cytology Brushes 93
- Airway Retrieval Baskets 93
- Infection Prevention 93
- Controlled Radial Expansion Pulmonary Balloon Dilatation Catheter 94
- Pulmonary Guidewires 94
- Inflation System 94



Biliary Access

Guidewires

- Amplatz Super Stiff™ Guidewire 1
- Dreamwire™ High Performance Guidewire 1
- Hydra Jagwire™ High Performance Guidewire 1
- Jagtail™ Guidewire Extension 2
- Jagwire™ High Performance Guidewire 2
- Jagwire Revolution High Performance Guidewire 2
- NaviPro™ Hydrophilic Guidewire 3
- NovaGold™ High Performance Guidewire 3
- WALLSTENT™ Super Stiff Guidewire 3

RX Preloaded Sphincterotomes

- Autotome™ Pro RX Cannulating Sphincterotome 4
- Dreamtome™ RX Cannulating Sphincterotome
(Preloaded with Dreamwire High Performance Guidewire) ... 4
- Hydratome™ RX Cannulating Sphincterotome (Preloaded
with Hydra Jagwire High Performance Guidewire) 5
- Jagtome Revolution RX Cannulating Sphincterotome (Preloaded
with Jagwire Revolution High Performance Guidewire) 6
- Jagtome™ RX Cannulating Sphincterotome
(Preloaded with Jagwire High Performance Guidewire) 6

RX Sphincterotomes

- Autotome™ RX Cannulating Sphincterotome 7
- Autotome™ Pro RX Cannulating Sphincterotome 7
- RX Cholangiogram Kits 7
- RX Needle Knife XL Triple-Lumen Needle Knife 7

Preloaded Sphincterotomes

- TRUetome Dreamwire Cannulating Sphincterotome
(Preloaded with Dreamwire High Performance Guidewire) ... 8
- TRUetome Hydra Cannulating Sphincterotome
(Preloaded with Hydra Jagwire High Performance Guidewire) ... 8
- TRUetome™ Jag Cannulating Sphincterotome
(Preloaded with Jagwire High Performance Guidewire) 8
- TRUetome Revolution RX Cannulating Sphincterotome
(Preloaded with Jagwire Revolution High
Performance Guidewire) 8

Sphincterotomes

- TRUetome Cannulating Sphincterotome 9
- MicroKnife™ XL Triple-Lumen Needle Knife 9
- Stonetome™ Stone Removal Device 10
- Ultratome XL Triple-Lumen Sphincterotome 10
- Ultratome™ Double-Lumen Sphincterotome 11

RX Cannulas

- Rapid Exchange XL Cannula 11
- RX ERCP Cannulas 11

Cannulas

- Tandem™ XL Triple-Lumen ERCP Cannula 12
- Contour™ ERCP Cannulas 12

Accessories

- Active Cords
(Fits Boston Scientific Endoscopy Sphincterotome) 13

Rapid Refill Continuous Injection System

- Rapid Refill Continuous Injection System 13

GUIDEWIRES

Amplatz Super Stiff™ Guidewire

Order Number	GTIN	Description	Distal Tip O.D. (in)	Working Length (cm)	Tip	Packaging
M00550090	8714729301929	Amplatz Super Stiff Guidewire	.038	260	Straight	Each

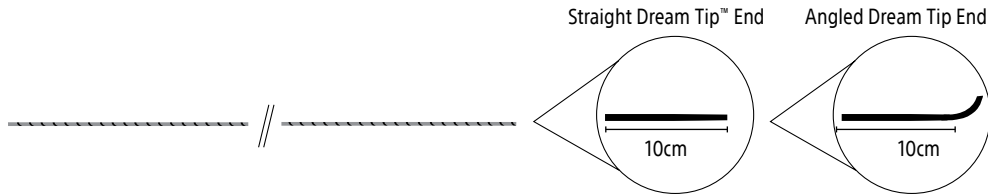

Dreamwire™ High Performance Guidewire



Order Number	GTIN	Description	Distal Tip O.D. (in)	Working Length (cm)	Shaft Style	Dream Tip Style	Tip	Packaging
M00556101	08714729777816	Dreamwire Guidewire ST	.035	260	Standard	Straight	Round	Box 2
M00556111	08714729777847	Dreamwire Guidewire ANG	.035	260	Standard	Angled	Round	Box 2
M00556121	08714729777830	Dreamwire Guidewire ST Stiff	.035	260	Stiff	Straight	Round	Box 2
M00556131	08714729777823	Dreamwire Guidewire ANG Stiff	.035	260	Stiff	Angled	Round	Box 2
M00556141	08714729777885	Dreamwire Guidewire ST	.035	450	Standard	Straight	Round	Box 2
M00556151	08714729777878	Dreamwire Guidewire ANG	.035	450	Standard	Angled	Round	Box 2
M00556161	08714729777861	Dreamwire Guidewire ST Stiff	.035	450	Stiff	Straight	Round	Box 2
M00556171	08714729777854	Dreamwire Guidewire ANG Stiff	.035	450	Stiff	Angled	Round	Box 2

ST = Straight, ANG = Angled

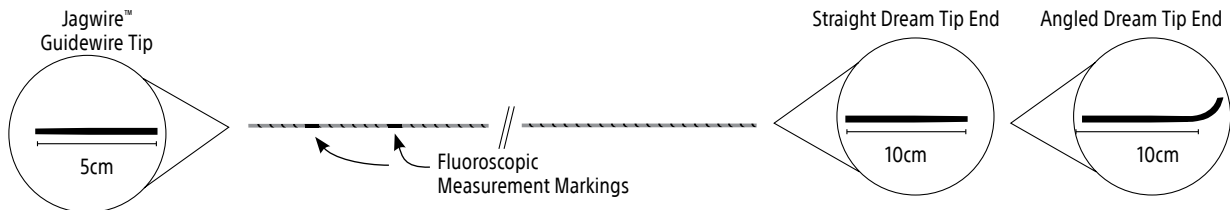

Hydra Jagwire™ High Performance Guidewire



Order Number	GTIN	Description	Distal Tip O.D. (in)	Working Length (cm)	Shaft Style	Dream Tip Style	Tip	Packaging
M00556001	08714729648437	Hydra Jagwire Guidewire ST	.035	260	Standard	Straight	Round	Box 2
M00556011	08714729648444	Hydra Jagwire Guidewire ANG	.035	260	Standard	Angled	Round	Box 2
M00556021	08714729648451	Hydra Jagwire Guidewire ST Stiff	.035	260	Stiff	Straight	Round	Box 2
M00556031	08714729648468	Hydra Jagwire Guidewire ANG Stiff	.035	260	Stiff	Angled	Round	Box 2
M00556041	08714729648475	Hydra Jagwire Guidewire ST	.035	450	Standard	Straight	Round	Box 2
M00556051	08714729648482	Hydra Jagwire Guidewire ANG	.035	450	Standard	Angled	Round	Box 2
M00556061	08714729648499	Hydra Jagwire Guidewire ST Stiff	.035	450	Stiff	Straight	Round	Box 2
M00556071	08714729648505	Hydra Jagwire Guidewire ANG Stiff	.035	450	Stiff	Angled	Round	Box 2

Hydra Jagwire Guidewire may remain in place during sphincterotomy. See Instructions for Use for details.

ST = Straight, ANG = Angled

GUIDEWIRES (Continued)

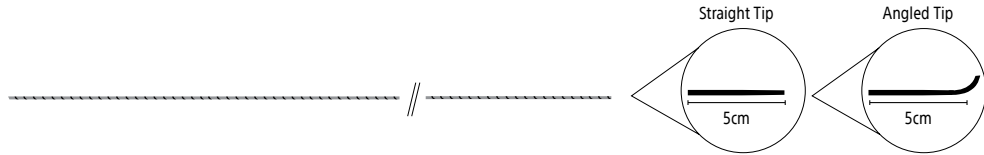

Jagwire™ High Performance Guidewire

Order Number	GTIN	Description	Distal Tip O.D. (in)	Working Length (cm)	Shaft Style	Tip Style	Tip	Packaging
M00556511	08714729874492	Jagwire Guidewire ANG	.025	450	Standard	Angled	Round	Box 2
M00556521	08714729874508	Jagwire Guidewire ST Stiff	.025	450	Stiff	Straight	Round	Box 2
M00556531	08714729874515	Jagwire Guidewire ANG Stiff	.025	450	Stiff	Angled	Round	Box 2
M00556561	08714729501374	Jagwire Guidewire ST	.025	450	Standard	Straight	Trim	Box 2
M00556581	08714729339151	Jagwire Guidewire ST	.035	450	Standard	Straight	Trim	Box 2
M00556591	08714729501398	Jagwire Guidewire ANG	.035	450	Standard	Angled	Trim	Box 2
M00556601	08714729172154	Jagwire Guidewire ST Stiff	.035	450	Stiff	Straight	Trim	Box 2
M00556611	08714729172161	Jagwire Guidewire ANG Stiff	.035	450	Stiff	Angled	Trim	Box 2
M00556621	08714729172178	Jagwire Guidewire ST	.038	260	Standard	Straight	Trim	Box 2
M00556631	08714729172185	Jagwire Guidewire ST Stiff	.035	260	Stiff	Straight	Trim	Box 2
M00556641	08714729172192	Jagwire Guidewire ST	.035	260	Standard	Straight	Trim	Box 2
M00556651	08714729172208	Jagwire Guidewire ANG	.035	260	Standard	Angled	Trim	Box 2
M00556661	08714729172215	Jagwire Guidewire ANG Stiff	.035	260	Stiff	Angled	Trim	Box 2
M00556461	08714729415183	Jagwire Guidewire ST	.025	260	Standard	Straight	Round	Box 2
M00556481	08714729415190	Jagwire Guidewire ST Stiff	.025	260	Stiff	Straight	Round	Box 2
M00556491	08714729415206	Jagwire Guidewire ANG Stiff	.025	260	Stiff	Angled	Round	Box 2
M00556841	08714729268680	Extendable Jagwire Guidewire ST	.035	260	Standard	Straight	Round	Box 2
M00556851	08714729268697	Extendable Jagwire Guidewire ANG	.035	260	Standard	Angled	Round	Box 2
M00556861	08714729268703	Extendable Jagwire Guidewire ST Stiff	.035	260	Stiff	Straight	Round	Box 2
M00556871	08714729268710	Extendable Jagwire Guidewire ANG Stiff	.035	260	Stiff	Angled	Round	Box 2
M00556902	08714729268734	Jagtail™ Guidewire Extension	.035	200	-	Guidewire extension	-	Box 5

Jagwire Guidewire may remain in place during sphincterotomy. See Instructions for Use for details.
ST = Straight, ANG = Angled



Jagwire Revolution High Performance Guidewire

Order Number	GTIN	Description	Distal Tip O.D. (in)	Working Length (cm)	Tip Style	Tip	Packaging
M00557001	08714729934974	Jagwire Revolution High Performance Guidewire- ST	.025	260	Straight	Round	Box 2
M00557011	08714729934981	Jagwire Revolution High Performance Guidewire- ANG	.025	260	Angled	Round	Box 2
M00557021	08714729934998	Jagwire Revolution High Performance Guidewire- ST	.025	450	Straight	Round	Box 2
M00557031	08714729935001	Jagwire Revolution High Performance Guidewire- ANG	.025	450	Angled	Round	Box 2
M00557041	08714729935018	Jagwire Revolution High Performance Guidewire- ST	.025	500	Straight	Round	Box 2

Jagwire Guidewire may remain in place during sphincterotomy. See Instructions for Use for details.
ST = Straight, ANG = Angled

GUIDEWIRES (Continued)

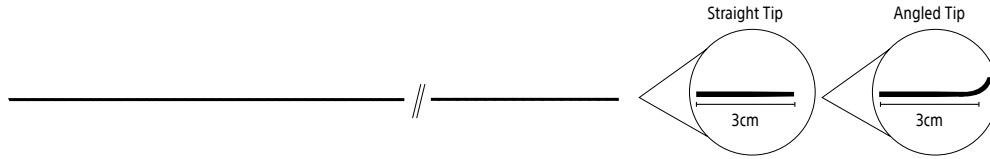

NaviPro™ Hydrophilic Guidewire



Order Number	GTIN	Description	Guidewire Diameter (in)	Length (cm)	Shaft Style	Tip Style	Packaging
M00556191	08714729839873	NaviPro Hydrophilic Guidewire	0.018	260	Standard	Angled	Box 5
M00556181	08714729839866	NaviPro Hydrophilic Guidewire	0.018	260	Standard	Straight	Box 5
M00556211	08714729839897	NaviPro Hydrophilic Guidewire	0.025	260	Standard	Angled	Box 5
M00556201	08714729839880	NaviPro Hydrophilic Guidewire	0.025	260	Standard	Straight	Box 5
M00556231	08714729839910	NaviPro Hydrophilic Guidewire	0.035	260	Standard	Angled	Box 5
M00556221	08714729839903	NaviPro Hydrophilic Guidewire	0.035	260	Standard	Straight	Box 5
M00556251	08714729839934	NaviPro Hydrophilic Guidewire	0.035	260	Stiff	Angled	Box 5
M00556241	08714729839927	NaviPro Hydrophilic Guidewire	0.035	260	Stiff	Straight	Box 5

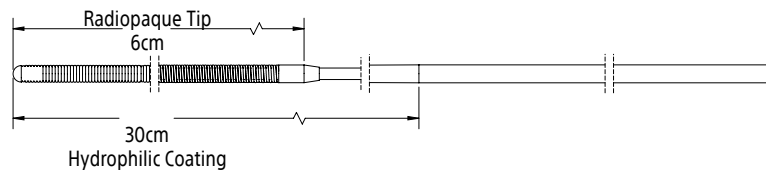

NovaGold™ High Performance Guidewire



Order Number	GTIN	Description	Distal Tip O.D. (in)	Working Length (cm)	Tip Style	Tip Length (cm)	Packaging
M00552001	08714729854418	NovaGold High Performance Guidewire	.018	260	Straight (shapeable)	6	Box 2
M00552011	08714729854425	NovaGold High Performance Guidewire	.018	480	Straight (shapeable)	6	Box 2

WALLSTENT™ Super Stiff Guidewire



Order Number	GTIN	Description	Distal Tip O.D. (in)	Working Length (cm)	Tip Style	Packaging
H965180010	8714729203063	WALLSTENT Super Stiff Guidewire	.035	500	Tapered	Each
H965180011	8714729203070	WALLSTENT Super Stiff Guidewire	.035	500	Tapered	Box 5

RX PRELOADED SPHINCTEROTOMES

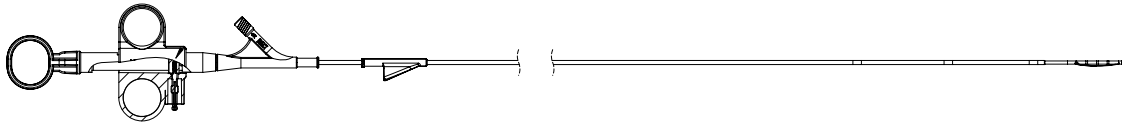

Autotome™ Pro RX Cannulating Sphincterotome							
Order Number	Description	Cut Wire (mm)	Tip Length (Fr)	Distal Tip (Fr)	Recommended Guidewire (in)	Guidewire Tip Style	Packaging
M00584380	Autotome Pro RX 44 Cannulating Sphincterotome	25	5	4.4	0.035	NA	Each
M00584390	Autotome Pro RX 39 Cannulating Sphincterotome	25	5	3.9	0.025	NA	Each
M00584470	Autotome Pro RX 39 25mm Cut Wire, Jag Rev -0.025" x 260cm	25	5	3.9	025/260 Jagwire Revolution Guidewire	Straight	Each
M00584480	Autotome Pro RX 39 25mm Cut Wire, Jag Rev -0.025" x 450cm	25	5	3.9	025/450 Jagwire Revolution Guidewire	Straight	Each

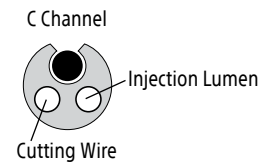
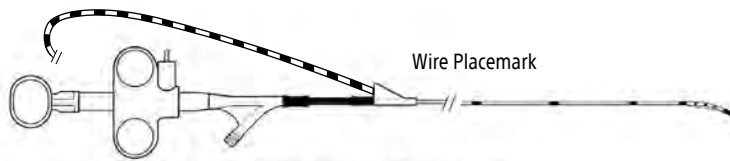

Dreamtome™ RX Cannulating Sphincterotome (Preloaded with Dreamwire™ High Performance Guidewire)							
Order Number	GTIN	Description	Tip Length (mm)	Cut Wire Length (mm)	Preloaded Guidewire (in / cm)	Guidewire Tip Style	Packaging
M00584000	08714729778226	Dreamtome RX 49 Sphincterotome	5	20	.035 / 260 Dreamwire Guidewire	Straight	Each
M00584010	08714729778233	Dreamtome RX 49 Sphincterotome	5	30	.035 / 260 Dreamwire Guidewire	Straight	Each
M00584020	08714729778240	Dreamtome RX 49 Sphincterotome	5	20	.035 / 450 Dreamwire Guidewire	Straight	Each
M00584030	08714729778257	Dreamtome RX 49 Sphincterotome	5	30	.035 / 450 Dreamwire Guidewire	Straight	Each
M00584040	08714729778264	Dreamtome RX 44 Sphincterotome	5	20	.035 / 260 Dreamwire Guidewire	Straight	Each
M00584050	08714729778271	Dreamtome RX 44 Sphincterotome	5	30	.035 / 260 Dreamwire Guidewire	Straight	Each
M00584060	08714729778288	Dreamtome RX 44 Sphincterotome	5	20	.035 / 450 Dreamwire Guidewire	Straight	Each
M00584070	08714729778295	Dreamtome RX 44 Sphincterotome	5	30	.035 / 450 Dreamwire Guidewire	Straight	Each

*Preloaded with straight-tip guidewires only.
Active Cords sold separately (See page 13).

RX PRELOADED SPHINCTEROTOMES (Continued)

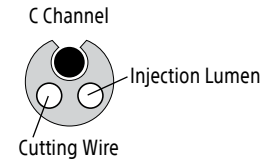
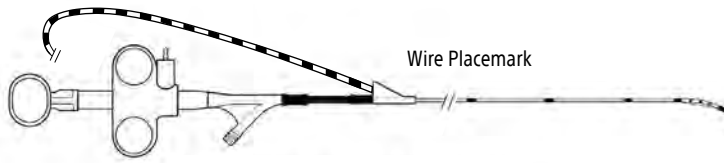

Hydratome™ RX Cannulating Sphincterotome (Preloaded with Hydra Jagwire™ High Performance Guidewire)



Order Number	GTIN	Description	Cut Wire (mm)	Tip Length (mm)	Distal Tip O.D. (Fr)	Preloaded Guidewire (cm)	Guidewire Tip Style	Packaging
M00583000	08714729755159	Hydratome RX 49 Sphincterotome	20	5	4.9	260 Hydra Jagwire Guidewire	Straight	Each
M00583010	08714729755166	Hydratome RX 49 Sphincterotome	30	5	4.9	260 Hydra Jagwire Guidewire	Straight	Each
M00583020	08714729755173	Hydratome RX 49 Sphincterotome	20	5	4.9	450 Hydra Jagwire Guidewire	Straight	Each
M00583030	08714729755180	Hydratome RX 49 Sphincterotome	30	5	4.9	450 Hydra Jagwire Guidewire	Straight	Each
M00583040	08714729755197	Hydratome RX 44 Sphincterotome	20	5	4.4	260 Hydra Jagwire Guidewire	Straight	Each
M00583050	08714729755203	Hydratome RX 44 Sphincterotome	30	5	4.4	260 Hydra Jagwire Guidewire	Straight	Each
M00583060	08714729755210	Hydratome RX 44 Sphincterotome	20	5	4.4	450 Hydra Jagwire Guidewire	Straight	Each
M00583070	08714729755227	Hydratome RX 44 Sphincterotome	30	5	4.4	450 Hydra Jagwire Guidewire	Straight	Each

Active Cords sold separately (See page 13).

RX PRELOADED SPHINCTEROTOMES (Continued)

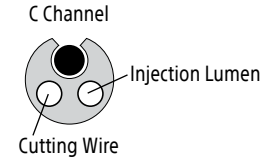
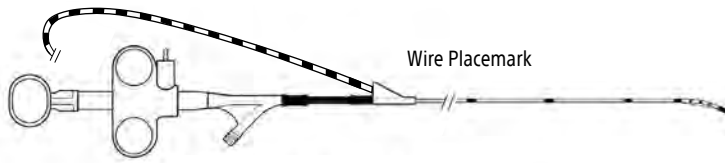

Jagtome™ RX Cannulating Sphincterotome (Preloaded with Jagwire™ High Performance Guidewire)



Order Number	GTIN	Description	Cut Wire (mm)	Tip Length (mm)	Distal Tip O.D. (Fr)	Preloaded Guidewire (in / cm)	Guidewire Tip Style	Packaging
M00573000	08714729776710	Jagtome RX 49 Sphincterotome	20	5	4.9	.035 / 260 Jagwire Guidewire	Straight	Each
M00573010	08714729776727	Jagtome RX 49 Sphincterotome	20	5	4.9	.035 / 450 Jagwire Guidewire	Straight	Each
M00573020	08714729776734	Jagtome RX 49 Sphincterotome	30	5	4.9	.035 / 260 Jagwire Guidewire	Straight	Each
M00573030	08714729776741	Jagtome RX 49 Sphincterotome	30	5	4.9	.035 / 450 Jagwire Guidewire	Straight	Each
M00573040	08714729776659	Jagtome RX 44 Sphincterotome	20	5	4.4	.035 / 260 Jagwire Guidewire	Straight	Each
M00573050	08714729776666	Jagtome RX 44 Sphincterotome	20	5	4.4	.035 / 450 Jagwire Guidewire	Straight	Each
M00573060	08714729776673	Jagtome RX 44 Sphincterotome	30	5	4.4	.035 / 260 Jagwire Guidewire	Straight	Each
M00573070	08714729776543	Jagtome RX 44 Sphincterotome	30	5	4.4	.035 / 450 Jagwire Guidewire	Straight	Each
M00573080	08714729776642	Jagtome RX 39 Sphincterotome	20	5	3.9	.025 / 260 Jagwire Guidewire	Straight	Each
M00573090	08714729776550	Jagtome RX 39 Sphincterotome	20	5	3.9	.025 / 450 Jagwire Guidewire	Straight	Each
M00573100	08714729776536	Jagtome RX 39 Sphincterotome	30	5	3.9	.025 / 260 Jagwire Guidewire	Straight	Each
M00573110	08714729776529	Jagtome RX 39 Sphincterotome	30	5	3.9	.025 / 450 Jagwire Guidewire	Straight	Each

Active Cords sold separately (See page 13).

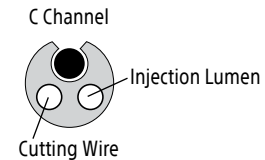
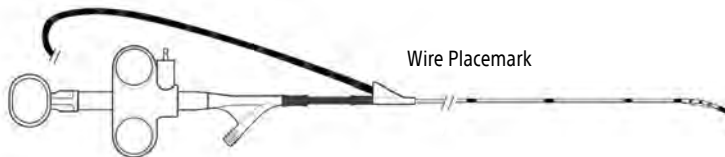

Jagtome Revolution RX Cannulating Sphincterotome (Preloaded with Jagwire Revolution High Performance Guidewire)



Order Number	GTIN	Description	Cut Wire (mm)	Tip Length (mm)	Distal Tip O.D. (Fr)	Preloaded Guidewire (in / cm)	Guidewire Tip Style	Packaging
M00584240	08714729953234	Jagtome Revolution RX 39 Sphincterotome	20	5	3.9	.025/260 Jagwire Revolution Guidewire	Straight	Each
M00584250	08714729953241	Jagtome Revolution RX 39 Sphincterotome	20	5	3.9	.025/450 Jagwire Revolution Guidewire	Straight	Each
M00584260	08714729953258	Jagtome Revolution RX 39 Sphincterotome	30	5	3.9	.025/260 Jagwire Revolution Guidewire	Straight	Each
M00584270	08714729953265	Jagtome Revolution RX 39 Sphincterotome	30	5	3.9	.025/450 Jagwire Revolution Guidewire	Straight	Each

Active Cords sold separately (See page 13).

RX SPHINCTEROTOMES

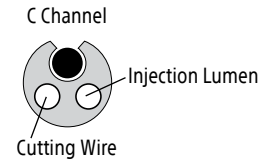

Autotome™ RX Cannulating Sphincterotome							
Order Number	GTIN	Description	Cut Wire (mm)	Tip Length (mm)	Distal Tip O.D. (Fr)	Recommended Guidewire (in)	Packaging
M00545150	08714729415138	Autotome RX 49 Cannulating Sphincterotome	20	5	4.9	.035	Each
M00545160	08714729415152	Autotome RX 49 Cannulating Sphincterotome	30	5	4.9	.035	Each
M00545170	08714729444749	Autotome RX 44 Cannulating Sphincterotome	20	5	4.4	.035	Each
M00545180	08714729444756	Autotome RX 44 Cannulating Sphincterotome	30	5	4.4	.035	Each
M00545190	08714729444763	Autotome RX 39 Cannulating Sphincterotome	20	5	3.9	.025	Each
M00545200	08714729444770	Autotome RX 39 Cannulating Sphincterotome	30	5	3.9	.025	Each

Active Cords sold separately (See page 13).

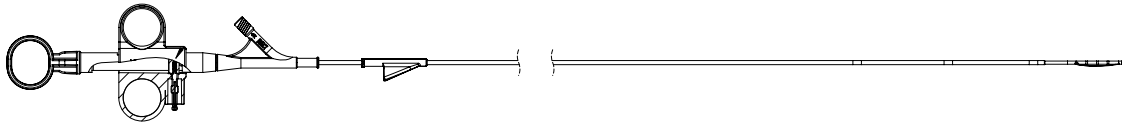

Autotome™ Pro RX Cannulating Sphincterotome							
Order Number	Description	Cut Wire (mm)	Tip Length (Fr)	Distal Tip (Fr)	Recommended Guidewire (in)	Guidewire Tip Style	Packaging
M00584380	Autotome Pro RX 44 Cannulating Sphincterotome	25	5	4.4	.035	N/A	Each
M00584390	Autotome Pro RX 39 Cannulating Sphincterotome	25	5	3.9	.025	N/A	Each

RX Cholangiogram Kits*				
Order Number	Description	Sphincterotome	Guidewire	Accessory
M005XXXX1	Cholangiogram Kit	Autotome or Ultratome™ XL Sphincterotome	Jagwire™ Guidewire	N / A
M005XXXX1	Cholangiogram Kit-Preloaded	Autotome Sphincterotome	Jagwire Guidewire	RX Locking Device

*To order RX Cholangiogram Kits please contact your local Boston Scientific Endoscopy Sales Representative.

RX Needle Knife XL Triple-Lumen Needle Knife							
Order Number	GTIN	Description	Length (cm)	Cut Wire (mm)	Distal Tip O.D. (Fr)	Recommended Guidewire (in)	Packaging
M00545840	08714729283799	RX Needle Knife	200	5	5.5	.035	Each

PRELOADED SPHINCTEROTOMES

TRUEtome™ Jag Cannulating Sphincterotome (Preloaded with Jagwire™ High Performance Guidewire) 

Order Number	GTIN	Description	Tip Length (mm)	Cut Wire Length (mm)	Preloaded Guidewire (in / cm)	Tip O.D. (Fr)	Packaging
M00583080	08714729858621	TRUEtome 39 Sphincterotome	5	20	.025 / 450 Jagwire Guidewire	3.9	Each
M00583090	08714729858638	TRUEtome 44 Sphincterotome	5	20	.025 / 450 Jagwire Guidewire	4.4	Each
M00583100	08714729858645	TRUEtome 44 Sphincterotome	5	20	.035 / 450 Jagwire Guidewire	4.4	Each
M00583110	08714729858652	TRUEtome 44 Sphincterotome	5	20	.035 / Stiff 450 Jagwire Guidewire	4.4	Each
M00583120	08714729858669	TRUEtome 39 Sphincterotome	5	30	.025 / 450 Jagwire Guidewire	3.9	Each
M00583130	08714729858676	TRUEtome 44 Sphincterotome	5	30	.025 / 450 Jagwire Guidewire	4.4	Each
M00583140	08714729858683	TRUEtome 44 Sphincterotome	5	30	.035 / 450 Jagwire Guidewire	4.4	Each
M00583150	08714729858690	TRUEtome 44 Sphincterotome	5	30	.035 / Stiff 450 Jagwire Guidewire	4.4	Each

TRUEtome Hydra Cannulating Sphincterotome (Preloaded with Hydra Jagwire™ High Performance Guidewire) 

M00583160	08714729858706	TRUEtome 44 Sphincterotome	5	20	.035 / 450 Hydra Jagwire Guidewire	4.4	Each
M00583170	08714729858713	TRUEtome 44 Sphincterotome	5	30	.035 / 450 Hydra Jagwire Guidewire	4.4	Each

TRUEtome Dreamwire™ Cannulating Sphincterotome (Preloaded with Dreamwire High Performance Guidewire) 

M00583180	08714729858720	TRUEtome 44 Sphincterotome	5	20	.035 / 260 Dreamwire Guidewire	4.4	Each
M00583190	08714729858737	TRUEtome 44 Sphincterotome	5	20	.035 / 450 Dreamwire Guidewire	4.4	Each
M00583200	08714729858744	TRUEtome 44 Sphincterotome	5	30	.035 / 260 Dreamwire Guidewire	4.4	Each
M00583210	08714729858751	TRUEtome 44 Sphincterotome	5	30	.035 / 450 Dreamwire Guidewire	4.4	Each

*Preloaded with straight-tip guidewires only.
Active Cords sold separately  (See page 13).

TRUEtome Revolution RX Cannulating Sphincterotome (Preloaded with Jagwire Revolution High Performance Guidewire) 

Order Number	GTIN	Description	Tip Length (mm)	Cut Wire Length (mm)	Preloaded Guidewire (in / cm)	Tip O.D. (Fr)	Packaging
M00583260	08714729953272	TRUEtome 39 Sphincterotome	5	20	.025/450 Jagwire Revolution Guidewire	3.9	Each
M00583270	08714729953289	TRUEtome 44 Sphincterotome	5	20	.025/450 Jagwire Revolution Guidewire	4.4	Each
M00583280	08714729953296	TRUEtome 39 Sphincterotome	5	30	.025/450 Jagwire Revolution Guidewire	3.9	Each
M00583290	08714729953302	TRUEtome 44 Sphincterotome	5	30	.025/450 Jagwire Revolution Guidewire	4.4	Each

*Preloaded with straight-tip guidewires only.
Active Cords sold separately  (See page 13).

SPHINCTEROTOMES

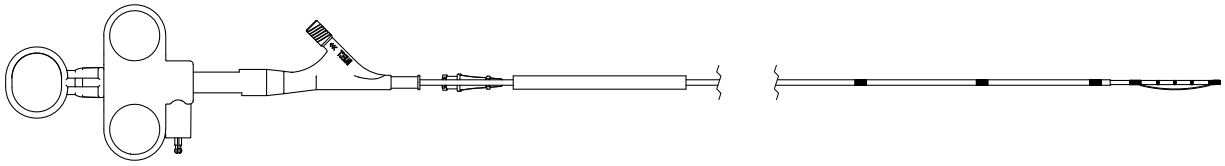

TRUetome™ Cannulating Sphincterotome							
Order Number	GTIN	Description	Cut Wire Length (mm)	Tip Length (mm)	Distal Tip O.D. (Fr)	Recommended Guidewire (in)	Packaging
M00584190	08714729827658	TRUetome 39 Sphincterotome	20	5	3.9	.025	Each
M00584120	08714729827771	TRUetome 39 Sphincterotome	30	5	3.9	.025	Each
M00584170	08714729827634	TRUetome 44 Sphincterotome	20	5	4.4	.035	Each
M00584180	08714729827641	TRUetome 44 Sphincterotome	30	5	4.4	.035	Each
M00584150	08714729827610	TRUetome 49 Sphincterotome	20	5	4.9	.035	Each
M00584160	08714729827627	TRUetome 49 Sphincterotome	30	5	4.9	.035	Each

Active Cords sold separately (See page 13).

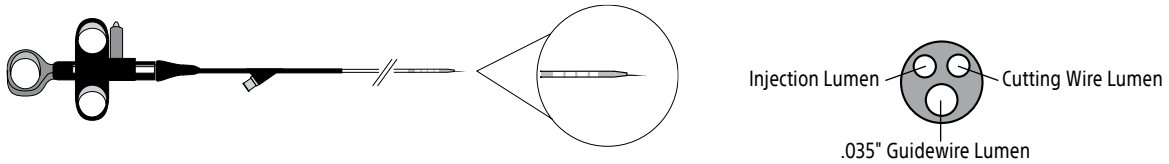

MicroKnife™ XL Triple-Lumen Needle Knife						
Order Number	GTIN	Description	Shaft O.D. (Fr)	Catheter Length (cm)	Recommended Guidewire (in)	Packaging
M00532810	08714729172017	MicroKnife XL Triple-Lumen Needle Knife	7.0 - 5.5	200	.035	Each

Active Cords sold separately (See page 13).

SPHINCTEROTOMES (Continued)

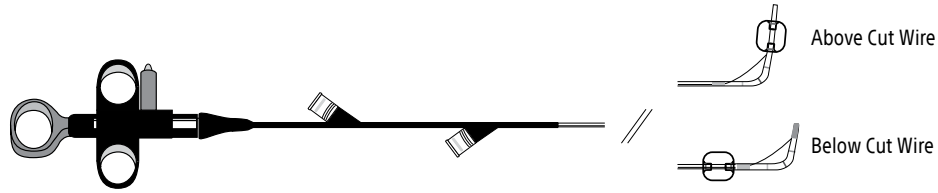

Stonetome™ Stone Removal Device

Order Number	GTIN	Description	Balloon Diameter (mm)	Catheter Length (cm)	Tip Length (mm)	Cut Wire (mm)	Distal Tip O.D. (Fr)	Recommended Guidewire (in)	Packaging
M00535150	08714729146667	Stonetome Device (below cut wire)	11.5	200	5	20	5.5	.035	Each
M00535170	08714729146629	Stonetome Device (below cut wire)	11.5	200	20	20	5.5	.035	Each
M00535190	08714729146612	Stonetome Device (below cut wire)	11.5	200	5	30	5.5	.035	Each
M00535210	08714729146605	Stonetome Device (below cut wire)	11.5	200	20	30	5.5	.035	Each
M00535110	08714729146599	Stonetome Device (above cut wire)	11.5	200	20	20	5.5	.035	Each
M00535130	08714729146575	Stonetome Device (above cut wire)	11.5	200	20	30	5.5	.035	Each

Active Cords sold separately (See page 13).

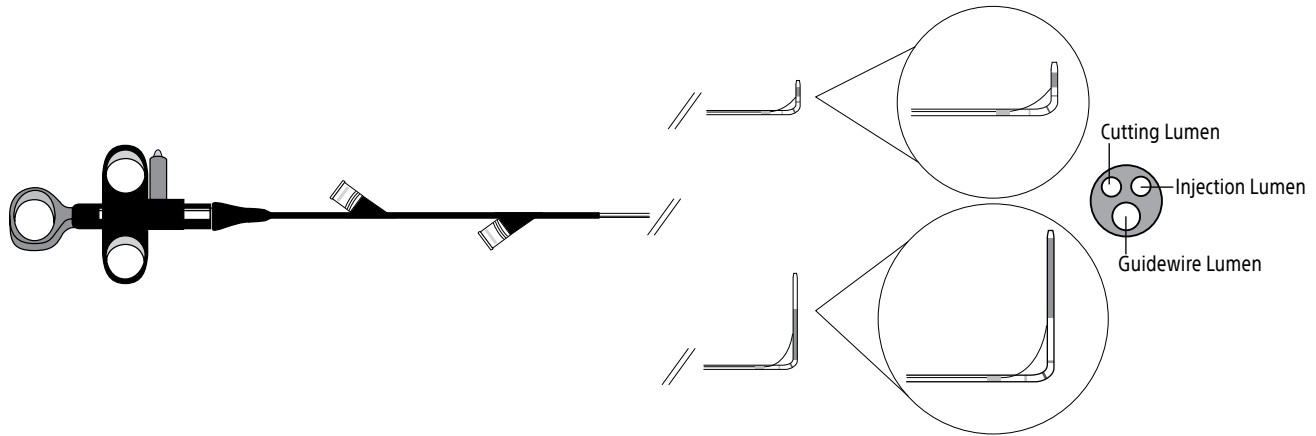

Ultratome™ XL Triple-Lumen Sphincterotome

Order Number	GTIN	Description	Wire Length (mm)	Shaft O.D. (Fr)	Catheter Length (cm)	Tip Length (mm)	Recommended Guidewire (in)	Packaging
M00535900	08714729103257	Ultratome XL Short Nose Sphincterotome	20	5.5	200	5	.035	Each
M00535910	08714729103301	Ultratome XL Long Nose Sphincterotome	20	5.5	200	20	.035	Each
M00535920	08714729103318	Ultratome XL Short Nose Sphincterotome	30	5.5	200	5	.035	Each
M00535930	08714729103349	Ultratome XL Long Nose Sphincterotome	30	5.5	200	20	.035	Each

Active Cords sold separately (See page 13).

SPHINCTEROTOMES (Continued)

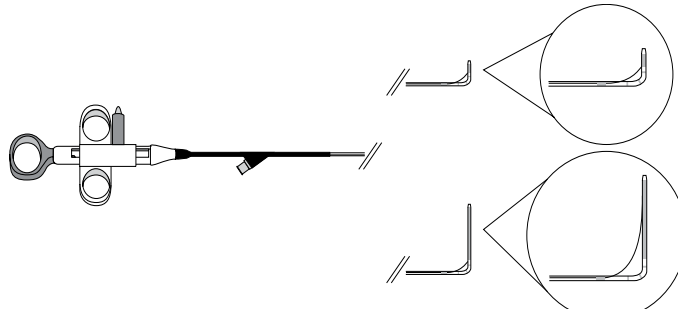

Ultratome™ Double-Lumen Sphincterotome



Order Number	GTIN	Description	Wire Length (mm)	Distal Tip O.D.		Catheter Length (cm)	Tip Length (mm)	Recommended Guidewire (in)	Packaging
				(mm)	(Fr)				
M00530800	08714729163664	Ultratome Short Nose Sphincterotome	20	1.8	5.5	200	5	.035	Each
M00530810	08714729183143	Ultratome Long Nose Sphincterotome	20	1.8	5.5	200	20	.035	Each
M00530820	08714729193418	Ultratome Short Nose Sphincterotome	30	1.8	5.5	200	5	.035	Each
M00530830	08714729193425	Ultratome Long Nose Sphincterotome	30	1.8	5.5	200	20	.035	Each

Active Cords sold separately (See page 13).

RX CANNULAS

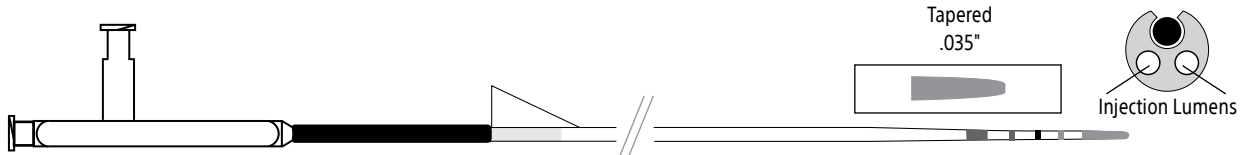

Rapid Exchange XL Cannula



Order Number	GTIN	Description	Working Length (cm)	Tip Style	Recommended Guidewire (in)	Packaging
M00545820	08714729301905	Rapid Exchange XL Cannula	195	Tapered	.035	Each

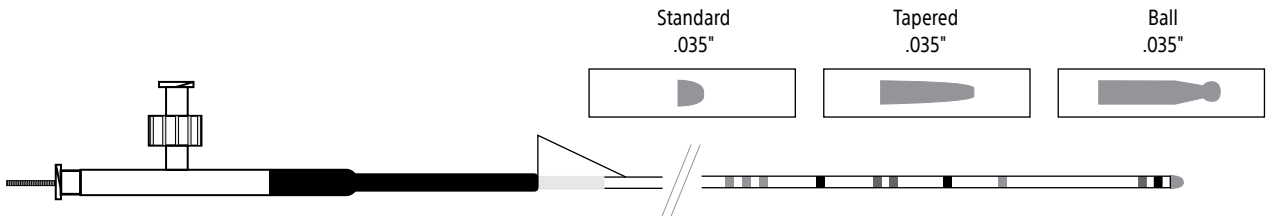

RX ERCP Cannulas



Order Number	GTIN	Description	Working Length (cm)	Recommended Guidewire (in)	Packaging
M00545760	08714729268642	RX ERCP Cannula Standard Tip	210	.035	Each
M00545770	08714729268659	RX ERCP Cannula Tapered Tip	210	.035	Each
M00545780	08714729268673	RX ERCP Cannula Ball Tip	210	.035	Each

CANNULAS

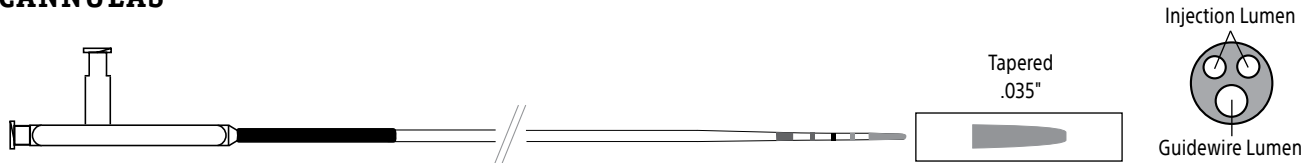

Tandem™ XL Triple-Lumen ERCP Cannula								
Order Number	GTIN	Distal Tip O.D.		Catheter Size (Fr)	Working Length (cm)	Tip Style	Recommended Guidewire (in)	Packaging
		(Fr)	(mm)					
M00535700	08714729146636	5.5	1.8	7.0 – 5.5	200	Tapered	.035	Each

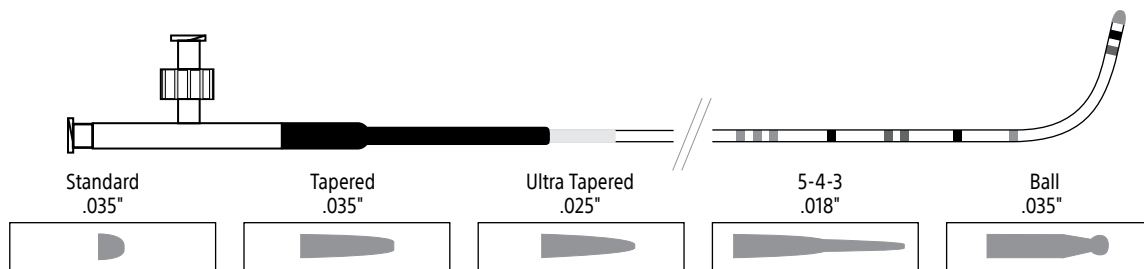

Contour™ ERCP Cannulas								
Order Number	GTIN	Description	Distal Tip O.D.		Working Length (cm)	Tip Style	Recommended Guidewire (in)	Packaging
			(Fr)	(mm)				
M00530850	08714729099789	Contour ERCP Cannula	5	1.7	210	Standard	.035	Each
M00530860	08714729099819	Contour ERCP Cannula	5	1.7	210	Tapered	.035	Each
M00530870	08714729099826	Contour ERCP Cannula	5	1.7	210	Ultra Tapered	.025	Each
M00530880	08714729099833	Contour ERCP Cannula	5	1.7	210	5-4-3	.018	Each
M00530890	08714729099840	Contour ERCP Cannula	5	1.7	210	Ball Tip	.035	Each

ACCESSORIES

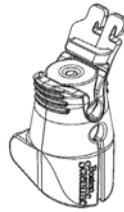

AutoCap™ RX Integrated Biopsy Cap & Guidewire Locking Device



Order Number	GTIN	Description	Packaging
M00545101	08714729994695	AutoCap RX Olympus Compatible (TJF-160, TJF-180, TJF-190 and JF-260V Series Duodenoscopes)	Box 10
M00545121	00191506040215	AutoCap RX Fujifilm Scope Compatible	Box 10
M00545131	00191506000745	AutoCap RX EXALT™ Model D Compatible	Box 10

RX Locking Devices and Biopsy Cap Systems



Order Number	GTIN	Description	Packaging
M00545211	08714729440604	RX Locking Device Olympus™ / FujiFilm™ Brand Endoscope Compatible	Box 10
M00545261	08714729296614	RX Locking Device and Biopsy Cap System – Olympus / FujiFilm G5 Series Brand Endoscope Compatible	Box 10
M00545271	08714729296621	RX Locking Device and Biopsy Cap System – Pentax™ Brand Endoscope Compatible	Box 10
M00545281	08714729296638	RX Locking Device and Biopsy Cap System – FujiFilm Type 3 Series Brand Endoscope Compatible	Box 10

Active Cords (Fit Boston Scientific Endoscopy Sphincterotome)

Order Number	Description	Packaging
M00561250	Active Cord, Fits Olympus Brand Generator	Each
M00561270	Active Cord, Fits Endostat™, Endostat II and Endostat III Generators, Bovie™, Valleylab™, Aspen Labs™, and ERBE™ Brand Generators	Each

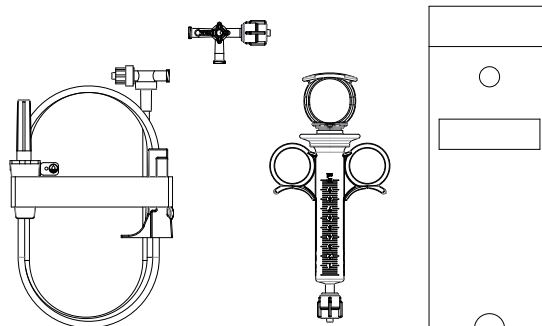

Rapid Refill Continuous Injection System



Order Number	GTIN	Description	Packaging
M00566001	08714729285151	Rapid Refill Continuous Injection System	Box 10

► Biliary Stricture and Stone Management



Biliary and Pancreatic Stents

Biliary Metal Stents

- WallFlex™ Biliary PLUS RX Fully Covered Stent System 14
- WallFlex Biliary RX Fully Covered Stent System RMV 14
- WallFlex Biliary RX Fully Covered Stent System 14
- WallFlex Biliary RX Partially Covered Stent System 15
- WallFlex Biliary RX Uncovered Stent System 15
- Epic™ Biliary Endoscopic Stent System 16

Biliary Plastic Stents

- Advanix Duodenal Bend Preloaded RX Stent Systems 17
- Advanix™ Center Bend Preloaded RX Stent Systems 17
- Advanix Duodenal Bend - Single Stent 18
- Advanix Center Bend - Single Stent 18
- Advanix Double Pigtail - Single Stent 19
- NaviFlex™ RX Delivery System 19
- RX Duodenal Bend Biliary Stent with RX Delivery System ... 20
- Flexima™ Duodenal Bend Biliary Stent with Delivery System .. 20
- Flexima Single Pigtail Nasobiliary Catheter 21

Pancreatic Plastic Stents

- Advanix Pancreatic Stent Kit - Straight, No Leading Barb and Leading Barb 22
- Advanix Pancreatic Stent Kit - Pigtail, Leading Barb and No Leading Barb 22
- Advanix Pancreatic Stent - Straight, No Leading Barb 23
- Advanix Pancreatic Stent - Straight, Leading Barb 24
- Advanix Pancreatic Stent - Pigtail, No Leading Barb 25
- Advanix Pancreatic Stent - Pigtail, Leading Barb 26
- NaviFlex RX Pancreatic Delivery System & NaviFlex Pushers.... 27

Biliary Stone Management

RX Stone Management

- Extractor™ Pro RX Retrieval Balloon Catheter – Distal Injection ... 28
- Extractor Pro RX Retrieval Balloon Catheter – Proximal Injection.. 28
- Extractor Pro RX-S Retrieval Balloon Catheter – Distal Injection .. 28
- Extractor Pro RX-S Retrieval Balloon Catheter – Proximal Injection.. 28

Stone Management

- Extractor Pro XL Retrieval Balloon Catheter – Distal Injection... 29
- Extractor Pro XL Retrieval Balloon Catheter – Proximal Injection.. 29
- Trapezoid™ RX Wireguided Retrieval Baskets 29

CRE™ Wireguided Balloon Dilatation Catheters

- CRE PRO Wireguided Balloon Dilatation Catheters 30
- CRE RX Biliary Balloon Dilatation Catheters 30

Biliary Stricture Management

Pancreaticobiliary Ablation

- Habib™ EndoHPB Bipolar Radiofrequency Catheter 31

RX Cytology

- RX Cytology Brush Wireguided Cytology Brush 32

RX Dilatation

- Hurricane™ RX Biliary Balloon Dilatation Catheter 31

RX Accessories

- Encore™ 26 Inflation Device 32

► Biliary Metal Stents

WALLFLEX™ BILIARY RX STENTS



 Magnetic Resonance Conditional¹

WallFlex Biliary PLUS RX Fully Covered Stent System*



Order Number	GTIN	Diameter (mm)	Length (mm)	Catheter Diameter (Fr / mm)	Guidewire Diameter (in / mm)	Working Length (cm)	Packaging
M00547500	191506044480	8	60	8.5 / 2.83	.035 / .89	194	Each
M00547510	191506044503	8	80	8.5 / 2.83	.035 / .89	194	Each
M00547520	191506044510	8	100	9.0 / 3.0	.035 / .89	194	Each
M00547530	191506044466	10	40	8.5 / 2.83	.035 / .89	194	Each
M00547540	191506044527	10	60	8.5 / 2.83	.035 / .89	194	Each
M00547550	191506044497	10	80	8.5 / 2.83	.035 / .89	194	Each
M00547560	191506044473	10	100	9.0 / 3.0	.035 / .89	194	Each

*Compatible with Boston Scientific .035" guidewires, including Dreamwire™ High Performance Guidewire (See page 1).

Hydra Jagwire® Guidewire Stiff Shaft .035" (.89mm)-260cm | M00556021: Straight Dream Tip

Hydra Jagwire Guidewire Stiff Shaft .035" (.89mm)-450cm | M00556061: Straight Dream Tip; M00556071: Angled Dream Tip

¹Product with this symbol may be used in Magnetic Resonance environment according to the conditions described in Instructions for Use.



Fully Covered

WallFlex Biliary RX Fully Covered Stent System RMV*



Order Number	GTIN	Diameter (mm)	Length (mm)	Catheter Diameter (Fr / mm)	Guidewire Diameter (in / mm)	Working Length (cm)	Packaging
M00570340	08714729953159	8	60	8.5 / 2.83	.035 / .89	194	Each
M00570350	08714729953166	8	80	8.5 / 2.83	.035 / .89	194	Each
M00570360	08714729953173	10	40	8.5 / 2.83	.035 / .89	194	Each
M00570370	08714729953180	10	60	8.5 / 2.83	.035 / .89	194	Each
M00570380	08714729953197	10	80	8.5 / 2.83	.035 / .89	194	Each

*Compatible with Boston Scientific .035" guidewires, including Dreamwire™ High Performance Guidewire (See page 1).

Hydra Jagwire® Guidewire Stiff Shaft .035" (.89mm)-260cm | M00556021: Straight Dream Tip

Hydra Jagwire Guidewire Stiff Shaft .035" (.89mm)-450cm | M00556061: Straight Dream Tip; M00556071: Angled Dream Tip

¹Product with this symbol may be used in Magnetic Resonance environment according to the conditions described in Instructions for Use.

WallFlex Biliary RX Fully Covered Stent System*



Order Number	GTIN	Diameter (mm)	Length (mm)	Catheter Diameter (Fr / mm)	Guidewire Diameter (in / mm)	Working Length (cm)	Packaging
M00547460	00191506026202	8	100	9.0 / 3.0	.035 / .89	194	Each
M00547480	00191506026226	10	100	9.0 / 3.0	.035 / .89	194	Each

*Indicated for the palliative treatment of biliary strictures produced by malignant neoplasms and relief of malignant biliary obstruction prior to surgery.

Hydra Jagwire® Guidewire Stiff Shaft .035" (.89mm)-260cm | M00556021: Straight Dream Tip

Hydra Jagwire Guidewire Stiff Shaft .035" (.89mm)-450cm | M00556061: Straight Dream Tip; M00556071: Angled Dream Tip

¹Product with this symbol may be used in Magnetic Resonance environment according to the conditions described in Instructions for Use.

► Biliary Metal Stents



WallFlex Biliary RX Partially Covered Stent System*

Order Number	GTIN	Diameter (mm)	Length (mm)	Covered Length (mm) (PC Only)	Catheter Diameter (Fr / mm)	Guidewire Diameter (in / mm)	Working Length (cm)	Packaging
M00570700	08714729759294	8	60	48	8.5 / 2.83	.035 / .89	194	Each
M00570710	08714729759300	8	80	68	8.5 / 2.83	.035 / .89	194	Each
M00547420	00191506026165	8	100	88	9.0 / 3.0	.035 / .89	194	Each
M00570720	08714729759317	10	40	28	8.5 / 2.83	.035 / .89	194	Each
M00570730	08714729759324	10	60	48	8.5 / 2.83	.035 / .89	194	Each
M00570740	08714729759331	10	80	68	8.5 / 2.83	.035 / .89	194	Each
M00547440	00191506026189	10	100	88	9.0 / 3.0	.035 / .89	194	Each

*Compatible with Boston Scientific .035" guidewires, including Dreamwire High Performance Guidewire (See page 1).

Hydra Jagwire® Guidewire Stiff Shaft .035" (.89mm)-260cm | M00556021: Straight Dream Tip

Hydra Jagwire Guidewire Stiff Shaft .035" (.89mm)-450cm | M00556061: Straight Dream Tip; M00556071: Angled Dream Tip

†Product with this symbol may be used in Magnetic Resonance environment according to the conditions described in Instructions for Use.



WallFlex Biliary RX Uncovered Stent System*

Order Number	GTIN	Diameter (mm)	Length (mm)	Catheter Diameter (Fr / mm)	Guidewire Diameter (in / mm)	Working Length (cm)	Packaging
M00570600	08714729759249	8	40	8.0 / 2.67	.035 / .89	194	Each
M00570610	08714729759256	8	60	8.0 / 2.67	.035 / .89	194	Each
M00570620	08714729759263	8	80	8.0 / 2.67	.035 / .89	194	Each
M00570630	08714729759270	8	100	8.0 / 2.67	.035 / .89	194	Each
M00570890	08714729765332	10	40	8.0 / 2.67	.035 / .89	194	Each
M00570640	08714729756231	10	60	8.0 / 2.67	.035 / .89	194	Each
M00570650	08714729758150	10	80	8.0 / 2.67	.035 / .89	194	Each
M00570660	08714729759287	10	100	8.0 / 2.67	.035 / .89	194	Each

*Compatible with Boston Scientific .035" guidewires, including Dreamwire High Performance Guidewire (See page 1).

Hydra Jagwire® Guidewire Stiff Shaft .035" (.89mm)-260cm | M00556021: Straight Dream Tip

Hydra Jagwire Guidewire Stiff Shaft .035" (.89mm)-450cm | M00556061: Straight Dream Tip; M00556071: Angled Dream Tip

†Product with this symbol may be used in Magnetic Resonance environment according to the conditions described in Instructions for Use.

► Biliary Metal Stents

EPIC™ BILIARY ENDOSCOPIC STENT SYSTEM



 Magnetic Resonance Conditional¹

Epic Biliary Endoscopic Stent

Order Number	GTIN	Description	Stent Diameter (mm)	Stent Length (mm)	Catheter Diameter (Fr)	Guidewire Diameter (in)	Catheter Working Length (cm)	Packaging
M00572230	08714729896852	Epic Biliary Stent	6	40	6	0.035	220	Each
M00572240	08714729896869	Epic Biliary Stent	6	60	6	0.035	220	Each
M00572250	08714729896876	Epic Biliary Stent	6	80	6	0.035	220	Each
M00572260	08714729896883	Epic Biliary Stent	6	100	6	0.035	220	Each
M00572270	08714729896890	Epic Biliary Stent	8	40	6	0.035	220	Each
M00572280	08714729896906	Epic Biliary Stent	8	60	6	0.035	220	Each
M00572290	08714729896913	Epic Biliary Stent	8	80	6	0.035	220	Each
M00572300	08714729896920	Epic Biliary Stent	8	100	6	0.035	220	Each
M00572310	08714729896937	Epic Biliary Stent	10	40	6	0.035	220	Each
M00572320	08714729896944	Epic Biliary Stent	10	60	6	0.035	220	Each
M00572330	08714729896951	Epic Biliary Stent	10	80	6	0.035	220	Each
M00572340	08714729896968	Epic Biliary Stent	10	100	6	0.035	220	Each

¹Product with this symbol may be used in Magnetic Resonance environment according to the conditions described in Instructions for Use.

► Biliary Plastic Stents

ADVANIX™ BILIARY STENTS



MR Magnetic Resonance Safe

Advanix Duodenal Bend Preloaded RX Stent Systems



Order Number	GTIN	Description	Stent Diameter (Fr)	Length (cm) Barb to Barb	Packaging
M00534200	08714729787297	Duodenal Bend	7	5	Each
M00534210	08714729787303	Duodenal Bend	7	7	Each
M00534220	08714729787310	Duodenal Bend	7	9	Each
M00534230	08714729787327	Duodenal Bend	7	12	Each
M00534240	08714729787334	Duodenal Bend	7	15	Each
M00534250	08714729787341	Duodenal Bend	7	18	Each
M00534260	08714729787358	Duodenal Bend	8.5	5	Each
M00534270	08714729787365	Duodenal Bend	8.5	7	Each
M00534280	08714729787372	Duodenal Bend	8.5	9	Each
M00534290	08714729787389	Duodenal Bend	8.5	12	Each
M00534300	08714729787396	Duodenal Bend	8.5	15	Each
M00534310	08714729787402	Duodenal Bend	8.5	18	Each
M00534320	08714729787419	Duodenal Bend	10	5	Each
M00534330	08714729787426	Duodenal Bend	10	7	Each
M00534340	08714729787433	Duodenal Bend	10	9	Each
M00534350	08714729787440	Duodenal Bend	10	12	Each
M00534360	08714729787457	Duodenal Bend	10	15	Each
M00534370	08714729787464	Duodenal Bend	10	18	Each

Scope Compatibility: 7Fr and 8.5Fr stents require a 3.2mm working channel; 10Fr stents require a 4.2mm working channel.



MR Magnetic Resonance Safe

Advanix Center Bend Preloaded RX Stent Systems



Order Number	GTIN	Description	Stent Diameter (Fr)	Length (cm) Barb to Barb	Packaging
M00534560	08714729787112	Center Bend	7	5	Each
M00534570	08714729787129	Center Bend	7	7	Each
M00534580	08714729787136	Center Bend	7	9	Each
M00534590	08714729787143	Center Bend	7	12	Each
M00534600	08714729787150	Center Bend	7	15	Each
M00534610	08714729787167	Center Bend	7	18	Each
M00534620	08714729787174	Center Bend	8.5	5	Each
M00534630	08714729787181	Center Bend	8.5	7	Each
M00534640	08714729787198	Center Bend	8.5	9	Each
M00534650	08714729787204	Center Bend	8.5	12	Each
M00534660	08714729787211	Center Bend	8.5	15	Each
M00534670	08714729787228	Center Bend	8.5	18	Each
M00534680	08714729787235	Center Bend	10	5	Each
M00534690	08714729787242	Center Bend	10	7	Each
M00534700	08714729787259	Center Bend	10	9	Each
M00534710	08714729787266	Center Bend	10	12	Each
M00534720	08714729787273	Center Bend	10	15	Each
M00534730	08714729787280	Center Bend	10	18	Each

Scope Compatibility: 7Fr and 8.5Fr stents require a 3.2mm working channel; 10Fr stents require a 4.2mm working channel.

► Biliary Plastic Stents

ADVANIX™ BILIARY STENTS (Continued)



MR Magnetic Resonance Safe

Advanix Duodenal Bend - Single Stent



Order Number	GTIN	Description	Stent Diameter (Fr)	Length (cm) Barb to Barb	Packaging
M00532870	08714729786788	Duodenal Bend	7	5	Each
M00532880	08714729786795	Duodenal Bend	7	7	Each
M00532890	08714729786801	Duodenal Bend	7	9	Each
M00532900	08714729786818	Duodenal Bend	7	12	Each
M00532910	08714729786825	Duodenal Bend	7	15	Each
M00532920	08714729786832	Duodenal Bend	7	18	Each
M00532930	08714729786849	Duodenal Bend	8.5	5	Each
M00532940	08714729786856	Duodenal Bend	8.5	7	Each
M00532950	08714729786863	Duodenal Bend	8.5	9	Each
M00532960	08714729786870	Duodenal Bend	8.5	12	Each
M00532970	08714729786887	Duodenal Bend	8.5	15	Each
M00532980	08714729786894	Duodenal Bend	8.5	18	Each
M00532990	08714729786900	Duodenal Bend	10	5	Each
M00533000	08714729786917	Duodenal Bend	10	7	Each
M00533010	08714729786924	Duodenal Bend	10	9	Each
M00533020	08714729786931	Duodenal Bend	10	12	Each
M00533030	08714729786948	Duodenal Bend	10	15	Each
M00533040	08714729786955	Duodenal Bend	10	18	Each

Scope Compatibility: 7Fr and 8.5Fr stents require a 3.2mm working channel; 10Fr stents require a 4.2mm working channel.



MR Magnetic Resonance Safe

Advanix Center Bend - Single Stent



Order Number	GTIN	Description	Stent Diameter (Fr)	Length (cm) Barb to Barb	Packaging
M00533230	08714729786603	Center Bend	7	5	Each
M00533240	08714729786610	Center Bend	7	7	Each
M00533250	08714729786627	Center Bend	7	9	Each
M00533260	08714729786634	Center Bend	7	12	Each
M00533270	08714729786641	Center Bend	7	15	Each
M00533280	08714729786658	Center Bend	7	18	Each
M00533290	08714729786665	Center Bend	8.5	5	Each
M00533300	08714729786672	Center Bend	8.5	7	Each
M00533310	08714729786689	Center Bend	8.5	9	Each
M00533320	08714729786696	Center Bend	8.5	12	Each
M00533330	08714729786702	Center Bend	8.5	15	Each
M00533340	08714729786719	Center Bend	8.5	18	Each
M00533350	08714729786726	Center Bend	10	5	Each
M00533360	08714729786733	Center Bend	10	7	Each
M00533370	08714729786740	Center Bend	10	9	Each
M00533380	08714729786757	Center Bend	10	12	Each
M00533390	08714729786764	Center Bend	10	15	Each
M00533400	08714729786771	Center Bend	10	18	Each

Scope Compatibility: 7Fr and 8.5Fr stents require a 3.2mm working channel; 10Fr stents require a 4.2mm working channel.

► Biliary Plastic Stents

ADVANIX™ BILIARY STENTS (Continued)

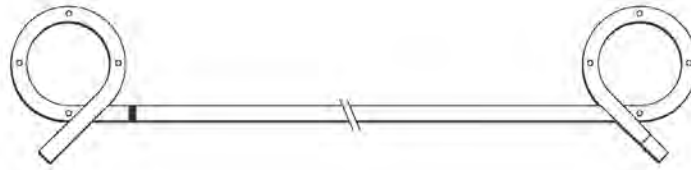

MR Magnetic Resonance Safe

Advanix Double Pigtail - Single Stent



Order Number	GTIN	Description	Stent Diameter (Fr)	Length (cm) Between Pigtails	Packaging
M00532160	08714729786962	Double Pigtail	7	3	Each
M00532180	08714729786979	Double Pigtail	7	5	Each
M00532190	08714729786986	Double Pigtail	7	7	Each
M00532210	08714729786993	Double Pigtail	7	10	Each
M00532220	08714729787006	Double Pigtail	7	12	Each
M00532230	08714729787013	Double Pigtail	7	15	Each
M00532240	08714729787020	Double Pigtail	10	3	Each
M00532260	08714729787037	Double Pigtail	10	5	Each
M00532270	08714729787044	Double Pigtail	10	7	Each
M00532290	08714729787051	Double Pigtail	10	10	Each
M00532300	08714729787068	Double Pigtail	10	12	Each
M00532310	08714729787075	Double Pigtail	10	15	Each

Scope Compatibility: 7Fr and 8.5Fr stents require a 3.2mm working channel; 10Fr stents require a 4.2mm working channel.

NAVIFLEX™ RX DELIVERY SYSTEM

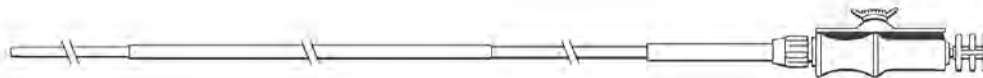

NaviFlex RX Delivery System*



Order Number	GTIN	Description	Catheter Diameter (Fr)	Length (cm)	Packaging
M00533560	08714729787082	RX Delivery System	7	202.5	Each
M00533570	08714729787099	RX Delivery System	8.5	202.5	Each
M00533580	08714729787105	RX Delivery System	10	202.5	Each

*Compatible with Advanix Biliary Stents.

► Biliary Plastic Stents

DUODENAL BEND STENTS

MR Magnetic Resonance Safe

RX Duodenal Bend Biliary Stent with RX Delivery System



Order Number	GTIN	Description	O.D. (Fr)	Length (cm) Barb to Barb	Recommended Guidewire (in)	Packaging
M00545550	08714729337850	Duodenal Bend Biliary Stent with RX Delivery System	7	5	.035	Each
M00545560	08714729337867	Duodenal Bend Biliary Stent with RX Delivery System	7	7	.035	Each
M00545570	08714729337874	Duodenal Bend Biliary Stent with RX Delivery System	7	10	.035	Each
M00545580	08714729337881	Duodenal Bend Biliary Stent with RX Delivery System	7	12	.035	Each
M00545590	08714729337898	Duodenal Bend Biliary Stent with RX Delivery System	7	15	.035	Each
M00545650	08714729252221	Duodenal Bend Biliary Stent with RX Delivery System	8.5	5	.035	Each
M00545660	08714729301837	Duodenal Bend Biliary Stent with RX Delivery System	8.5	7	.035	Each
M00545670	08714729301844	Duodenal Bend Biliary Stent with RX Delivery System	8.5	10	.035	Each
M00545680	08714729301851	Duodenal Bend Biliary Stent with RX Delivery System	8.5	12	.035	Each
M00545690	08714729301868	Duodenal Bend Biliary Stent with RX Delivery System	8.5	15	.035	Each
M00545600	08714729337904	Duodenal Bend Biliary Stent with RX Delivery System	10	5	.035	Each
M00545610	08714729337911	Duodenal Bend Biliary Stent with RX Delivery System	10	7	.035	Each
M00545620	08714729337928	Duodenal Bend Biliary Stent with RX Delivery System	10	10	.035	Each
M00545630	08714729301813	Duodenal Bend Biliary Stent with RX Delivery System	10	12	.035	Each
M00545640	08714729301820	Duodenal Bend Biliary Stent with RX Delivery System	10	15	.035	Each
M00545700	08714729301875	Duodenal Bend Biliary Stent with RX Delivery System	11.5	5	.035	Each
M00545710	08714729301882	Duodenal Bend Biliary Stent with RX Delivery System	11.5	7	.035	Each
M00545720	08714729301899	Duodenal Bend Biliary Stent with RX Delivery System	11.5	10	.035	Each
M00545730	08714729337942	Duodenal Bend Biliary Stent with RX Delivery System	11.5	12	.035	Each
M00545740	08714729337959	Duodenal Bend Biliary Stent with RX Delivery System	11.5	15	.035	Each



MR Magnetic Resonance Safe

Flexima™ Duodenal Bend Biliary Stent with Delivery System



Order Number	GTIN	O.D. (Fr)	Length (cm) Barb to Barb	Recommended Guidewire (in)	Packaging
M00539200	08714729337362	7	5	.035	Each
M00539210	08714729162520	7	7	.035	Each
M00539220	08714729162537	7	10	.035	Each
M00539230	08714729162544	7	12	.035	Each
M00539240	08714729162551	7	15	.035	Each
M00539250	08714729162568	8.5	5	.035	Each
M00539260	08714729162575	8.5	7	.035	Each
M00539270	08714729162582	8.5	10	.035	Each
M00539280	08714729162599	8.5	12	.035	Each
M00539290	08714729162605	8.5	15	.035	Each
M00539300	08714729162612	10	5	.035	Each
M00539310	08714729162629	10	7	.035	Each
M00539320	08714729162636	10	10	.035	Each
M00539330	08714729162643	10	12	.035	Each
M00539340	08714729162650	10	15	.035	Each
M00539350	08714729162667	11.5	5	.035	Each
M00539360	08714729162674	11.5	7	.035	Each
M00539370	08714729162681	11.5	10	.035	Each
M00539380	08714729162698	11.5	12	.035	Each
M00539390	08714729162704	11.5	15	.035	Each

► Biliary Plastic Stents

PIGTAIL STENTS

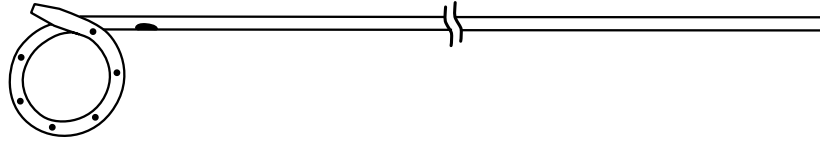

MR Magnetic Resonance Safe



Flexima™ Single Pigtail Nasobiliary Catheter*

Order Number	GTIN	O.D. (Fr)	Working Length (cm)	Packaging
M00540110	08714729337379	5	250	Each
M00540120	08714729337386	6	250	Each
M00540130	08714729337393	7.5	250	Each
M00540140	08714729337409	8.5	250	Each

*Recommended Guidewire .035" Dreamwire™ High Performance Guidewire, Order #5614, [▶](#) (See page 1).

Pancreatic Plastic Stents

ADVANIX™ PANCREATIC STENTS



 Magnetic Resonance Conditional¹

Advanix Pancreatic Stent Kit - Straight, No Leading Barb and Leading Barb



Order Number	GTIN	Description	Diameter (Fr)	Length (cm)	Packaging
M00537460	08714729856245	Straight Stent - No Leading Barb	4	3	Each
M00537470	08714729856252	Straight Stent - No Leading Barb	4	4	Each
M00537480	08714729856269	Straight Stent - No Leading Barb	4	5	Each
M00537490	08714729862956	Straight Stent - No Leading Barb	4	7	Each
M00537500	08714729856276	Straight Stent - No Leading Barb	5	3	Each
M00537510	08714729856283	Straight Stent - No Leading Barb	5	4	Each
M00537520	08714729856290	Straight Stent - No Leading Barb	5	5	Each
M00537530	08714729856306	Straight Stent - No Leading Barb	5	7	Each
M00537540	08714729856313	Straight Stent - Leading Barb	5	3	Each
M00537550	08714729856320	Straight Stent - Leading Barb	5	4	Each
M00537560	08714729856337	Straight Stent - Leading Barb	5	5	Each

¹Product with this symbol may be used in Magnetic Resonance environment according to the conditions described in Directions for Use.

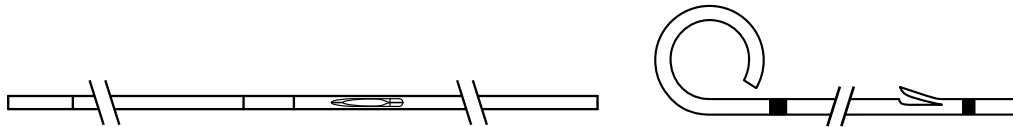

 Magnetic Resonance Conditional¹

Advanix Pancreatic Stent Kit - Pigtail, Leading Barb and No Leading Barb



Order Number	GTIN	Description	Diameter (Fr)	Length (cm)	Packaging
M00537350	08714729856344	Single Pigtail Stent - No Leading Barb	4	3	Each
M00537360	08714729856351	Single Pigtail Stent - No Leading Barb	4	4	Each
M00537370	08714729856368	Single Pigtail Stent - No Leading Barb	4	5	Each
M00537380	08714729856375	Single Pigtail Stent - No Leading Barb	4	7	Each
M00537390	08714729856382	Single Pigtail Stent - No Leading Barb	5	3	Each
M00537400	08714729856399	Single Pigtail Stent - No Leading Barb	5	4	Each
M00537410	08714729856405	Single Pigtail Stent - No Leading Barb	5	5	Each
M00537420	08714729856412	Single Pigtail Stent - No Leading Barb	5	7	Each
M00537430	08714729856429	Single Pigtail Stent - Leading Barb	5	3	Each
M00537440	08714729856436	Single Pigtail Stent - Leading Barb	5	4	Each
M00537450	08714729856443	Single Pigtail Stent - Leading Barb	5	5	Each

¹Product with this symbol may be used in Magnetic Resonance environment according to the conditions described in Directions for Use.

Pancreatic Plastic Stents

ADVANIX™ PANCREATIC STENTS (Continued)



 Magnetic Resonance Conditional¹

Advanix Pancreatic Stent - Straight, No Leading Barb



Order Number	GTIN	Description	Diameter (Fr)	Length (cm)	Packaging
M00536000	08714729857686	Straight - No Leading Barb	3	2	Each
M00536010	08714729857693	Straight - No Leading Barb	3	3	Each
M00536020	08714729857709	Straight - No Leading Barb	3	4	Each
M00536030	08714729857716	Straight - No Leading Barb	3	5	Each
M00536040	08714729857723	Straight - No Leading Barb	3	6	Each
M00536050	08714729857730	Straight - No Leading Barb	3	7	Each
M00536060	08714729857747	Straight - No Leading Barb	3	8	Each
M00536070	08714729857754	Straight - No Leading Barb	3	9	Each
M00536080	08714729857761	Straight - No Leading Barb	3	10	Each
M00536090	08714729857778	Straight - No Leading Barb	3	11	Each
M00536100	08714729857785	Straight - No Leading Barb	3	12	Each
M00536110	08714729857792	Straight - No Leading Barb	3	13	Each
M00536120	08714729857068	Straight - No Leading Barb	4	2	Each
M00536130	08714729857075	Straight - No Leading Barb	4	3	Each
M00536140	08714729857082	Straight - No Leading Barb	4	4	Each
M00536150	08714729857099	Straight - No Leading Barb	4	5	Each
M00536160	08714729857105	Straight - No Leading Barb	4	6	Each
M00536170	08714729857112	Straight - No Leading Barb	4	7	Each
M00536180	08714729857129	Straight - No Leading Barb	4	8	Each
M00536190	08714729857136	Straight - No Leading Barb	4	9	Each
M00536200	08714729857143	Straight - No Leading Barb	4	10	Each
M00536210	08714729857150	Straight - No Leading Barb	4	11	Each
M00536220	08714729857167	Straight - No Leading Barb	4	12	Each
M00536230	08714729857174	Straight - No Leading Barb	4	13	Each
M00536240	08714729857181	Straight - No Leading Barb	5	2	Each
M00536250	08714729857198	Straight - No Leading Barb	5	3	Each
M00536260	08714729857204	Straight - No Leading Barb	5	4	Each
M00536270	08714729857211	Straight - No Leading Barb	5	5	Each
M00536280	08714729857228	Straight - No Leading Barb	5	6	Each
M00536290	08714729857235	Straight - No Leading Barb	5	7	Each
M00536300	08714729857242	Straight - No Leading Barb	5	8	Each
M00536310	08714729857259	Straight - No Leading Barb	5	9	Each
M00536320	08714729857266	Straight - No Leading Barb	5	10	Each
M00536330	08714729857273	Straight - No Leading Barb	5	11	Each
M00536340	08714729857280	Straight - No Leading Barb	5	12	Each
M00536350	08714729857297	Straight - No Leading Barb	5	13	Each

¹Product with this symbol may be used in Magnetic Resonance environment according to the conditions described in Directions for Use.

Pancreatic Plastic Stents

ADVANIX™ PANCREATIC STENTS (Continued)



 Magnetic Resonance Conditional¹

Advanix Pancreatic Stent - Straight, Leading Barb



Order Number	GTIN	Description	Diameter (Fr)	Length (cm)	Packaging
M00536360	08714729857303	Straight – Leading Barb	5	2	Each
M00536370	08714729857310	Straight – Leading Barb	5	3	Each
M00536380	08714729857327	Straight – Leading Barb	5	4	Each
M00536390	08714729857334	Straight – Leading Barb	5	5	Each
M00536400	08714729857341	Straight – Leading Barb	5	6	Each
M00536410	08714729857358	Straight – Leading Barb	5	7	Each
M00536420	08714729857365	Straight – Leading Barb	5	8	Each
M00536430	08714729857372	Straight – Leading Barb	5	9	Each
M00536440	08714729857389	Straight – Leading Barb	5	10	Each
M00536450	08714729857396	Straight – Leading Barb	5	11	Each
M00536460	08714729857402	Straight – Leading Barb	5	12	Each
M00536470	08714729857419	Straight – Leading Barb	5	13	Each
M00536480	08714729857426	Straight – Leading Barb	7	3	Each
M00536490	08714729857433	Straight – Leading Barb	7	4	Each
M00536500	08714729857440	Straight – Leading Barb	7	5	Each
M00536510	08714729857457	Straight – Leading Barb	7	6	Each
M00536520	08714729857464	Straight – Leading Barb	7	7	Each
M00536530	08714729857471	Straight – Leading Barb	7	8	Each
M00536540	08714729857488	Straight – Leading Barb	7	9	Each
M00536550	08714729857495	Straight – Leading Barb	7	10	Each
M00536560	08714729857501	Straight – Leading Barb	7	11	Each
M00536570	08714729857518	Straight – Leading Barb	7	12	Each
M00536580	08714729857525	Straight – Leading Barb	7	13	Each
M00536590	08714729857532	Straight – Leading Barb	7	15	Each
M00536600	08714729857549	Straight – Leading Barb	7	18	Each
M00536610	08714729857556	Straight – Leading Barb	10	3	Each
M00536620	08714729857563	Straight – Leading Barb	10	4	Each
M00536630	08714729857570	Straight – Leading Barb	10	5	Each
M00536640	08714729857587	Straight – Leading Barb	10	6	Each
M00536650	08714729857594	Straight – Leading Barb	10	7	Each
M00536660	08714729857600	Straight – Leading Barb	10	8	Each
M00536670	08714729857617	Straight – Leading Barb	10	9	Each
M00536680	08714729857624	Straight – Leading Barb	10	10	Each
M00536690	08714729857631	Straight – Leading Barb	10	11	Each
M00536700	08714729857648	Straight – Leading Barb	10	12	Each
M00536710	08714729857655	Straight – Leading Barb	10	13	Each
M00536720	08714729857662	Straight – Leading Barb	10	15	Each
M00536730	08714729857679	Straight – Leading Barb	10	18	Each

¹Product with this symbol may be used in Magnetic Resonance environment according to the conditions described in Directions for Use.

Pancreatic Plastic Stents

ADVANIX™ PANCREATIC STENTS (Continued)



 Magnetic Resonance Conditional¹

Advanix Pancreatic Stent - Pigtail, No Leading Barb



Order Number	GTIN	Description	Diameter (Fr)	Length (cm)	Packaging
M00536740	08714729856948	Single Pigtail – No Leading Barb	3	2	Each
M00536750	08714729856955	Single Pigtail – No Leading Barb	3	3	Each
M00536760	08714729856962	Single Pigtail – No Leading Barb	3	4	Each
M00536770	08714729856979	Single Pigtail – No Leading Barb	3	5	Each
M00536780	08714729856986	Single Pigtail – No Leading Barb	3	6	Each
M00536790	08714729856993	Single Pigtail – No Leading Barb	3	7	Each
M00536800	08714729857006	Single Pigtail – No Leading Barb	3	8	Each
M00536810	08714729857013	Single Pigtail – No Leading Barb	3	9	Each
M00536820	08714729857020	Single Pigtail – No Leading Barb	3	10	Each
M00536830	08714729857037	Single Pigtail – No Leading Barb	3	11	Each
M00536840	08714729857044	Single Pigtail – No Leading Barb	3	12	Each
M00536850	08714729857051	Single Pigtail – No Leading Barb	3	13	Each
M00536860	08714729856450	Single Pigtail – No Leading Barb	4	2	Each
M00536870	08714729856467	Single Pigtail – No Leading Barb	4	3	Each
M00536880	08714729856474	Single Pigtail – No Leading Barb	4	4	Each
M00536890	08714729856481	Single Pigtail – No Leading Barb	4	5	Each
M00536900	08714729856498	Single Pigtail – No Leading Barb	4	6	Each
M00536910	08714729856504	Single Pigtail – No Leading Barb	4	7	Each
M00536920	08714729856511	Single Pigtail – No Leading Barb	4	8	Each
M00536930	08714729856528	Single Pigtail – No Leading Barb	4	9	Each
M00536940	08714729856535	Single Pigtail – No Leading Barb	4	10	Each
M00536950	08714729856542	Single Pigtail – No Leading Barb	4	11	Each
M00536960	08714729856559	Single Pigtail – No Leading Barb	4	12	Each
M00536970	08714729856566	Single Pigtail – No Leading Barb	4	13	Each
M00536980	08714729856696	Single Pigtail – No Leading Barb	5	2	Each
M00536990	08714729856702	Single Pigtail – No Leading Barb	5	3	Each
M00537000	08714729856719	Single Pigtail – No Leading Barb	5	4	Each
M00537010	08714729856726	Single Pigtail – No Leading Barb	5	5	Each
M00537020	08714729856733	Single Pigtail – No Leading Barb	5	6	Each
M00537030	08714729856740	Single Pigtail – No Leading Barb	5	7	Each
M00537040	08714729856757	Single Pigtail – No Leading Barb	5	8	Each
M00537050	08714729856764	Single Pigtail – No Leading Barb	5	9	Each
M00537060	08714729856771	Single Pigtail – No Leading Barb	5	10	Each
M00537070	08714729856788	Single Pigtail – No Leading Barb	5	11	Each
M00537080	08714729856795	Single Pigtail – No Leading Barb	5	12	Each
M00537090	08714729856801	Single Pigtail – No Leading Barb	5	13	Each

¹Product with this symbol may be used in Magnetic Resonance environment according to the conditions described in Directions for Use.

Pancreatic Plastic Stents

ADVANIX™ PANCREATIC STENTS (Continued)



 Magnetic Resonance Conditional¹

Advanix Pancreatic Stent - Pigtail, Leading Barb



Order Number	GTIN	Description	Diameter (Fr)	Length (cm)	Packaging
M00537100	08714729856573	Single Pigtail – Leading Barb	5	2	Each
M00537110	08714729856580	Single Pigtail – Leading Barb	5	3	Each
M00537120	08714729856597	Single Pigtail – Leading Barb	5	4	Each
M00537130	08714729856603	Single Pigtail – Leading Barb	5	5	Each
M00537140	08714729856610	Single Pigtail – Leading Barb	5	6	Each
M00537150	08714729856627	Single Pigtail – Leading Barb	5	7	Each
M00537160	08714729856634	Single Pigtail – Leading Barb	5	8	Each
M00537170	08714729856641	Single Pigtail – Leading Barb	5	9	Each
M00537180	08714729856658	Single Pigtail – Leading Barb	5	10	Each
M00537190	08714729856665	Single Pigtail – Leading Barb	5	11	Each
M00537200	08714729856672	Single Pigtail – Leading Barb	5	12	Each
M00537210	08714729856689	Single Pigtail – Leading Barb	5	13	Each
M00537220	08714729856818	Single Pigtail – Leading Barb	7	3	Each
M00537230	08714729856825	Single Pigtail – Leading Barb	7	4	Each
M00537240	08714729856832	Single Pigtail – Leading Barb	7	5	Each
M00537250	08714729856849	Single Pigtail – Leading Barb	7	6	Each
M00537260	08714729856856	Single Pigtail – Leading Barb	7	7	Each
M00537270	08714729856863	Single Pigtail – Leading Barb	7	8	Each
M00537280	08714729856870	Single Pigtail – Leading Barb	7	9	Each
M00537290	08714729856887	Single Pigtail – Leading Barb	7	10	Each
M00537300	08714729856894	Single Pigtail – Leading Barb	7	11	Each
M00537310	08714729856900	Single Pigtail – Leading Barb	7	12	Each
M00537320	08714729856917	Single Pigtail – Leading Barb	7	13	Each
M00537330	08714729856924	Single Pigtail – Leading Barb	7	15	Each
M00537340	08714729856931	Single Pigtail – Leading Barb	7	18	Each

¹Product with this symbol may be used in Magnetic Resonance environment according to the conditions described in Directions for Use.

► Pancreatic Plastic Stents

NAVIFLEX™ RX PANCREATIC DELIVERY SYSTEM & NAVIFLEX PUSHERS



NaviFlex RX Pancreatic Delivery System & NaviFlex Pushers



Order Number	GTIN	Description	Diameter (Fr)	Length	Packaging
M00535060	08714729856221	NaviFlex RX Pancreatic Stent Delivery System	7	N/A	Each
M00535080	08714729856238	NaviFlex RX Pancreatic Stent Delivery System	10	N/A	Each
M00535000	08714729856207	Pancreatic Stent RX Pusher	3	N/A	Each
M00535010	08714729856214	Pancreatic Stent RX Pusher	4 / 5	N/A	Each
M00535020	08714729856184	Pancreatic Stent Pusher	3	N/A	Each
M00535030	08714729856191	Pancreatic Stent Pusher	4 / 5	N/A	Each

► Biliary Stone Management

RX STONE MANAGEMENT

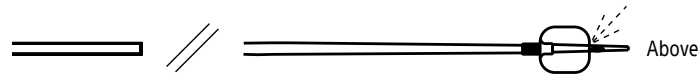

Extractor™ Pro RX-S Retrieval Balloon Catheter – Distal Injection



Order Number	GTIN	Description	Balloon Inflated O.D. (mm)	Working Length (cm)	Catheter O.D. (Fr)	Recommended Guidewire (in)	Packaging
M00547300	08714729907138	Extractor Pro RX-S Retrieval Balloon	9.0 – 12.0	200	7 - 6	.035	Each
M00547310	08714729907152	Extractor Pro RX-S Retrieval Balloon	12.0 – 15.0	200	7 - 6	.035	Each
M00547320	08714729907176	Extractor Pro RX-S Retrieval Balloon	15.0 – 18.0	200	7 - 6	.035	Each

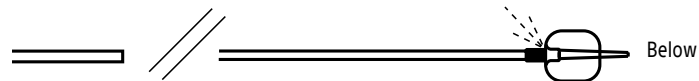

Extractor Pro RX-S Retrieval Balloon Catheter – Proximal Injection



Order Number	GTIN	Description	Balloon Inflated O.D. (mm)	Working Length (cm)	Catheter O.D. (Fr)	Recommended Guidewire (in)	Packaging
M00547330	08714729907145	Extractor Pro RX-S Retrieval Balloon	9.0 – 12.0	200	7 - 6	.035	Each
M00547340	08714729907169	Extractor Pro RX-S Retrieval Balloon	12.0 – 15.0	200	7 - 6	.035	Each
M00547350	08714729907183	Extractor Pro RX-S Retrieval Balloon	15.0 – 18.0	200	7 - 6	.035	Each

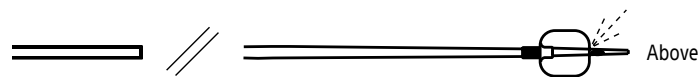

Extractor Pro RX Retrieval Balloon Catheter – Distal Injection



Order Number	GTIN	Description	Balloon Inflated O.D. (mm)	Working Length (cm)	Catheter O.D. (Fr)	Recommended Guidewire (in)	Packaging
M00547000	08714729790266	Extractor Pro RX Retrieval Balloon	9.0 – 12.0	200	7 - 6	.035	Each
M00547010	08714729790297	Extractor Pro RX Retrieval Balloon	12.0 – 15.0	200	7 - 6	.035	Each
M00547020	08714729790310	Extractor Pro RX Retrieval Balloon	15.0 – 18.0	200	7 - 6	.035	Each

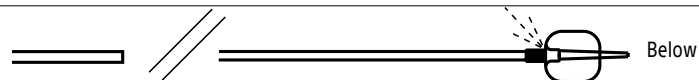

Extractor Pro RX Retrieval Balloon Catheter – Proximal Injection



Order Number	GTIN	Description	Balloon Inflated O.D. (mm)	Working Length (cm)	Catheter O.D. (Fr)	Recommended Guidewire (in)	Packaging
M00547030	08714729790280	Extractor Pro RX Retrieval Balloon	9.0 – 12.0	200	7 - 6	.035	Each
M00547040	08714729790273	Extractor Pro RX Retrieval Balloon	12.0 – 15.0	200	7 - 6	.035	Each
M00547050	08714729790303	Extractor Pro RX Retrieval Balloon	15.0 – 18.0	200	7 - 6	.035	Each

Biliary Stone Management

STONE MANAGEMENT

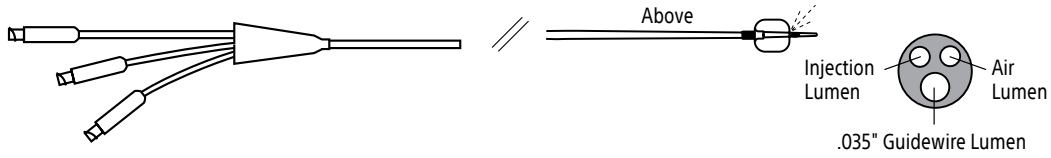

Extractor™ Pro XL Retrieval Balloon Catheter – Distal Injection



Order Number	GTIN	Description	Balloon Inflated O.D. (mm)	Working Length (cm)	Catheter O.D. (Fr)	Recommended Guidewire (in)	Packaging
M00547100	08714729790389	Extractor Pro XL Retrieval Balloon	9.0 – 12.0	200	7 - 6	.035	Each
M00547110	08714729790402	Extractor Pro XL Retrieval Balloon	12.0 – 15.0	200	7 - 6	.035	Each
M00547120	08714729790648	Extractor Pro XL Retrieval Balloon	15.0 – 18.0	200	7 - 6	.035	Each

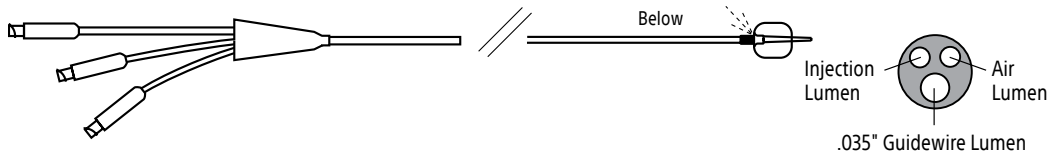

Extractor Pro XL Retrieval Balloon Catheter – Proximal Injection



Order Number	GTIN	Description	Balloon Inflated O.D. (mm)	Working Length (cm)	Catheter O.D. (Fr)	Recommended Guidewire (in)	Packaging
M00547130	08714729790396	Extractor Pro XL Retrieval Balloon	9.0 – 12.0	200	7 - 6	.035	Each
M00547140	08714729790365	Extractor Pro XL Retrieval Balloon	12.0 – 15.0	200	7 - 6	.035	Each
M00547150	08714729790372	Extractor Pro XL Retrieval Balloon	15.0 – 18.0	200	7 - 6	.035	Each

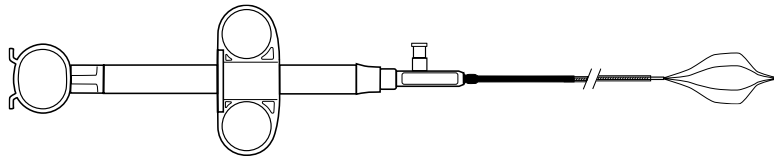

Trapezoid™ RX Wireguided Retrieval Baskets



Order Number	GTIN	Description	Open Basket Diameter (cm)	Recommended Guidewire (in)	Required Working Channel (mm)	Packaging
M00510860	08714729296379	Trapezoid RX Wireguided Retrieval Basket	1.5	.035	3.2	Each
M00510870	08714729296386	Trapezoid RX Wireguided Retrieval Basket	2.0	.035	3.2	Each
M00510880	08714729296393	Trapezoid RX Wireguided Retrieval Basket	2.5	.035	3.2	Each
M00510890*	08714729296409	Trapezoid RX Wireguided Retrieval Basket	3.0	.035	3.2	Each

Recommend Alliance™ II Inflation System for use as Mechanical Lithotriptor; Order #5062, (See page 94).

*Refer to Instructions for Use when using this device; recommended for use with Biliary Calculi of >1.5cm.

Biliary Stone Management

CRE™ WIREGUIDED BALLOON DILATATION CATHETERS

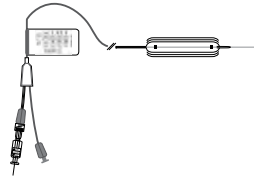

CRE PRO Wireguided Balloon Dilatation Catheters

Order Number	GTIN	Balloon Inflated O.D.		Balloon Length (cm)	Inflation Pressures		Minimum Working Channel (mm)	Catheter Size (Fr)	Working Length (cm)	Packaging
		(mm)	(Fr)		(atm)	(kPa)				
M00558600	08714729797487	6-7-8	18-21-24	5.5	3-6-10	304-608-1013	2.8 / 3.2*	7.5	180	Each
M00558610	08714729797494	8-9-10	24-27-30	5.5	3-5.5-9	304-557-912	2.8 / 3.2*	7.5	180	Each
M00558620	08714729797500	10-11-12	30-33-36	5.5	3-5-8	304-507-811	2.8 / 3.2*	7.5	180	Each
M00558630	08714729797517	12-13.5-15	36-40.5-45	5.5	3-4.5-8	304-456-811	2.8 / 3.2*	7.5	180	Each
M00558640	08714729797524	15-16.5-18	45-49.5-54	5.5	3-4.5-7	304-456-709	2.8/3.7*	7.5	180	Each
M00558650	08714729797531	18-19-20	54-57-60	5.5	3-4.5-6	304-456-608	2.8/3.7*	7.5	180	Each
M00558660	08714729797548	6-7-8	18-21-24	5.5	3-6-10	304-608-1013	2.8 / 3.2*	7.5	240	Each
M00558670	08714729797555	8-9-10	24-27-30	5.5	3-5.5-9	304-557-912	2.8 / 3.2*	7.5	240	Each
M00558680	08714729797562	10-11-12	30-33-36	5.5	3-5-8	304-507-811	2.8 / 3.2*	7.5	240	Each
M00558690	08714729797579	12-13.5-15	36-40.5-45	5.5	3-4.5-8	304-456-811	2.8 / 3.2*	7.5	240	Each
M00558700	08714729797586	15-16.5-18	45-49.5-54	5.5	3-4.5-7	304-456-709	2.8 / 3.7*	7.5	240	Each
M00558710	08714729797593	18-19-20	54-57-60	5.5	3-4.5-6	304-456-608	2.8 / 3.7*	7.5	240	Each

Recommended Inflation Device: Alliance™ II Integrated Inflation / Lithotripsy Device Order #5062, Alliance II Single-Use Syringe / Gauge Assembly Order #5060, (See page 94). Guidewire included and preloaded in balloon dilatation catheter.

*Duodenoscope channel size.

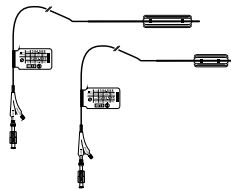

CRE RX Biliary Balloon Dilatation Catheters*

Order Number	GTIN	Balloon Inflated O.D.		Balloon Length (cm)	Inflation Pressures		Minimum Working Channel (mm)	Catheter Size (Fr)	Working Length (cm)	Packaging
		(mm)	(Fr)		(atm)	(kPa)				
M00558860	08714729965411	6-7-8	18-21-24	5.5	3-6-10	304-608-1013	3.7	7.5	180	Each
M00558870	08714729965428	8-9-10	24-27-30	5.5	3-5.5-9	304-557-912	3.7	7.5	180	Each
M00558880	08714729965435	10-11-12	30-33-36	5.5	3-5-8	304-507-811	3.7	7.5	180	Each
M00558890	08714729965442	12-13.5-15	36-40.5-45	5.5	3-4.5-8	304-456-811	3.7	7.5	180	Each
M00558900	08714729965459	15-16.5-18	45-49.5-54	5.5	3-4.5-7	304-456-709	3.7	7.5	180	Each
M00558910	08714729965466	18-19-20	54-57-60	5.5	3-4.5-6	304-456-608	3.7	7.5	180	Each
M00558920	08714729965473	8-9-10	24-27-30	3.0	3-5.5-9	304-608-1013	3.7	7.5	180	Each
M00558930	08714729965480	10-11-12	30-33-36	3.0	3-5-8	304-557-912	3.7	7.5	180	Each
M00558940	08714729965497	12-13.5-15	36-40.5-45	3.0	3-4.5-8	304-507-811	3.7	7.5	180	Each

Recommended Inflation Device: Alliance™ II Integrated Inflation / Lithotripsy Device Order #5062, Alliance II Single-Use Syringe / Gauge Assembly Order #5060.

*No Pre-loaded Guidewire in the Balloon Dilatation Catheter.

► Biliary Stricture Management

PANCREATICOBILIARY ABLATION

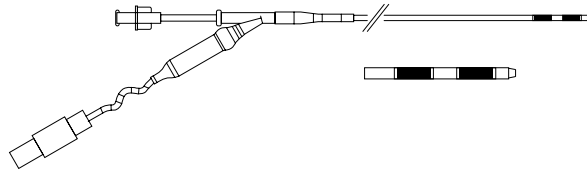

Habib™ EndoHPB Bipolar Radiofrequency Catheter

Order Number	GTIN	Description	Diameter (Fr)	Working Length (cm)	Packaging
M00500070	08714729981909	⊗ Habib EndoHPB Bipolar RF Catheter	8	180	Each

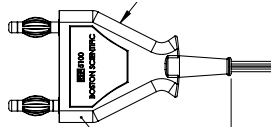

Order Number	GTIN	Description	Diameter (Fr)	Working Length (cm)	Packaging
5100	08714729982524	Bipolar Adapter Cable, 28mm spacing	NA	200	Each

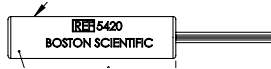

Order Number	GTIN	Description	Diameter (Fr)	Working Length (cm)	Packaging
5420	08714729982548	Bipolar Adapter Cable, Internal 4mm pin	NA	200	Each

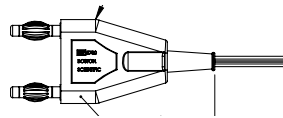

Order Number	GTIN	Description	Diameter (Fr)	Working Length (cm)	Packaging
5700	08714729982562	Bipolar Adapter Cable, 22mm spacing	NA	200	Each

RX DILATATION

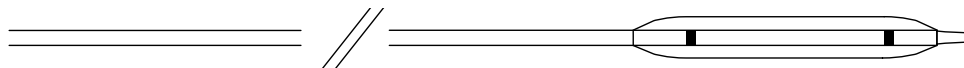

Hurricane™ RX Biliary Balloon Dilatation Catheter

Order Number	GTIN	Balloon Inflated O.D. (mm)	Balloon Length (cm)	Catheter O.D. (Fr)	Catheter Length (cm)	Maximum Inflation Pressure (atm)	Minimum Channel Size (mm)	Recommended Guidewire (in)	Packaging
M00545890	08714729283805	4	2	5.8	180	12	3.2	.035	Each
M00545900	08714729283812	4	4	5.8	180	12	3.2	.035	Each
M00545910	08714729283829	6	2	5.8	180	11	3.2	.035	Each
M00545920	08714729283836	6	4	5.8	180	11	3.2	.035	Each
M00545930	08714729283843	8	2	5.8	180	11	3.2	.035	Each
M00545940	08714729283850	8	4	5.8	180	11	3.2	.035	Each
M00545950	08714729283867	10	2	5.8	180	8	3.2	.035	Each
M00545960	08714729283874	10	4	5.8	180	8	3.2	.035	Each

Recommended inflation device: Encore™ 26 Inflation Device Order #6667, (See page 33).

► Biliary Stricture Management

RX CYTOLOGY

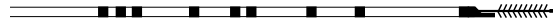

RX Cytology Brush Wireguided Cytology Brush



Order Number	GTIN	Description	Brush Width (mm)	Catheter O.D. (Fr)	Working Length (cm)	Recommended Guidewire (in)	Packaging
M00545000	08714729268628	RX Cytology Brush	2.1	8	200	.035	Each

RX ACCESSORIES

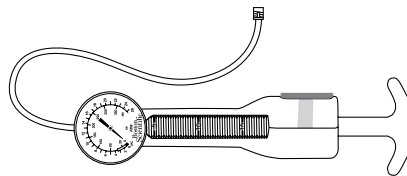

Encore™ 26 Inflation Device

Order Number	GTIN	Description	Packaging
M00566670	08714729755241	Encore 26 Inflation Device	Each



SpyGlass™ Discover Digital Catheter

▶ SpyGlass Discover Digital Catheter33	▶ Accessories33
--	-----------------------

SpyGlass™ DS Direct Visualization System

▶ Capital Equipment34	▶ Disposable Devices34
-----------------------------	------------------------------

Autolith™ Touch Biliary EHL System

▶ Autolith Touch System35	▶ Biliary EHL Probe35
▶ Autolith Touch System Accessories.....35	

EXALT™ Model D Single-Use Duodenoscope

▶ Capital Equipment36	▶ Disposable Devices36
-----------------------------	------------------------------

ExpertCare

▶ Autolith EHL Service Agreement.....37	▶ SpyGlass DS Service Agreement38
▶ Scivita Model B Service Agreement37	▶ SpyGlass Discover Service Agreement.....38
▶ EXALT Model D Service Agreement37	▶ EXALT Model D & SpyGlass DS Combination Service Agreement39

► SpyGlass™ Discover Digital Catheter & Accessories

SPYGLASS DISCOVER DIGITAL CATHETER & ACCESSORIES

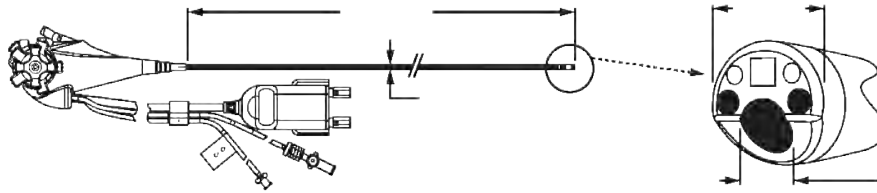

Includes
(1) Y-Adaptor



Type BF Applied Part

SpyGlass Discover Digital Catheter & Accessories



Order Number	GTIN	Description	Packaging
M00546780	8714729994183	SpyGlass™ Discover Digital Catheter	Box 1
M00542950	8714729998723	SpyGlass™ Discover Controller	Box 1
M00543000	00191506013516	SpyGlass™ Discover Balloon Dilation Catheter (6.0x40mmx40cm)	Box 1
M00543010	00191506013509	SpyGlass™ Discover Balloon Dilation Catheter (7.0x40mmx40cm)	Box 1
M00543040	00191506013493	SpyGlass™ Discover Balloon Dilation Catheter (8.0x40mmx40cm)	Box 1
M00566670	08714729755241	Encore™ 26 Inflation Device	Each
M00542961	14543527251959	Super Sheath CBDE for use with the SpyGlass	Box 10
M00542990	191506004255	SpyGlass™ Discover Retrieval Basket Box	Box 1
M00542981	191506005238	SpyGlass™ Discover Imager™ II IOC Catheter	Box 5
M00542971	191506004774	SpyGlass™ Discover Jagwire™ Guidewire	Box 2



Section Table of Contents



Prev Page

33

Next Page



Home



▶ SpyGlass™ DS Direct Visualization System

CAPITAL EQUIPMENT & DEVICES

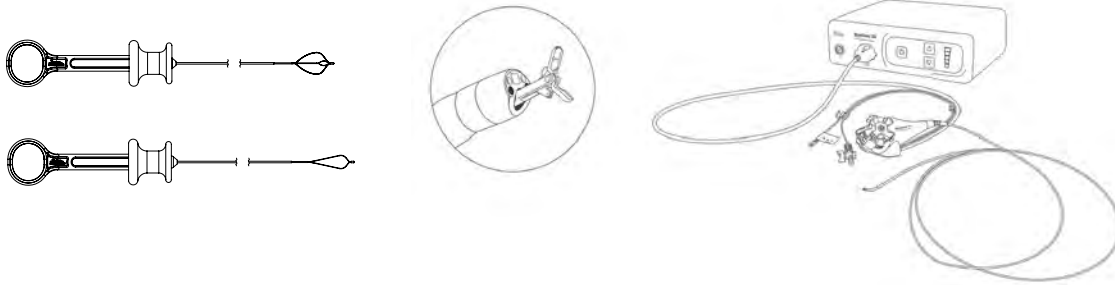

Capital Equipment

Order Number	GTIN	Description	Packaging
M00546650	08714729874348	SpyGlass DS Digital Controller	Please contact your Boston Scientific Sales Representative for ordering information.

For more information on ordering a compatible EHL or Laser Probe for the SpyGlass DS Direct Visualization System, please contact your Boston Scientific Representative.

Disposable Devices



Order Number	GTIN	Description	Packaging
M00546610	08714729965404	SpyScope™ DS II Access & Delivery Catheter	Each
M00546470	08714729996699	SpyBite™ Max Biopsy Forceps	Each
M00546550	08714729965886	SpyGlass Retrieval Basket	Each
M00546560	08714729965893	SpyGlass Retrieval Snare	Each

▶ Autolith Touch Biliary EHL System

CAPITAL EQUIPMENT & DEVICES

Autolith Touch System

M005466800	Autolith Touch Bipolar Electrohydraulic Lithotripter	Each
------------	--	------

Autolith Touch System Accessories

M00546750	Autolith Touch Extender Cable	Each
-----------	-------------------------------	------

M00546760	Autolith Touch Foot Switch	Each
-----------	----------------------------	------

Biliary EHL Probe

Order Number	Description	Packaging
M00546620	 1.9, 375cm Biliary Electrohydraulic Lithotripter Probe	Each

▶ EXALT™ Model D Single-Use Duodenoscope

CAPITAL EQUIPMENT & DEVICES

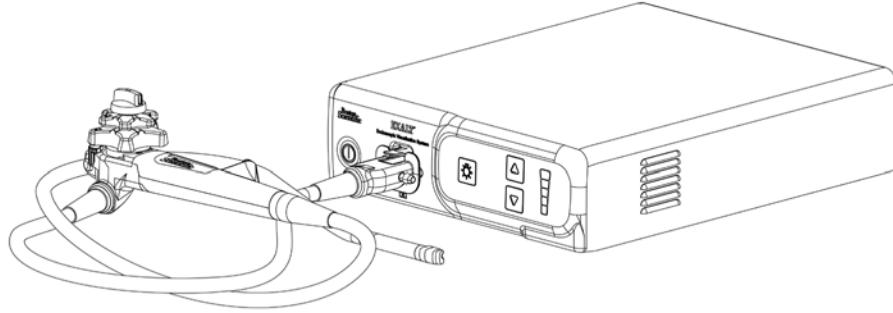

Capital Equipment

Order Number	GTIN	Description	Packaging
M00542430	08714729990901	EXALT™ Controller	Please contact your Boston Scientific Sales Representative for ordering information.

Disposable Devices

Order Number	GTIN	Description	Packaging
M00542420	08714729983514	EXALT™ Model D Single-use Duodenoscope	Each
M00542421	08714729993605	EXALT™ Model D Single-use Duodenoscope	Box 2
M00542423	N/A - 2x 08714729993605	EXALT™ Model D Single-use Duodenoscope	Box 4
M00542424	N/A - 4x 08714729993605	EXALT™ Model D Single-use Duodenoscope	Box 8

SERVICE AGREEMENT

Autolith EHL

Service Agreement	Who Owns Title	ZSER	Description
EverCare	BSC or Customer	SRVM005AUTOLITHEC1	Autolith EHL EverCare 3 year POS
EverCare	BSC or Customer	SRVM005AUTOLITHEC2	Autolith EHL EverCare 3 year POST
TotalCare	Customer	SRVM005ATLTOTLCR01	Autolith EHL TotalCare Customer 1 year POS
TotalCare	Customer	SRVM005ATLTOTLCR05	Autolith EHL TotalCare Customer 1 year POST
TotalCare	Customer	SRVM005ATLTOTLCR02	Autolith EHL TotalCare Customer 2 year POS
TotalCare	Customer	SRVM005ATLTOTLCR06	Autolith EHL TotalCare Customer 2 year POST
TotalCare	Customer	SRVM005ATLTOTLCR03	Autolith EHL TotalCare Customer 3 year POS
TotalCare	Customer	SRVM005ATLTOTLCR07	Autolith EHL TotalCare Customer 3 year POST
TotalCare	Customer	SRVM005ATLTOTLCR04	Autolith EHL TotalCare Customer 4 year POS
TotalCare	Customer	SRVM005ATLTOTLCR08	Autolith EHL TotalCare Customer 4 year POST
TotalCare	BSC	SRVM005AUTOTCPVA01	Autolith EHL TotalCare BSC 1 year POS
TotalCare	BSC	SRVM005AUTOTCPVA05	Autolith EHL TotalCare BSC 1 year POST

Scivita Model B

Service Agreement	Who Owns Title	ZSER	Description
TotalCare	BSC	SRVM005HDVS300TC10	Scivita Model B TotalCare BSC 2 year POS
TotalCare	BSC	SRVM005HDVS300TC14	Scivita Model B TotalCare BSC 2 year POST
TotalCare	Customer	SRVM005HDVS300TC02	Scivita Model B TotalCare Customer 2 year POS
TotalCare	Customer	SRVM005HDVS300TC06	Scivita Model B TotalCare Customer 2 year POST
Essential Care	Customer	SRVM005HDVSS300EC2	Scivita Model B EssentialCare Customer 2 year POS
Essential Care	Customer	SRVM005HDVSS300EC6	Scivita Model B EssentialCare Customer 2 year POST

EXALT Model D

Service Agreement	Who Owns Title	ZSER	Description
EverCare	Customer	SRVM005EXLTDEVCO1	EXALT Model D EverCare Customer 3 year POS
EverCare	Customer	SRVM005EXLTDEVCO2	EXALT Model D EverCare Customer 3 year POST
EverCare	BSC	SRVM005EXTDBSEVCO1	EXALT Model D EverCare BSC 3 year POS
EverCare	BSC	SRVM005EXTDBSEVCO2	EXALT Model D EverCare BSC 3 year POST
TotalCare	Customer	SRVM005EXALTDTC01	EXALT Model D TotalCare Customer 1 year POS
TotalCare	Customer	SRVM005EXALTDTC06	EXALT Model D TotalCare Customer 1 year POST
TotalCare	Customer	SRVM005EXALTDTC02	EXALT Model D TotalCare Customer 2 year POS
TotalCare	Customer	SRVM005EXALTDTC07	EXALT Model D TotalCare Customer 2 year POST
TotalCare	BSC	SRVM005EXADTCPVA01	EXALT Model D TotalCare BSC 1 year POS
TotalCare	BSC	SRVM005EXADTCPVA05	EXALT Model D TotalCare BSC 1 year POST
EssentialCare	Customer	SRVM005EXALTDEC01	EXALT Model D EssentialCare Customer 1 year POS
EssentialCare	Customer	SRVM005EXALTDEC05	EXALT Model D EssentialCare Customer 1 year POST
EssentialCare	Customer	SRVM005EXALTDEC02	EXALT Model D EssentialCare Customer 2 year POS
EssentialCare	Customer	SRVM005EXALTDEC06	EXALT Model D EssentialCare Customer 2 year POST

SERVICE AGREEMENT

SpyGlass DS			
Service Agreement	Who Owns Title	ZSER	Description
EverCare	Customer	SRVM005SPYDSEVCS01	SpyGlass DS EverCare Customer 3 year POS
EverCare	Customer	SRVM005SPYDSEVCS02	SpyGlass DS EverCare Customer 3 year POST
EverCare	BSC	SRVM005SPYDSBSC01	SpyGlass DS EverCare BSC 3 year POS
EverCare	BSC	SRVM005SPYDSBSC02	SpyGlass DS EverCare BSC 3 year POS
TotalCare	Customer	SRVM005SPYDIGTCR01	SpyGlass DS TotalCare Customer 1 year POS
TotalCare	Customer	SRVM005SPYDIGTCR05	SpyGlass DS TotalCare Customer 1 year POST
TotalCare	Customer	SRVM005SPYDIGTCR02	SpyGlass DS TotalCare Customer 2 year POS
TotalCare	Customer	SRVM005SPYDIGTCR06	SpyGlass DS TotalCare Customer 2 year POST
TotalCare	Customer	SRVM005SPYDIGTCR03	SpyGlass DS TotalCare Customer 3 year POS
TotalCare	Customer	SRVM005SPYDIGTCR07	SpyGlass DS TotalCare Customer 3 year POST
TotalCare	BSC	SRVM005SPYDSTCPVA1	SpyGlass DS TotalCare BSC 1 year POS
TotalCare	BSC	SRVM005SPYDSTCPVA5	SpyGlass DS TotalCare BSC 1 year POST
EssentialCare	Customer	SRVM005SPYDIG1001	SpyGlass DS EssentialCare Customer 1 year POS
EssentialCare	Customer	SRVM005SPYDIG100	SpyGlass DS EssentialCare Customer 1 year POST
EssentialCare	Customer	SRVM005SPYDIG1002	SpyGlass DS EssentialCare Customer 2 year POS
EssentialCare	Customer	SRVM005SPYDIG1006	SpyGlass DS EssentialCare Customer 2 year POST
EssentialCare	Customer	SRVM005SPYDIG1003	SpyGlass DS EssentialCare Customer 3 year POS
EssentialCare	Customer	SRVM005SPYDIG1007	SpyGlass DS EssentialCare Customer 3 year POST

SpyGlass Discover			
Service Agreement	Who Owns Title	ZSER	Description
TotalCare	BSC	SRVM005SPYDISPVA01	SpyGlass Discover TotalCare BSC 1 year POS
TotalCare	BSC	SRVM005SPYDISPVA05	SpyGlass Discover TotalCare BSC 1 year POST
TotalCare	Customer	SRVM005SPYDISTC01	SpyGlass Discover TotalCare Customer 1 year POS
TotalCare	Customer	SRVM005SPYDISTC05	SpyGlass Discover TotalCare Customer 1 year POST
TotalCare	Customer	SRVM005SPYDISTC02	SpyGlass Discover TotalCare Customer 2 year POS
TotalCare	Customer	SRVM005SPYDISTC06	SpyGlass Discover TotalCare Customer 2 year POST
TotalCare	Customer	SRVM005SPYDISTC03	SpyGlass Discover TotalCare Customer 3 year POS
TotalCare	Customer	SRVM005SPYDISTC07	SpyGlass Discover TotalCare Customer 3 year POST
TotalCare	Customer	SRVM005SPYDISTC04	SpyGlass Discover TotalCare Customer 4 year POS
TotalCare	Customer	SRVM005SPYDISTC08	SpyGlass Discover TotalCare Customer 4 year POST
EssentialCare	Customer	SRVM005SPYDISEC01	SpyGlass Discover EssentialCare Customer 1 year POS
EssentialCare	Customer	SRVM005SPYDISEC05	SpyGlass Discover EssentialCare Customer 1 year POST
EssentialCare	Customer	SRVM005SPYDISEC02	SpyGlass Discover EssentialCare Customer 2 year POS
EssentialCare	Customer	SRVM005SPYDISEC06	SpyGlass Discover EssentialCare Customer 2 year POST
EssentialCare	Customer	SRVM005SPYDISEC03	SpyGlass Discover EssentialCare Customer 3 year POS
EssentialCare	Customer	SRVM005SPYDISEC07	SpyGlass Discover EssentialCare Customer 3 year POST
EssentialCare	Customer	SRVM005SPYDISEC04	SpyGlass Discover EssentialCare Customer 4 year POS
EssentialCare	Customer	SRVM005SPYDISEC08	SpyGlass Discover EssentialCare Customer 4 year POST

SERVICE AGREEMENT

Spy DS + Exalt D Combo			
Service Agreement	Who Owns Title	ZSER	Description
EverCare	Customer	SRVM005EXTSPYEVC01	EXALT D and Spy DS ComboEverCare Customer 3 year POS
EverCare	Customer	SRVM005EXTSPYEVC02	EXALT D and Spy DS Combo EverCare Customer 3 year POST

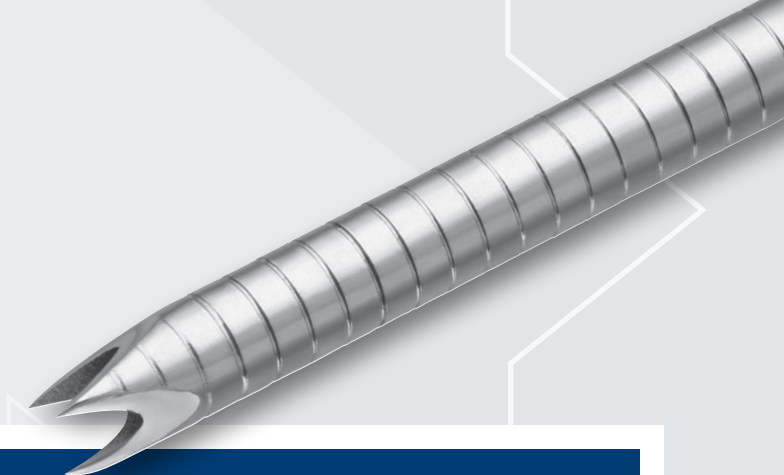

EUS

**Expect™ Slimline (SL) Endoscopic
Ultrasound Aspiration Needles**

- Expect Slimline (SL) Endoscopic Ultrasound
Aspiration Needle40

**Acquire™ Endoscopic Ultrasound
Fine Needle Biopsy (FNB) Device**

- Acquire Endoscopic Ultrasound Fine Needle
Biopsy (FNB) Device40
- Acquire S Endoscopic Ultrasound Fine Needle
Biopsy (FNB) Device40

LumiCoil™ Platinum Fiducial Markers

- LumiCoil Platinum Fiducial Markers –
Straight Configuration..... 41
- LumiCoil Platinum Fiducial Markers –
Figure 8 Configuration 41

AXIOS™ System

- AXIOS Stent and Electrocautery Enhanced Delivery System 41
- AXIOS Stent and Delivery System 41

EXPECT™ SLIMLINE (SL) ENDOSCOPIC ULTRASOUND ASPIRATION NEEDLES

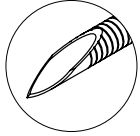

Expect Slimline (SL) Endoscopic Ultrasound Aspiration Needle*



Order Number	GTIN	Needle Size	Minimum Working Channel (mm)	Sheath Diameter (mm)	Packaging
M00555500	08714729848141	19 gauge (1.10mm)	2.8	1.83	Each
M00555510	08714729848158	22 gauge (0.72mm)	2.4	1.65	Each
M00555520	08714729848165	25 gauge (0.52mm)	2.4	1.52	Each
M00555530	08714729848172	19 gauge Flex (1.14mm)	2.8	1.73	Each
M00555501	08714729848714	19 gauge (1.10mm)	2.8	1.83	Box 5
M00555511	08714729848721	22 gauge (0.72mm)	2.4	1.65	Box 5
M00555521	08714729848738	25 gauge (0.52mm)	2.4	1.52	Box 5
M00555531	08714729848806	19 gauge Flex (1.14mm)	2.8	1.73	Box 5

*Packaging also includes: 20cc syringe and one-way stopcock

*Needle length: 0cm to 8cm, adjustable

*Working length: 137.5cm to 141.5cm, adjustable

ACQUIRE™ ENDOSCOPIC ULTRASOUND FINE NEEDLE BIOPSY (FNB) DEVICE



Acquire Endoscopic Ultrasound Fine Needle Biopsy (FNB) Device*



Order Number	GTIN	Needle Size	Minimum Working Channel (mm)	Sheath Diameter (mm)	Packaging
M00555540	08714729931782	22 gauge (0.72mm)	2.4	1.65	Each
M00555560	08714729931805	25 gauge (0.52mm)	2.4	1.52	Each
M00555580	08714729931829	19 gauge Flex (1.14mm)	2.8	1.73	Each
M00555541	08714729931843	22 gauge (0.72mm)	2.4	1.65	Box 5
M00555561	08714729931867	25 gauge (0.52mm)	2.4	1.52	Box 5

*Packaging also includes: 20cc syringe and one-way stopcock

*Needle length: 0cm to 8cm, adjustable

*Working length: 137.5cm to 141.5cm, adjustable



Acquire™ S Endoscopic Ultrasound Fine Needle Biopsy (FNB) Device



Order Number	GTIN	Description	Minimum Working Channel (mm)	Sheath Diameter (mm)	Packaging
M00555640	00191506030742	Acquire S 22ga	2.4	1.65	Each
M00555660	00191506030759	Acquire S 25ga	2.4	1.52	Each

LUMICOIL™ PLATINUM FIDUCIAL MARKERS



LumiCoil Platinum Fiducial Markers



Order Number	GTIN	Description	Fiducial O.D. (in)	Overall Fiducial Length (mm)	Implanted Fiducial Length (mm)	Differentiator	Packaging
M00553831	08714729972877	Lumicoil Platinum Fiducial Marker	0.018	5	5	Straight	Box 3
M00553841	08714729972891	Lumicoil Platinum Fiducial Marker	0.018	10	5	Figure 8	Box 3

AXIOS™ SYSTEM

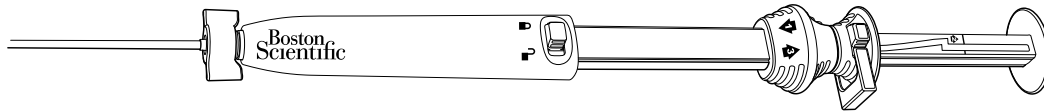

AXIOS Stent and Electrocautery Enhanced Delivery System



Order Number	GTIN	Flange Diameter (mm)	Lumen Diameter (mm)	Saddle Length (mm)	Catheter O.D. (Fr)	Catheter Working Length (cm)	Catheter Total Length (cm)	Packaging
M00553640	08714729904588	21	10	10	10.8	138	144	Each
M00553650	08714729904595	24	15	10	10.8	138	144	Each
M00553660	08714729951179	29	20	10	10.8	138	144	Each
M00553670	8714729979333	24	15	15	10.8	138	144	Each
M00553680	00191506008086	14	6	8	9	138	144	Each
M00553690	00191506008093	17	8	8	9	138	144	Each

AXIOS Stent and Delivery System



Order Number	GTIN	Flange Diameter (mm)	Lumen Diameter (mm)	Saddle Length (mm)	Catheter O.D. (Fr)	Catheter Working Length (cm)	Catheter Total Length (cm)	Packaging
M00553740	08714729904625	21	10	10	10.8	138	144	Each
M00553750	08714729904632	24	15	10	10.8	138	144	Each

► Enteral and Esophageal Stents

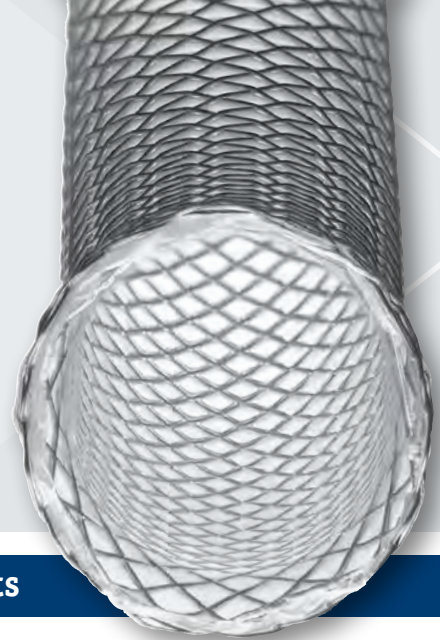

Enteral and Esophageal Stents

Colonic and Duodenal Stents

► WallFlex™ Soft Colonic Stent System	42
► WallFlex Colonic Stent System with Anchor Lock Delivery System	42
► WallFlex Soft Duodenal Stent System.....	43
► WallFlex Duodenal Stent System with Anchor Lock Delivery System	43

Esophageal Stents

► Agile Partially Covered Esophageal Stent System	44
► Agile Fully Covered Esophageal Stent System.....	44
► WallFlex Fully Covered Esophageal Stent System.....	45
► WallFlex Partially Covered Esophageal Stent System	45
► Ultraflex Esophageal NG Covered Stent System – Distal Release.....	46
► Ultraflex Esophageal NG Covered Stent System – Proximal Release.....	46
► Ultraflex Esophageal NG Covered Stent System – Distal Release.....	46
► Ultraflex Esophageal NG Covered Stent System – Proximal Release.....	47
► Ultraflex Esophageal NG Stent Uncovered System – Distal Release.....	47
► Ultraflex Esophageal NG Uncovered Stent System – Proximal Release.....	47
► Amplatz Super Stiff™ Guidewire	47

► Enteral Stents

WALLFLEX™ COLONIC AND DUODENAL STENTS

Wallflex Soft Colonic Stent System



Order Number	GTIN	Stent Body Diameter (mm)	Stent Flare Diameter (mm)	Expanded Stent Length (mm)	Working Length (cm)	Delivery System Length (cm)	Delivery System Diameter (Fr)	Packaging
M00555760	08714729902584	22	27	60	230		9	Each
M00555770	08714729902591	22	27	90	230		9	Each
M00555780	08714729902607	22	27	120	230		9	Each

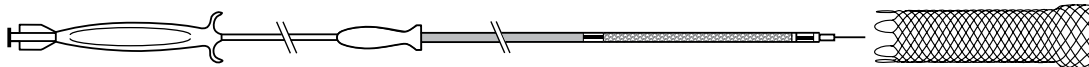

Magnetic Resonance Conditional¹

WallFlex Colonic Stent System with Anchor Lock Delivery System*



Order Number	GTIN	Stent Body Diameter (mm)	Stent Flare Diameter (mm)	Expanded Stent Length (mm)	Working Length (cm)	Delivery System Length (cm)	Delivery System Diameter (Fr)	Packaging
M00565040	08714729456513	25	30	60	230	270	10	Each
M00565050	08714729456520	25	30	90	230	270	10	Each
M00565060	08714729456537	25	30	120	230	270	10	Each
M00565070	08714729456544	25	30	60	135	175	10	Each
M00565080	08714729456551	25	30	90	135	175	10	Each
M00565090	08714729456568	25	30	120	135	175	10	Each
M00565100	08714729456575	22	27	60	230	270	10	Each
M00565110	08714729456582	22	27	90	230	270	10	Each
M00565120	08714729456599	22	27	120	230	270	10	Each
M00565130	08714729456605	22	27	60	135	175	10	Each
M00565140	08714729456612	22	27	90	135	175	10	Each
M00565150	08714729456629	22	27	120	135	175	10	Each

*Recommended Guidewire .035" WALLSTENT™ Super Stiff Guidewire, Order #18001, (See page 3).

¹Product with this symbol may be used in Magnetic Resonance environment according to the conditions described in Directions for Use.

► Enteral Stents

WALLFLEX™ COLONIC AND DUODENAL STENTS (Continued)

WallFlex Soft Duodenal Stent System



Order Number	GTIN	Stent Body Diameter (mm)	Flare Diameter (mm)	Expanded Stent Length (mm)	Working Length (cm)	Delivery System Length (cm)	Delivery System Diameter (Fr)	Packaging
M00555860	08714729902492	22	27	60	230		9	Each
M00555870	08714729902508	22	27	90	230		9	Each
M00555880	08714729902515	22	27	120	230		9	Each



Magnetic Resonance Conditional¹

WallFlex Duodenal Stent System with Anchor Lock Delivery System*



Order Number	GTIN	Stent Body Diameter (mm)	Flare Diameter (mm)	Expanded Stent Length (mm)	Working Length (cm)	Delivery System Length (cm)	Delivery System Diameter (Fr)	Packaging
M00565010	08714729456483	22	27	60	230	270	10	Each
M00565020	08714729456490	22	27	90	230	270	10	Each
M00565030	08714729456506	22	27	120	230	270	10	Each

*Recommended Guidewire .035" Hydra Jagwire™ Guidewire Stiff Shaft 450cm Order #5606, (See page 1).

¹Product with this symbol may be used in Magnetic Resonance environment according to the conditions described in Directions for Use.

▶ Esophageal Stents

AGILE™ ESOPHAGEAL STENTS

Agile Partially Covered Esophageal Stent System



Order Number	GTIN	Stent O.D. (mm)	Proximal / Distal Flares O.D. (mm)	Stent Length (cm)	Catheter Diameter (Fr / mm)	Packaging
M00517710	191506006587	23	28	6.2	18.5 / 6.2	Each
M00517720	191506006594	23	28	10.1	18.5 / 6.2	Each
M00517730	191506006600	23	28	12	18.5 / 6.2	Each
M00517740	191506006617	23	28	15	18.5 / 6.2	Each
M00517200	08714729972907	14	19	6.2	10.5 / 3.5	Each
M00517210	08714729972914	14	19	10.2	10.5 / 3.5	Each
M00517220	08714729972921	14	19	11.9	10.5 / 3.5	Each
M00517230	08714729972938	14	19	14.8	10.5 / 3.5	Each
M00517240	08714729972945	18	23	5.9	10.5 / 3.5	Each
M00517250	08714729972952	18	23	9.7	10.5 / 3.5	Each
M00517260	08714729972969	18	23	11.9	10.5 / 3.5	Each
M00517270	08714729972976	18	23	14.9	10.5 / 3.5	Each

Agile Fully Covered Esophageal Stent System



Order Number	GTIN	Stent O.D. (mm)	Proximal / Distal Flares O.D. (mm)	Stent Length (cm)	Catheter Diameter (Fr / mm)	Packaging
M00517750	191506006624	23	28	6.2	18.5 / 6.2	Each
M00517760	191506006631	23	28	10.1	18.5 / 6.2	Each
M00517770	191506006648	23	28	12	18.5 / 6.2	Each
M00517780	191506006655	23	28	15	18.5 / 6.2	Each
M00517400	08714729973027	14	19	6.2	10.5 / 3.5	Each
M00517410	08714729973034	14	19	10.2	10.5 / 3.5	Each
M00517420	08714729973041	14	19	11.9	10.5 / 3.5	Each
M00517430	08714729973058	14	19	14.8	10.5 / 3.5	Each
M00517440	08714729973065	18	23	5.9	10.5 / 3.5	Each
M00517450	08714729973072	18	23	9.7	10.5 / 3.5	Each
M00517460	08714729973089	18	23	11.9	10.5 / 3.5	Each
M00517470	08714729973096	18	23	14.9	10.5 / 3.5	Each

▶ Esophageal Stents

WALLFLEX™ ESOPHAGEAL STENTS

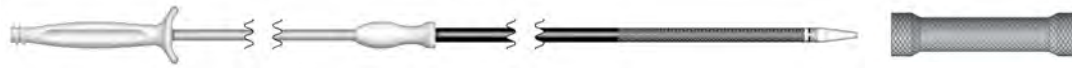

 Magnetic Resonance Conditional

WallFlex Fully Covered Esophageal Stent System*



Order Number	GTIN	Stent O.D. (mm)	Proximal / Distal Flares O.D. (mm)	Stent Length (cm)	Catheter Diameter (Fr / mm)	Working Length (cm)	Packaging
M00516700	08714729778035	18	25 / 23	10.3	18.5 / 6.2	78	Each
M00516710	08714729778042	18	25 / 23	12.3	18.5 / 6.2	78	Each
M00516720	08714729778059	18	25 / 23	15.3	18.5 / 6.2	78	Each
M00516730	08714729778066	23	28 / 28	10.5	18.5 / 6.2	78	Each
M00516740	08714729778073	23	28 / 28	12.5	18.5 / 6.2	78	Each
M00516750	08714729778080	23	28 / 28	15.5	18.5 / 6.2	78	Each

*Recommended Guidewire .038" Jagwire™ Guidewire, Order #5662,  (See page 2).

¹Product with this symbol may be used in Magnetic Resonance environment according to the conditions described in Directions for Use.

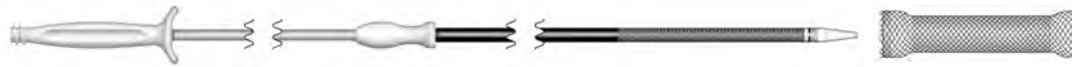

 Magnetic Resonance Conditional

WallFlex Partially Covered Esophageal Stent System*



Order Number	GTIN	Stent O.D. (mm)	Proximal / Distal Flares O.D. (mm)	Stent Length (cm)	Covered Length (cm)	Catheter Diameter (Fr / mm)	Working Length (cm)	Packaging
M00516900	08714729765240	18	23 / 23	10.3	7.1	18.5 / 6.2	78	Each
M00516910	08714729765257	18	23 / 23	12.3	9.1	18.5 / 6.2	78	Each
M00516920	08714729765264	18	23 / 23	15.3	12.1	18.5 / 6.2	78	Each
M00516930	08714729765271	23	28 / 28	10.5	7.3	18.5 / 6.2	78	Each
M00516940	08714729765288	23	28 / 28	12.5	9.3	18.5 / 6.2	78	Each
M00516950	08714729765295	23	28 / 28	15.5	12.3	18.5 / 6.2	78	Each

*Recommended Guidewire .038" Jagwire Guidewire, Order #5662,  (See page 2).

¹Product with this symbol may be used in Magnetic Resonance environment according to the conditions described in Directions for Use.

▶ Esophageal Stents

ULTRAFLEX™ STENTS

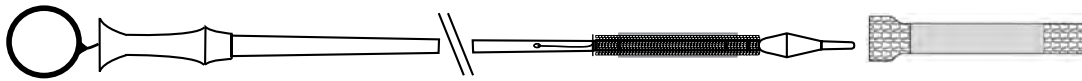

 Magnetic Resonance Conditional¹

Ultraflex Esophageal NG Covered Stent System – Distal Release*



Order Number	GTIN	Stent O.D. (mm)	Proximal Flare O.D. (mm)	Stent Length (cm)	Covered Length (cm)	Packaging
M00513730	08714729716150	18	23	10	7	Each
M00513740	08714729716167	18	23	12	9	Each
M00513750	08714729649113	18	23	15	12	Each

*Recommended Guidewire .038" Jagwire™ Guidewire, Order #5662,  (See page 2).

¹Product with this symbol may be used in Magnetic Resonance environment according to the conditions described in Directions for Use.

 Magnetic Resonance Conditional¹

Ultraflex Esophageal NG Stent Covered System – Proximal Release*



Order Number	GTIN	Stent O.D. (mm)	Proximal Flare O.D. (mm)	Stent Length (cm)	Covered Length (cm)	Packaging
M00513840	08714729716099	18	23	10	7	Each
M00513850	08714729716075	18	23	12	9	Each
M00513860	08714729716082	18	23	15	12	Each

*Recommended Guidewire .038" Jagwire Guidewire, Order #5662,  (See page 2).

¹Product with this symbol may be used in Magnetic Resonance environment according to the conditions described in Directions for Use.

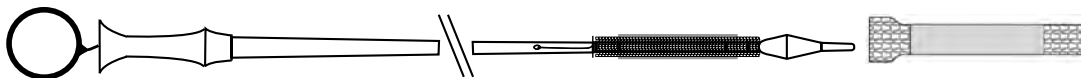

 Magnetic Resonance Conditional¹

Ultraflex Esophageal NG Stent Covered System – Distal Release*



Order Number	GTIN	Stent O.D. (mm)	Proximal Flare O.D. (mm)	Stent Length (cm)	Covered Length (cm)	Packaging
M00514200	08714729121190	23	28	10	7	Each
M00514210	08714729121206	23	28	12	9	Each

*Recommended Guidewire .038" Jagwire™ Guidewire, Order #5662,  (See page 2).

¹Product with this symbol may be used in Magnetic Resonance environment according to the conditions described in Directions for Use.

Esophageal Stents

ULTRAFLEX™ STENTS (Continued)

 Magnetic Resonance Conditional¹

Ultraflex Esophageal NG Covered Stent System – Proximal Release*



Order Number	GTIN	Stent O.D. (mm)	Proximal Flare O.D. (mm)	Stent Length (cm)	Covered Length (cm)	Packaging
M00514240	08714729716105	23	28	10	7	Each
M00514250	08714729716112	23	28	12	9	Each

*Recommended Guidewire .038" Jagwire™ Guidewire, Order #5662,  (See page 2).

¹Product with this symbol may be used in Magnetic Resonance environment according to the conditions described in Directions for Use.

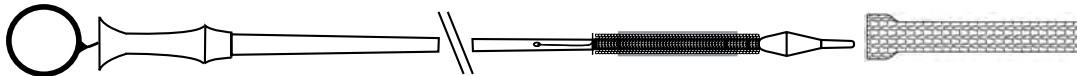

 Magnetic Resonance Conditional¹

Ultraflex Esophageal NG Uncovered Stent System – Distal Release*



Order Number	GTIN	Stent O.D. (mm)	Proximal Flare O.D. (mm)	Stent Length (cm)	Packaging
M00513700	08714729716129	18	23	7	Each
M00513710	08714729716136	18	23	10	Each
M00513720	08714729716143	18	23	15	Each

*Recommended Guidewire .038" Jagwire Guidewire, Order #5662,  (See page 2).

¹Product with this symbol may be used in Magnetic Resonance environment according to the conditions described in Directions for Use.

 Magnetic Resonance Conditional¹

Ultraflex Esophageal NG Uncovered Stent System – Proximal Release*



Order Number	GTIN	Stent O.D. (mm)	Proximal Flare O.D. (mm)	Stent Length (cm)	Packaging
M00513800	08714729716174	18	23	7	Each
M00513810	08714729716181	18	23	10	Each
M00513830	08714729716204	18	23	15	Each

*Recommended Guidewire .038" Jagwire Guidewire, Order #5662,  (See page 2).

¹Product with this symbol may be used in Magnetic Resonance environment according to the conditions described in Directions for Use.

 Magnetic Resonance Conditional¹

Amplatz Super Stiff™ Guidewire



Order Number	GTIN	Description	O.D. (in)	Length (cm)	Tip Style	Packaging
M00550090	08714729301929	Amplatz Super Stiff Guidewire	.038	260	Straight	Each



Hemostasis

Clipping Devices

- ▶ MANTIS™ Clip..... 48
- ▶ Resolution 360™ ULTRA Clip..... 48
- ▶ Resolution 360™ Clip..... 48
- ▶ Resolution™ Clip..... 49

Bipolar Electrohemostasis Catheters

- ▶ Injection Gold Probe™ Single-Use Electrohemostasis / Injection Catheters 49
- ▶ Gold Probe™ Single-Use Electrohemostasis Catheters 49

Needles

- ▶ Interject™ Clear Single-Use Injection Therapy Needle Catheters..... 50
- ▶ Interject Contrast Single-Use Injection Therapy Needle Catheters..... 50

Multiple Band Ligators

- ▶ Speedband Superview Super 7™ Multiple Band Ligators 51

Electrosurgical Bipolar Cable Adapter

- ▶ Electrosurgical Bipolar Cable Adapter..... 52

► Hemostasis

CLIPPING DEVICES

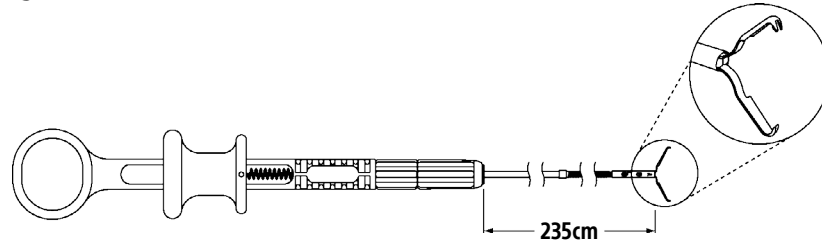

MANTIS™ Clip



Order Number	GTIN	Working Length (cm)	Minimum Working Channel (mm)	Packaging
M00521420	00191506023591	235	2.8	Each
M00521421	00191506023607	235	2.8	Box 10
M00521422	00191506023614	235	2.8	Box 20

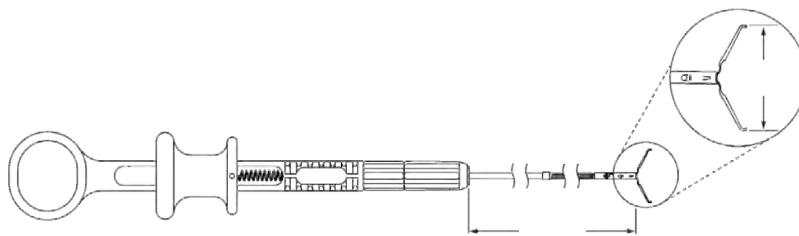

Resolution 360™ ULTRA Clip



Order Number	GTIN	Working Length (cm)	Minimum Working Channel (mm)	Clip Opening (mm)	Packaging
M00521400	08714729997245	235	2.8	17	Each
M00521401	08714729997252	235	2.8	17	Box 10
M00521402	08714729997269	235	2.8	17	Box 20
M00521403	08714729997276	235	2.8	17	Box 40



 Magnetic Resonance Conditional¹

Resolution 360™ Clip



Order Number	GTIN	Working Length (cm)	Minimum Working Channel (mm)	Clip Opening (mm)	Packaging
M00521240	08714729875666	155	2.8	11	Each
M00521241	08714729875673	155	2.8	11	Box 10
M00521242	08714729875680	155	2.8	11	Box 20
M00521230	08714729875628	235	2.8	11	Each
M00521231	08714729875635	235	2.8	11	Box 10
M00521232	08714729875642	235	2.8	11	Box 20
M00521233	08714729875659	235	2.8	11	Box 40

¹Product with this symbol may be used in Magnetic Resonance environment according to the conditions described in Directions for Use.

CLIPPING DEVICES (Continued)

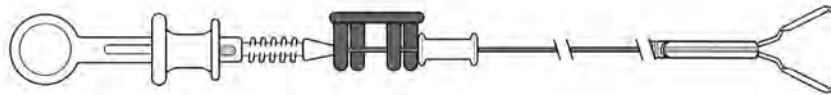



 Magnetic Resonance Conditional¹

Resolution™ Clip 					
Order Number	GTIN	Working Length (cm)	Minimum Working Channel (mm)	Clip Opening (mm)	Packaging
M00522600	08714729504764	155	2.8	11	Each
M00522601	08714729504771	155	2.8	11	Box 10
M00522602	08714729504788	155	2.8	11	Box 20
M00522610	08714729504795	235	2.8	11	Each
M00522611	08714729504801	235	2.8	11	Box 10
M00522612	08714729504818	235	2.8	11	Box 20

¹Product with this symbol may be used in Magnetic Resonance environment according to the conditions described in Directions for Use.

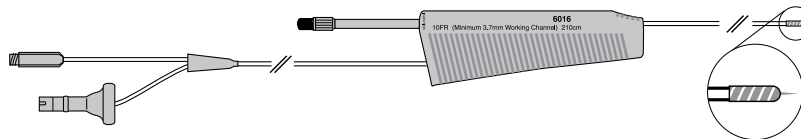
BIPOLAR ELECTROHEMOSTASIS CATHETERS



Injection Gold Probe™ Single-Use Electrohemostasis / Injection Catheters 							
Order Number	GTIN	Description	O.D. (Fr)	Needle Size Gauge	Working Length (cm)	Type Generator / Connector	Packaging
M00560150	08714729056492	Injection Gold Probe Catheter	7	25	210	Standard Plug*	Each
M00560160	08714729056508	Injection Gold Probe Catheter	10	25	210	Standard Plug*	Each

*Compatible with Endostat™ Bipolar-Monopolar Electrosurgical Generators.

For connections to other generators, please refer to the Electrosurgical Bipolar Cable Adapters,  (See page 52).

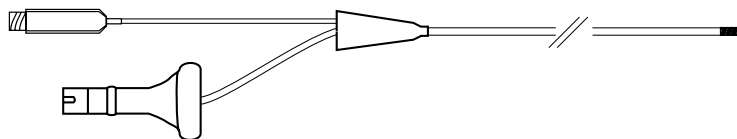

Gold Probe™ Single-Use Electrohemostasis Catheters 							
Order Number	GTIN	Description	O.D. (Fr)	Working Length (cm)	Type Generator / Connector	Packaging	
M00560070	08714729174691	Gold Probe Catheter	7	300	Standard Plug*	Each	
M00560100	08714729174684	Gold Probe Catheter	10	300	Standard Plug*	Each	
M00560220	08714729099574	Gold Probe Catheter	7	350	Standard Plug*	Each	
M00560071	08714729071013	Gold Probe Catheter	7	300	Standard Plug*	Box 5	
M00560101	08714729071020	Gold Probe Catheter	10	300	Standard Plug*	Box 5	

*Compatible with Endostat Bipolar-Monopolar Electrosurgical Generators.

For connections to other generators, please refer to the Electrosurgical Bipolar Cable Adapters,  (See page 52).

► Hemostasis

NEEDLES

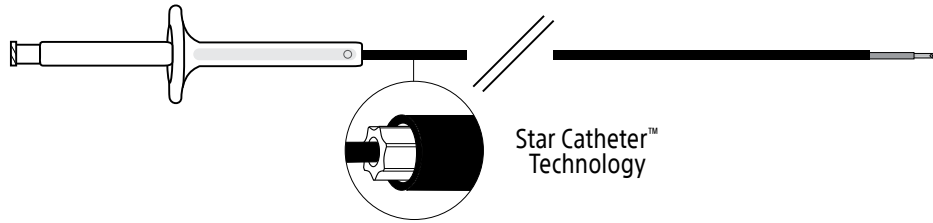

Interject™ Contrast Single-Use Injection Therapy Needle Catheters*



Order Number	GTIN	Sheath Design	Needle Gauge	Maximum Needle Extension Length (mm)	Sheath O.D. (mm)	Working Length (cm)	Packaging
M00518151	08714729296430	Contrast	23	4	1.8	200	Box 5
M00518161	08714729296447	Contrast	25	4	1.8	200	Box 5
M00518251	08714729296478	Contrast	23	6	1.8	200	Box 5
M00518261	08714729296485	Contrast	25	6	1.8	200	Box 5
M00518351	08714729296522	Contrast	23	4	2.3	240	Box 5
M00518361	08714729296539	Contrast	25	4	2.3	240	Box 5

*With Star Catheter Technology.

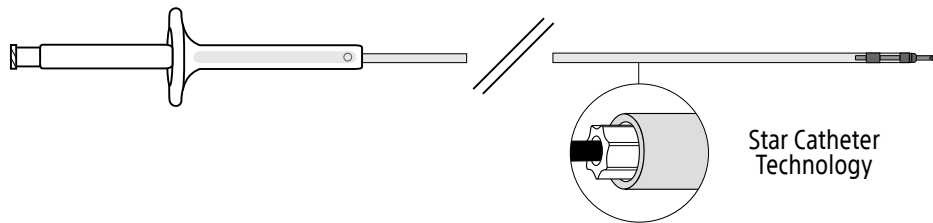

Interject™ Clear Single-Use Injection Therapy Needle Catheters*



Order Number	GTIN	Sheath Design	Needle Gauge	Maximum Needle Extension Length (mm)	Sheath O.D. (mm)	Working Length (cm)	Packaging
M00518101	08714729296416	Clear	23	4	1.8	200	Box 5
M00518111	08714729296423	Clear	25	4	1.8	200	Box 5
M00518301	08714729296508	Clear	23	4	2.3	240	Box 5
M00518311	08714729296515	Clear	25	4	2.3	240	Box 5

*With Star Catheter Technology.

MULTIPLE BAND LIGATORS

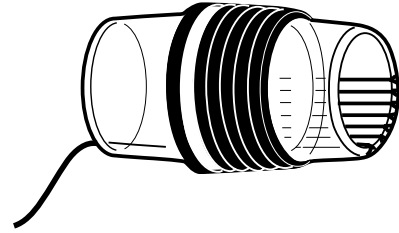
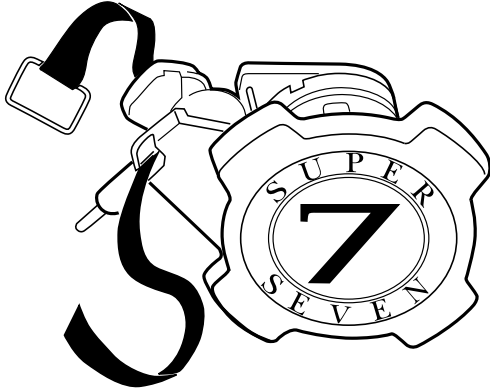

Speedband Superview Super 7™ Multiple Band Ligators



Order Number	GTIN	Description	Required Working Channel (mm)	Scope O.D. (mm)	Bands / Ligating Unit	Packaging
M00542250	08714729201953	Speedband Superview Super 7 Band Ligator	2.8	8.6 - 11.5	7	Each
M00542251	08714729201960	Speedband Superview Super 7 Band Ligator	2.8	8.6 - 11.5	7	Box 2
M00542253	08714729504832	Speedband Superview Super 7 Band Ligator	2.8	8.6 - 11.5	7	Box 4

ELECTROSURGICAL BIPOLAR CABLE ADAPTER

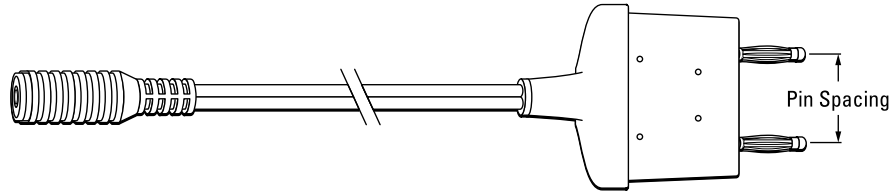

Electrosurgical Bipolar Cable Adapter*

Order Number	GTIN	Description	Pin Spacing (mm)	Generator Compatibility**	Packaging
M00561450	08714729797616	Bipolar Cable Adapter	22	ERBE, EMC Dolley	Each
M00561470	08714729797630	Bipolar Cable Adapter	28	Valleylab™, Lamidey (Duo), Bovie™ (Aaron 3250™), Olympus (ESG100, PSD60, UES10, UES30 & Surgemaster), Bowa, Soring	Each
M00561480	08714729797647	Bipolar Cable Adapter	28 / Third Pin	ConMed™ (System 5000), Bovie (Aaron 2250™), Ethicon™	Each

*Bipolar Cable Adapters are used to connect Gold Probe™ and Injection Gold Probe™ Catheters with the above mentioned generators.

Bipolar Cable Adapters are not required for the connection of Gold Probe and Injection Gold Probe to Endostat™ II or III Generators.

**For generators and their associated cable adapters not listed above, please contact your Boston Scientific Representative.

Note: Monopolar active cords are in the Resection & Retrieval Section, [▶](#) (See page 82).

Note: Some variations in generator faceplates may exist within a generator model. We recommend that you confirm pin spacing prior to ordering.

Defect Closure

Defect Closure

▶ X-Tack™	53
▶ Suture Cinch - Long	53

Clipping Devices

▶ MANTIS™ Clip	54
▶ Resolution 360™ ULTRA Clip	54
▶ Resolution 360™ Clip	54
▶ Resolution™ Clip	55

► Defect Closure

DEFECT CLOSURE

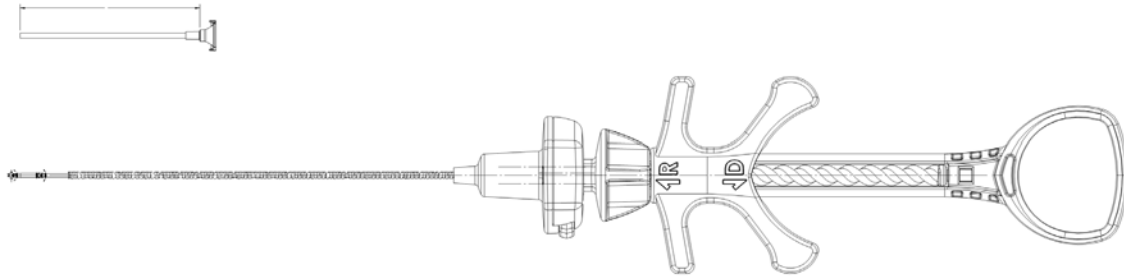

X-Tack™ Helical Tacking System ⓧ				
SKU	GTIN	Description	Working Length	Packaging
M00505500		Gastric Length (Compatible with a 2.8mm+ scope channel)	160 cm	Each
M00505510		Colonic Length (Compatible with a 2.8mm+ scope channel)	235 cm	Each

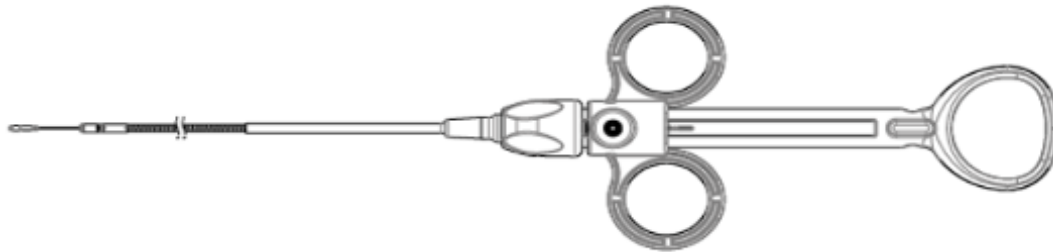

Suture Cinch - Long ⓧ				
SKU	GTIN	Description	Working Length	Packaging
M00505550	00191506049188	Suture Cinch - Long	230cm	Each

▶ Defect Closure

CLIPPING DEVICES

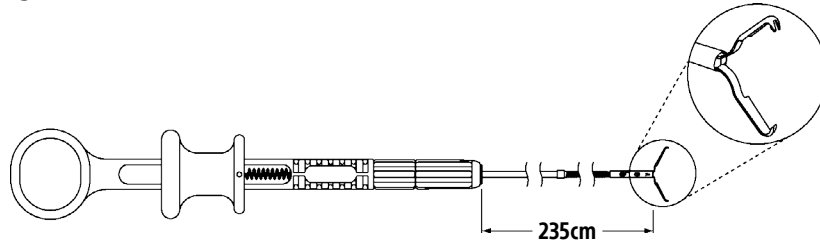

MANTIS™ Clip



Order Number	GTIN	Working Length (cm)	Minimum Working Channel (mm)	Packaging
M00521420	00191506023591	235	2.8	Each
M00521421	00191506023607	235	2.8	Box 10
M00521422	00191506023614	235	2.8	Box 20

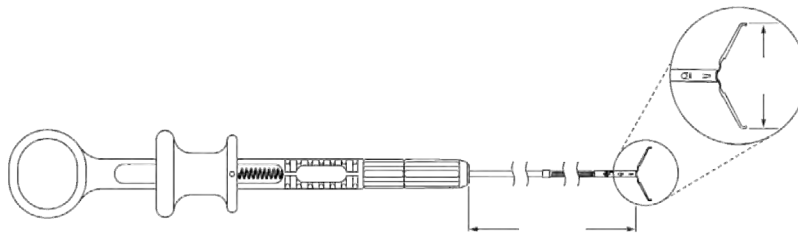

Resolution 360™ ULTRA Clip



Order Number	GTIN	Working Length (cm)	Minimum Working Channel (mm)	Clip Opening (mm)	Packaging
M00521400	08714729997245	235	2.8	17	Each
M00521401	08714729997252	235	2.8	17	Box 10
M00521402	08714729997269	235	2.8	17	Box 20
M00521403	08714729997276	235	2.8	17	Box 40



 Magnetic Resonance Conditional¹

Resolution 360™ Clip



Order Number	GTIN	Working Length (cm)	Minimum Working Channel (mm)	Clip Opening (mm)	Packaging
M00521240	08714729875666	155	2.8	11	Each
M00521241	08714729875673	155	2.8	11	Box 10
M00521242	08714729875680	155	2.8	11	Box 20
M00521230	08714729875628	235	2.8	11	Each
M00521231	08714729875635	235	2.8	11	Box 10
M00521232	08714729875642	235	2.8	11	Box 20
M00521233	08714729875659	235	2.8	11	Box 40

¹Product with this symbol may be used in Magnetic Resonance environment according to the conditions described in Directions for Use.

► Defect Closure

CLIPPING DEVICES (Continued)

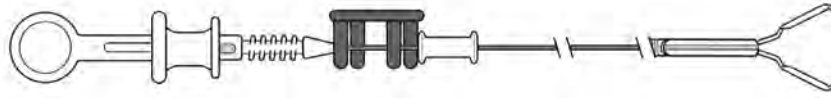

Resolution™ Clip Ⓜ					
Order Number	GTIN	Working Length (cm)	Minimum Working Channel (mm)	Clip Opening (mm)	Packaging
M00522600	08714729504764	155	2.8	11	Each
M00522601	08714729504771	155	2.8	11	Box 10
M00522602	08714729504788	155	2.8	11	Box 20
M00522610	08714729504795	235	2.8	11	Each
M00522611	08714729504801	235	2.8	11	Box 10
M00522612	08714729504818	235	2.8	11	Box 20

¹Product with this symbol may be used in Magnetic Resonance environment according to the conditions described in Directions for Use.

Endobariatrics

Endobariatrics

▶ Orbera™ Intragastric Balloon System	56
▶ Intragastric Balloon Removal Kit	56
▶ OverStitch™ Endoscopic Suturing System	57
▶ OverStitch NXT™ NeXT Generation Single Channel Endoscopic Suturing System	57
▶ OverStitch 2-0 Polypropylene Suture	58
▶ OverStitch Suture Cinch	58
▶ Suture Cinch - Long	58
▶ OverStitch Tissue Helix	59
▶ OverStitch NXT Tissue Helix Pro	59
▶ OverTube Endoscopic Access System	60
▶ Ensizor Endoscopic Scissors	60

► Endobariatrics

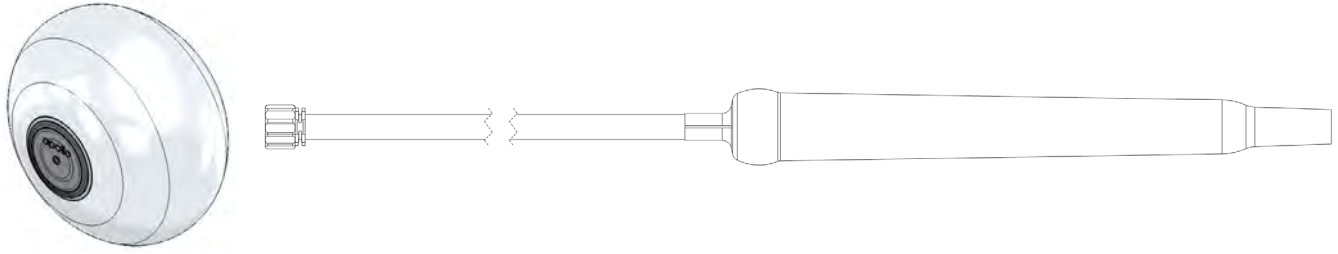

Orbera™ IntraGastric Balloon System



UPN	GTIN	Regions	Product Description	System Contents	SAP Description	Qty per Pack
B-4800	10811955020619	US only	Endoscopically placed intraGastric balloon system designed to help adults with obesity lose weight.	Sheath Kit & Fill Kit	Orbera 6 month US Only Balloon	1

IntraGastric Balloon Removal Kit



UPN	GTIN	Regions	Product Description	Kit Contents	SAP Description	Qty per Pack
B-4815		US only	Instruments required to endoscopically remove the Orbera IntraGastric Balloon System	5 X AS2640718 - Aspiration Needle; 5 X AS2290718 - Extraction Forceps	Extraction Kit US Only	5

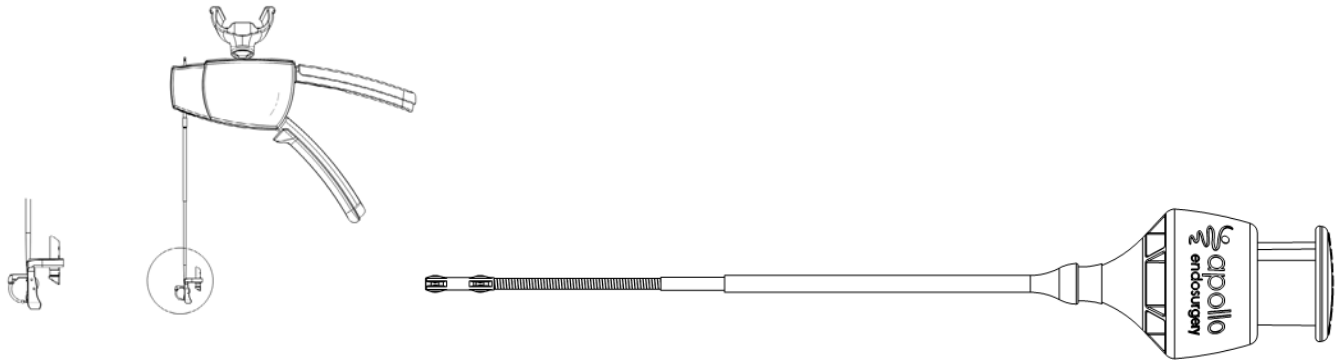

OverStitch™ Endoscopic Suturing System



Order Number	GTIN	Working Length	Helix Offset (Hx)	Bite Width (Bw)	Tower Height (Th)	Tower Diameter Open (To)	Tower Diameter Closed (Tc)*	Packaging
M00505410	00191506060138	122 cm (48 in)	3.6 mm (2TH180 Scope) 3.9 mm (Olympus 2T160 Scope)	5 mm	18.4 mm	23.3 mm	15.8 mm (12.2 - 13.2 mm Scope Diameter)	Qty. 1 Unit

*Mounted on scope. With the Endoscopic Suturing System installed, the endoscope's effective outer diameter is increased by approximately 7 mm.

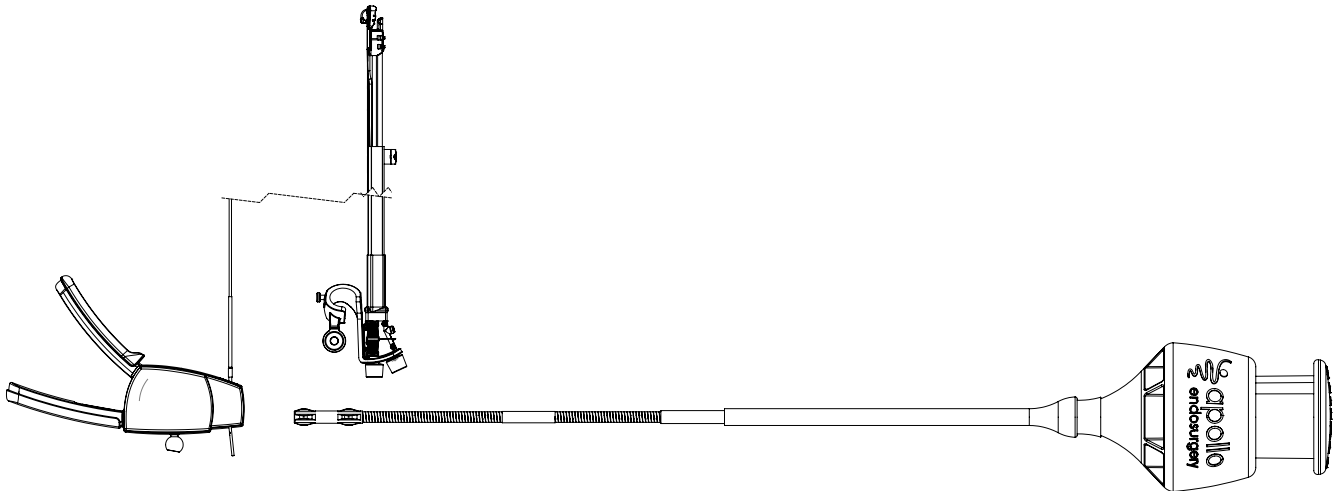

OverStitch NXT™ NeXT Generation Single Channel Endoscopic Suturing System



Order Number	GTIN	Working Length	Helix Offset (Hx)	Bite Width (Bw)	Tower Height (Th)	Tower Diameter Open (To)	Tower Diameter Closed (Tc)*	Packaging
M00505430	00191506060107	127 cm (50 in)	2.6 mm	5 mm	19.8 mm	21.1 mm	15.8 mm - 16.8 mm (12.2 - 13.2 mm Scope Diameter)	Qty. 1 Unit

*Mounted on scope. With the Endoscopic Suturing System installed, the endoscope's effective outer diameter is increased by approximately 7 mm.

▶ Endobarietrics

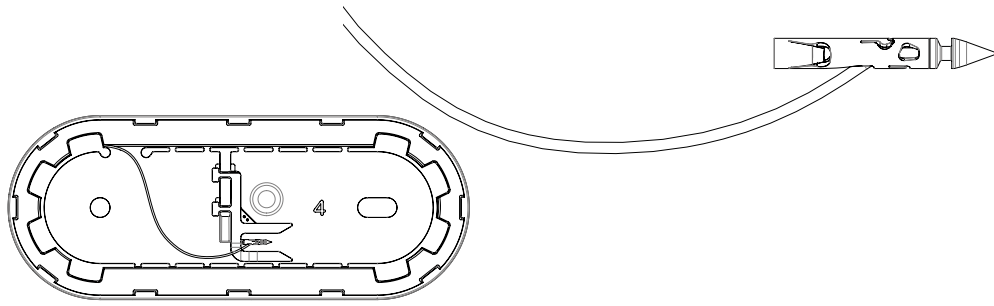

OverStitch™ 2-0 Polypropylene Suture



Order Number	GTIN	Working Length	Packaging
M00505451	00191506060138	183cm	Box 12

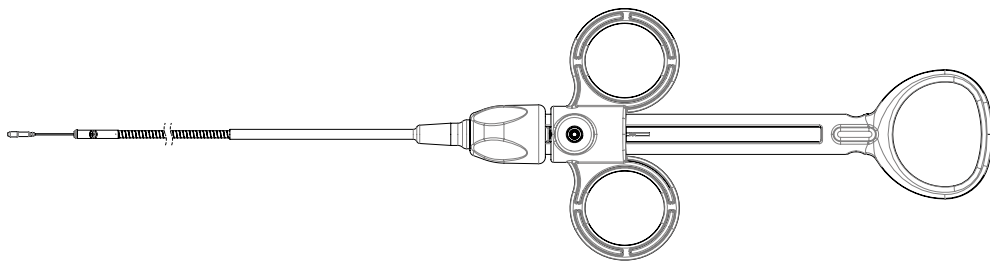

OverStitch™ Suture Cinch



Order Number	GTIN	Working Length	Packaging
M00505530	00191506060046	170cm	Each

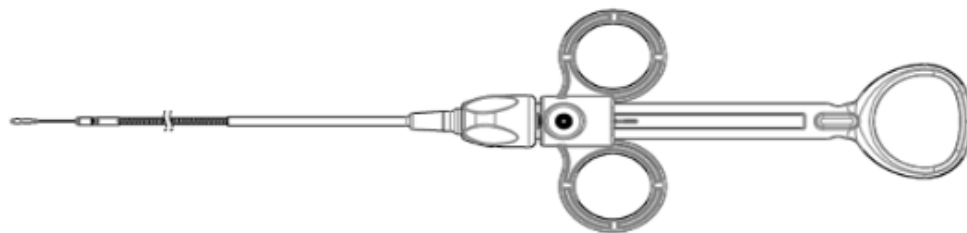

Suture Cinch - Long



Order Number	GTIN	Working Length	Packaging
M00505550	00191506049188	230cm	Each

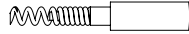
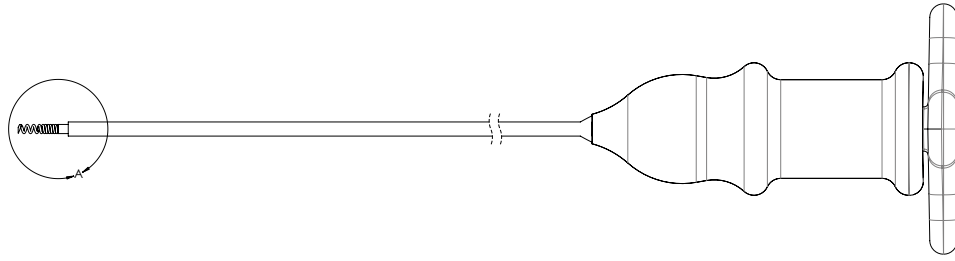

OverStitch™ Tissue Helix ⓧ

Order Number	GTIN	Working Length	Helix Depth	Packaging
M00505460	00191506060053	165cm	3.8mm	Each

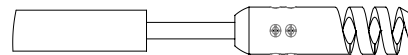
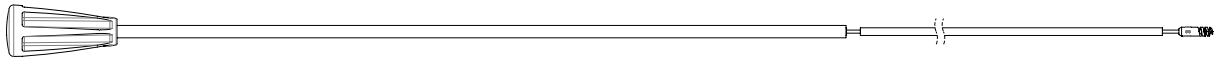

OverStitch NXT™ Tissue Helix Pro ⓧ

Order Number	GTIN	Working Length	Helix Depth	Packaging
M00505490	00191506060060	130cm	4.2mm	Qty. 1 Unit

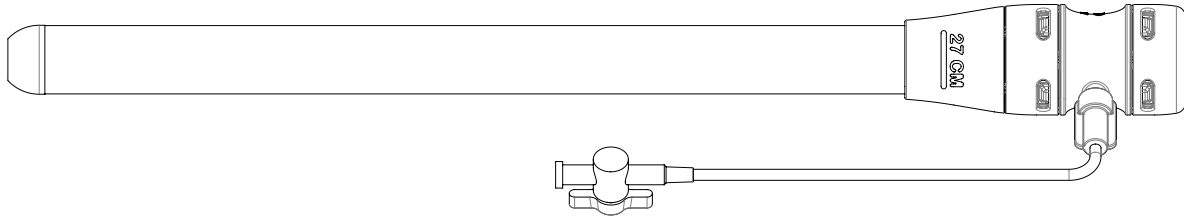

OverTube™ Endoscopic Access System



Order Number	GTIN	Working Length	Outer Diameter	Inner Diameter	Packaging
M00505560	00191506060053	27cm	19.5mm	17.7mm	Each

Ensizor Endoscopic Scissors



SKU	GTIN	Description	Working Length	Packaging
ES26165-3		Gastric Length	165 cm / 65 in	Qty. 3 Units
ES26235-3		Colonic Length	235 cm / 93 in	Qty. 3 Units



Dilation

CRE™ Balloon Dilatation Catheters

- CRE Fixed Wire Esophageal Balloon Dilatation Catheters 61
- CRE PRO Wireguided Esophageal / Pyloric / Biliary Balloon Dilatation Catheters 62
- CRE PRO Wireguided Esophageal / Pyloric / Colonic / Biliary Balloon Dilatation Catheters 62
- CRE RX Biliary Balloon Dilatation Catheters 63
- CRE Wireguided Esophageal / Pyloric Balloon Dilatation Catheters 63
- CRE Wireguided Esophageal / Pyloric / Colonic Balloon Dilatation Catheters 64

Rigiflex™ II Single-Use Achalasia Balloon Dilatation Catheter

- Rigiflex II Single-Use Achalasia Balloon Dilators 65

Inflation Systems and Dilation Accessories

- Alliance™ II Integrated Inflation / Lithotripsy Device 66
- Pneumatic Inflator / Deflation Devices and Accessories 66

CRE™ BALLOON DILATATION CATHETERS

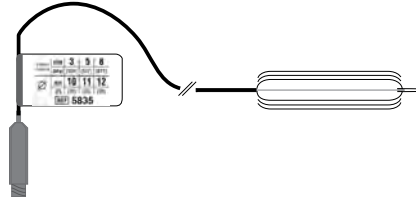

CRE Fixed Wire Esophageal Balloon Dilatation Catheters



Order Number	GTIN	Balloon Inflated O.D.		Balloon Length (cm)	Inflation Pressures		Minimum Working Channel (mm)	Catheter Size (Fr)	Working Length (cm)	Packaging
		(mm)	(Fr)		(atm)	(kPa)				
M00558330	08714729201984	6-7-8	18-21-24	8	3-6-10	304-608-1013	2.8	6	180	Each
M00558340	08714729201991	8-9-10	24-27-30	8	3-5.5-9	304-557-912	2.8	6	180	Each
M00558350	08714729202004	10-11-12	30-33-36	8	3-5-8	304-507-811	2.8	6	180	Each
M00558360	08714729195986	12-13.5-15	36-40.5-45	8	3-4.5-8	304-456-811	2.8	6	180	Each
M00558370	08714729195993	15-16.5-18	45-49.5-54	8	3-4.5-7	304-456-709	2.8	6	180	Each
M00558380	08714729202011	18-19-20	54-57-60	8	3-4.5-6	304-456-608	2.8	6	180	Each
M00558361	08714729339298	12-13.5-15	36-40.5-45	8	3-4.5-8	304-456-811	2.8	6	180	Box 5
M00558371	08714729339304	15-16.5-18	45-49.5-54	8	3-4.5-7	304-456-709	2.8	6	180	Box 5
M00558381	08714729339311	18-19-20	54-57-60	8	3-4.5-6	304-456-608	2.8	6	180	Box 5

Recommended Inflation Device: Alliance™ II Integrated Inflation / Lithotripsy Device Order #5062, Alliance II Single-Use Syringe / Gauge Assembly Order #5060,  (See page 94).

CRE™ PRO WIREGUIDED BALLOON DILATATION CATHETERS

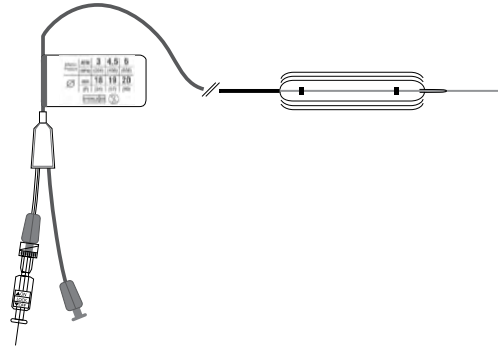

CRE PRO Wireguided Esophageal / Pyloric / Biliary Balloon Dilatation Catheters



Order Number	GTIN	Balloon Inflated O.D.		Balloon Length (cm)	Inflation Pressures		Minimum Working Channel (mm)	Catheter Size (Fr)	Working Length (cm)	Packaging
		(mm)	(Fr)		(atm)	(kPa)				
M00558600	08714729797487	6-7-8	18-21-24	5.5	3-6-10	304-608-1013	2.8 / 3.2*	7.5	180	Each
M00558610	08714729797494	8-9-10	24-27-30	5.5	3-5.5-9	304-557-912	2.8 / 3.2*	7.5	180	Each
M00558620	08714729797500	10-11-12	30-33-36	5.5	3-5-8	304-507-811	2.8 / 3.2*	7.5	180	Each
M00558630	08714729797517	12-13.5-15	36-40.5-45	5.5	3-4.5-8	304-456-811	2.8 / 3.2*	7.5	180	Each
M00558640	08714729797524	15-16.5-18	45-49.5-54	5.5	3-4.5-7	304-456-709	2.8 / 3.7*	7.5	180	Each
M00558650**	08714729797531	18-19-20	54-57-60	5.5	3-4.5-6	304-456-608	2.8 / 3.7*	7.5	180	Each

Recommended Inflation Device: Alliance™ II Integrated Inflation / Lithotripsy Device Order #5062, Alliance II Single-Use Syringe / Gauge Assembly Order #5060,

(See page 94).

Guidewire included and preloaded in balloon dilatation catheter.

*Duodenoscope channel size.

**Esophageal and Biliary application only.

CRE PRO Wireguided Esophageal / Pyloric / Colonic / Biliary Balloon Dilatation Catheters



Order Number	GTIN	Balloon Inflated O.D.		Balloon Length (cm)	Inflation Pressures		Minimum Working Channel (mm)	Catheter Size (Fr)	Working Length (cm)	Packaging
		(mm)	(Fr)		(atm)	(kPa)				
M00558660	08714729797548	6-7-8	18-21-24	5.5	3-6-10	304-608-1013	2.8 / 3.2*	7.5	240	Each
M00558670	08714729797555	8-9-10	24-27-30	5.5	3-5.5-9	304-557-912	2.8 / 3.2*	7.5	240	Each
M00558680	08714729797562	10-11-12	30-33-36	5.5	3-5-8	304-507-811	2.8 / 3.2*	7.5	240	Each
M00558690	08714729797579	12-13.5-15	36-40.5-45	5.5	3-4.5-8	304-456-811	2.8 / 3.2*	7.5	240	Each
M00558700	08714729797586	15-16.5-18	45-49.5-54	5.5	3-4.5-7	304-456-709	2.8 / 3.7*	7.5	240	Each
M00558710**	08714729797593	18-19-20	54-57-60	5.5	3-4.5-6	304-456-608	2.8 / 3.7*	7.5	240	Each

Recommended Inflation Device: Alliance II Integrated Inflation / Lithotripsy Device Order #5062, Alliance II Single-Use Syringe / Gauge Assembly Order #5060,

(See page 94).

Guidewire included and preloaded in balloon dilatation catheter.

*Duodenoscope channel size.

**Esophageal, Colonic and Biliary application only.

CRE™ RX BILIARY BALLOON DILATATION CATHETERS

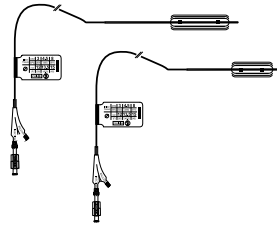

CRE RX Biliary Balloon Dilatation Catheters*

Order Number	GTIN	Balloon Inflated O.D.		Balloon Length (cm)	Inflation Pressures		Minimum Working Channel (mm)	Catheter Size (Fr)	Working Length (cm)	Packaging
		(mm)	(Fr)		(atm)	(kPa)				
M00558860	08714729965411	6-7-8	18-21-24	5.5	3-6-10	304-608-1013	3.7	7.5	180	Each
M00558870	08714729965428	8-9-10	24-27-30	5.5	3-5.5-9	304-557-912	3.7	7.5	180	Each
M00558880	08714729965435	10-11-12	30-33-36	5.5	3-5-8	304-507-811	3.7	7.5	180	Each
M00558890	08714729965442	12-13.5-15	36-40.5-45	5.5	3-4.5-8	304-456-811	3.7	7.5	180	Each
M00558900	08714729965459	15-16.5-18	45-49.5-54	5.5	3-4.5-7	304-456-709	3.7	7.5	180	Each
M00558910	08714729965466	18-19-20	54-57-60	5.5	3-4.5-6	304-456-608	3.7	7.5	180	Each
M00558920	08714729965473	8-9-10	24-27-30	3.0	3-5.5-9	304-608-1013	3.7	7.5	180	Each
M00558930	08714729965480	10-11-12	30-33-36	3.0	3-5-8	304-557-912	3.7	7.5	180	Each
M00558940	08714729965497	12-13.5-15	36-40.5-45	3.0	3-4.5-8	304-507-811	3.7	7.5	180	Each

Recommended Inflation Device: Alliance™ II Integrated Inflation / Lithotripsy Device Order #5062, Alliance II Single-Use Syringe / Gauge Assembly Order #5060, (See page 94).

*No Pre-loaded Guidewire in the Balloon Dilatation Catheter.

CRE™ WIREGUIDED BALLOON DILATATION CATHETERS

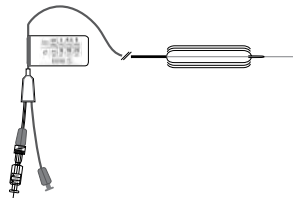

CRE Wireguided Esophageal / Pyloric Balloon Dilatation Catheters

Order Number	GTIN	Balloon Inflated O.D.		Balloon Length (cm)	Inflation Pressures		Minimum Working Channel (mm)	Catheter Size (Fr)	Working Length (cm)	Packaging
		(mm)	(Fr)		(atm)	(kPa)				
M00558390	08714729339328	6-7-8	18-21-24	5.5	3-6-10	304-608-1013	2.8	7.5	180	Each
M00558400	08714729339335	8-9-10	24-27-30	5.5	3-5.5-9	304-557-912	2.8	7.5	180	Each
M00558410	08714729339342	10-11-12	30-33-36	5.5	3-5-8	304-507-811	2.8	7.5	180	Each
M00558420	08714729339359	12-13.5-15	36-40.5-45	5.5	3-4.5-8	304-456-811	2.8	7.5	180	Each
M00558430	08714729339366	15-16.5-18	45-49.5-54	5.5	3-4.5-7	304-456-709	2.8	7.5	180	Each
M00558440*	08714729339373	18-19-20	54-57-60	5.5	3-4.5-6	304-456-608	2.8	7.5	180	Each

Recommended Inflation Device: Alliance™ II Integrated Inflation / Lithotripsy Device Order #5062, Alliance II Single-Use Syringe / Gauge Assembly Order #5060, (See page 94).

Guidewire included and preloaded in balloon dilatation catheter.

*Esophageal application only.

Dilation

CRE™ WIREGUIDED BALLOON DILATATION CATHETERS (Continued)

CRE Wireguided Esophageal / Pyloric / Colonic Balloon Dilatation Catheters



Order Number	GTIN	Balloon Inflated O.D.		Balloon Length (cm)	Inflation Pressures		Minimum Working Channel (mm)	Catheter Size (Fr)	Working Length (cm)	Packaging
		(mm)	(Fr)		(atm)	(kPa)				
M00558450	08714729339380	6-7-8	18-21-24	5.5	3-6-10	304-608-1013	2.8	7.5	240	Each
M00558460	08714729339397	8-9-10	24-27-30	5.5	3-5.5-9	304-557-912	2.8	7.5	240	Each
M00558470	08714729339403	10-11-12	30-33-36	5.5	3-5-8	304-507-811	2.8	7.5	240	Each
M00558480	08714729339410	12-13.5-15	36-40.5-45	5.5	3-4.5-8	304-456-811	2.8	7.5	240	Each
M00558490	08714729339427	15-16.5-18	45-49.5-54	5.5	3-4.5-7	304-456-709	2.8	7.5	240	Each
M00558500*	08714729339434	18-19-20	54-57-60	5.5	3-4.5-6	304-456-608	2.8	7.5	240	Each

Recommended Inflation Device: Alliance II Integrated Inflation / Lithotripsy Device Order #5062, Alliance II Single-Use Syringe / Gauge Assembly Order #5060, (See page 94).

Guidewire included and preloaded in balloon dilatation catheter.

*Esophageal and Colonic application only.

► Dilation

RIGIFLEX™ II SINGLE-USE ACHALASIA BALLOON DILATATION CATHETER

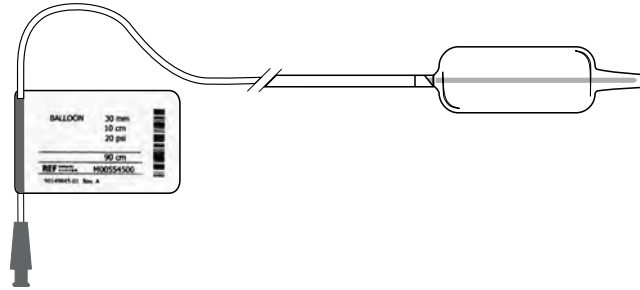

Rigiflex II Single-Use Achalasia Balloon Dilators*



Order Number	GTIN	Balloon Inflated O.D.		Balloon Length (cm)	Inflation Pressures		Working Length (cm)	Catheter Size		Recommended Guidewire** (in)	Packaging
		(mm)	(Fr)		(psi)	(kPa)		(mm)	(Fr)		
M0054500	08714729719106	30	90	10	20	138	90	4.6	14	.038	Each
M0054510	08714729719113	35	105	10	20	138	90	4.6	14	.038	Each
M0054520	08714729719120	40	120	10	20	138	90	4.6	14	.038	Each

*Product Shipped Sterile. Recommended use with Pneumatic Inflator Order #5320,  (See page 66).

**Guidewire included with Rigiflex II Balloon Dilation Catheter.

INFLATION SYSTEMS AND DILATION ACCESSORIES

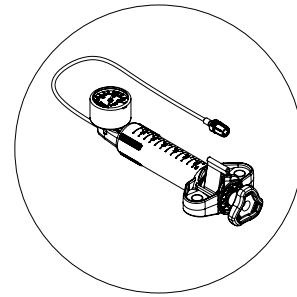
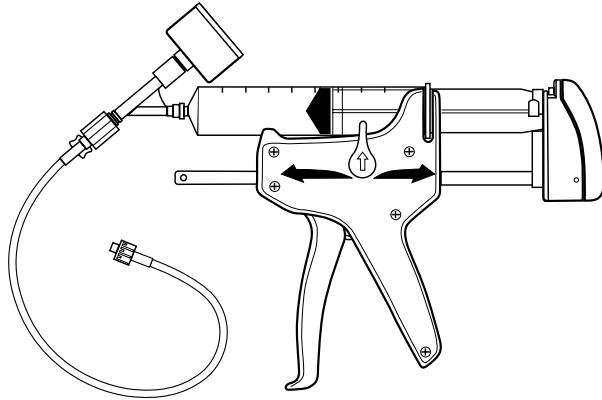

Alliance™ II Single-Use Syringe / Gauge Assembly / Integrated Inflation / Lithotripsy Device

Order Number	GTIN	Description	Packaging
M00550620	08714729283881	Alliance II Integrated Inflation / Lithotripsy Device	Each
M00550601	08714729129332	⊗ Alliance II Single-Use Syringe / Gauge Assembly	Box 5

Inflation / Deflation Devices and Accessories

Order Number	GTIN	Description	Packaging
M00553200	08714729195450	Pneumatic Inflator	Each
M00550630	00856877002506	CRE™ SteriFlate Disposable Inflation Device	Each



Biopsy

Forceps

- ▶ Radial Jaw™ 4 Single-Use Hot Biopsy Forceps67
- ▶ Radial Jaw 4 Single-Use Jumbo Biopsy Forceps67
- ▶ Radial Jaw 4 Single-Use Large Capacity Biopsy Forceps67
- ▶ Radial Jaw 4 Single-Use Pediatric Biopsy Forceps 68
- ▶ Radial Jaw 4 Single-Use Standard Capacity Biopsy Forceps.... 68

FORCEPS

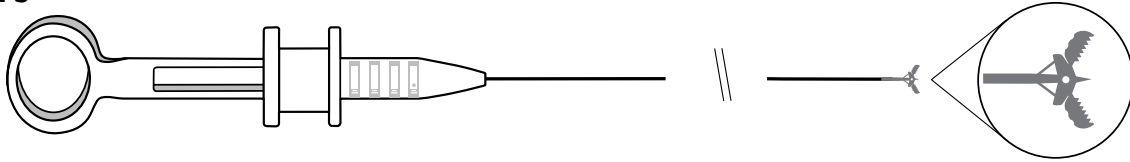

Radial Jaw™ 4 Single-Use Jumbo Biopsy Forceps



Order Number	GTIN	Description	Jaw O.D. (mm)	Working Length (cm)	Minimum Working Channel (mm)	Color Code	Packaging
M00513343	08714729761891	Radial Jaw 4 Jumbo Forceps	2.8	160	3.2	Yellow	Box 5
M00513353	08714729761907	Radial Jaw 4 Jumbo Forceps w/ Needle	2.8	160	3.2	Yellow	Box 5
M00513363	08714729761914	Radial Jaw 4 Jumbo Forceps	2.8	240	3.2	Orange	Box 5
M00513373	08714729761938	Radial Jaw 4 Jumbo Forceps w/ Needle	2.8	240	3.2	Orange	Box 5
M00513361	08714729648871	Radial Jaw 4 Jumbo Forceps	2.8	240	3.2	Orange	Box 20
M00513371	08714729648895	Radial Jaw 4 Jumbo Forceps w/ Needle	2.8	240	3.2	Orange	Box 20
M00513362	08714729648888	Radial Jaw 4 Jumbo Forceps	2.8	240	3.2	Orange	Box 40
M00513372	08714729648901	Radial Jaw 4 Jumbo Forceps w/ Needle	2.8	240	3.2	Orange	Box 40

Radial Jaw 4 Single-Use Large Capacity Biopsy Forceps



Order Number	GTIN	Description	Jaw O.D. (mm)	Working Length (cm)	Minimum Working Channel (mm)	Color Code	Packaging
M00513303	08714729761839	Radial Jaw 4 Large Capacity Forceps	2.4	160	2.8	Yellow	Box 5
M00513313	08714729761853	Radial Jaw 4 Large Capacity Forceps w/ Needle	2.4	160	2.8	Yellow	Box 5
M00513323	08714729761877	Radial Jaw 4 Large Capacity Forceps	2.4	240	2.8	Orange	Box 5
M00513333	08714729755494	Radial Jaw 4 Large Capacity Forceps w/ Needle	2.4	240	2.8	Orange	Box 5
M00513301	08714729648758	Radial Jaw 4 Large Capacity Forceps	2.4	160	2.8	Yellow	Box 20
M00513311	08714729648772	Radial Jaw 4 Large Capacity Forceps w/ Needle	2.4	160	2.8	Yellow	Box 20
M00513321	08714729648796	Radial Jaw 4 Large Capacity Forceps	2.4	240	2.8	Orange	Box 20
M00513331	08714729648819	Radial Jaw 4 Large Capacity Forceps w/ Needle	2.4	240	2.8	Orange	Box 20
M00513302	08714729648765	Radial Jaw 4 Large Capacity Forceps	2.4	160	2.8	Yellow	Box 40
M00513312	08714729648789	Radial Jaw 4 Large Capacity Forceps w/ Needle	2.4	160	2.8	Yellow	Box 40
M00513322	08714729648802	Radial Jaw 4 Large Capacity Forceps	2.4	240	2.8	Orange	Box 40
M00513332	08714729648826	Radial Jaw 4 Large Capacity Forceps w/ Needle	2.4	240	2.8	Orange	Box 40

Radial Jaw 4 Single-Use Standard Capacity Biopsy Forceps



Order Number	GTIN	Description	Jaw O.D. (mm)	Working Length (cm)	Minimum Working Channel (mm)	Color Code	Packaging
M00513383	08714729777915	Radial Jaw 4 Standard Capacity Forceps	2.2	160	2.8	Yellow	Box 5
M00513393	08714729777939	Radial Jaw 4 Standard Capacity Forceps w/ Needle	2.2	160	2.8	Yellow	Box 5
M00513403	08714729777922	Radial Jaw 4 Standard Capacity Forceps	2.2	240	2.8	Orange	Box 5
M00513413	08714729777946	Radial Jaw 4 Standard Capacity Forceps w/ Needle	2.2	240	2.8	Orange	Box 5
M00513381	08714729777953	Radial Jaw 4 Standard Capacity Forceps	2.2	160	2.8	Yellow	Box 20
M00513391	08714729777977	Radial Jaw 4 Standard Capacity Forceps w/ Needle	2.2	160	2.8	Yellow	Box 20
M00513401	08714729777960	Radial Jaw 4 Standard Capacity Forceps	2.2	240	2.8	Orange	Box 20
M00513411	08714729777984	Radial Jaw 4 Standard Capacity Forceps w/ Needle	2.2	240	2.8	Orange	Box 20
M00513382	08714729778011	Radial Jaw 4 Standard Capacity Forceps	2.2	160	2.8	Yellow	Box 40
M00513392	08714729777991	Radial Jaw 4 Standard Capacity Forceps w/ Needle	2.2	160	2.8	Yellow	Box 40
M00513402	08714729778028	Radial Jaw 4 Standard Capacity Forceps	2.2	240	2.8	Orange	Box 40
M00513412	08714729778004	Radial Jaw 4 Standard Capacity Forceps w/ Needle	2.2	240	2.8	Orange	Box 40

► Biopsy

FORCEPS (Continued)

Radial Jaw™ 4 Single-Use Pediatric Biopsy Forceps



Order Number	GTIN	Description	Jaw O.D. (mm)	Working Length (cm)	Minimum Working Channel (mm)	Color Code	Packaging
M00513443	08714729790211	Radial Jaw 4 Pediatric Biopsy Forceps	1.8	160	2.0	Yellow	Box 5
M00513453	08714729790228	Radial Jaw 4 Pediatric Biopsy Forceps w/ Needle	1.8	160	2.0	Yellow	Box 5

HOT BIOPSY FORCEPS

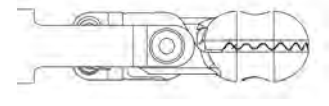
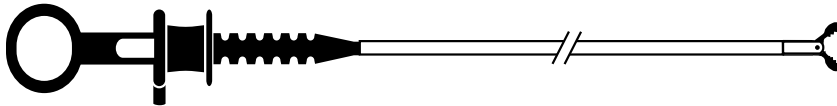

Radial Jaw 4 Single-Use Hot Biopsy Forceps



Order Number	GTIN	Description	Jaw O.D. (mm)	Working Length (cm)	Minimum Working Channel (mm)	Color Code	Packaging
M00515031	08714729790136	Radial Jaw 4 Hot Biopsy Forceps	2.2	240	2.8	Red	Box 5
M00515032	08714729790105	Radial Jaw 4 Hot Biopsy Forceps	2.2	240	2.8	Red	Box 20
M00515033	08714729790143	Radial Jaw 4 Hot Biopsy Forceps	2.2	240	2.8	Red	Box 40



EndoVive™ Enteral Access Devices

Percutaneous Endoscopic Gastrostomy (PEG) Devices with ENFit™

Initial Placement Peg Kits with ENFit

- ▶ Safety PEG Kit with ENFit 69
- ▶ Standard PEG Kit with ENFit 69
- ▶ Initial Placement PEG Accessories with ENFit 69

One-Step Button™ Low Profile Initial Placement PEG Kits and Accessories with ENFit

- ▶ One-Step Button Low Profile PEG Kits with ENFit 70
- ▶ One-Step Button and Low Profile Replacement Button Accessories with ENFit 70

Replacement Gastrostomy Tubes (G-Tube) with ENFit

- ▶ Replacement G-Tubes, Straight Bolster, with ENFit 71
- ▶ Replacement G-Tubes, Right Angle Bolster, with ENFit 71

Low Profile Replacement Buttons and Accessories with ENFit

- ▶ Low Profile Replacement Button with ENFit 71
- ▶ One-Step Button and Low Profile Replacement Button Accessories with ENFit 71

ENFit Transition Connectors

- ▶ ENFit Transition Connectors 72

Percutaneous Endoscopic Gastrostomy (PEG) Devices

Initial Placement PEG Kits

- ▶ Safety PEG Kit 73
- ▶ Standard PEG Kit 73
- ▶ Initial Placement PEG Accessories 73

Initial Placement Low Profile PEG Kits

- ▶ One-Step Button Low Profile PEG Kits 74
- ▶ One-Step Button and Low Profile Replacement Button Accessories 74

Replacement Gastrostomy Tubes (G-Tube)

- ▶ Replacement G-Tubes, Straight Bolster 75
- ▶ Replacement G-Tubes, Right Angle Bolster 75

Low Profile Replacement Buttons and Accessories

- ▶ Low Profile Replacement Button 76
- ▶ One-Step Button and Low Profile Replacement Button Accessories 76

Jejunal Feeding Tube Devices

- ▶ Through-The-PEG (TTP) Jejunal Feeding Tube 76

EndoVive™ Enteral Access Devices

INITIAL PLACEMENT PEG KITS WITH ENFIT™†

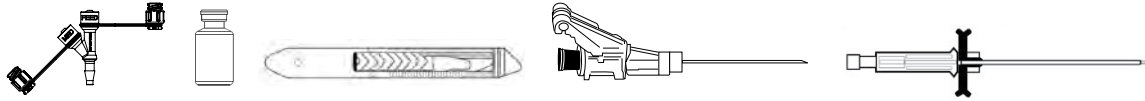

Safety PEG* Kit with ENFit



Order Number	GTIN	Description	Packaging
M00509001	08714729880394	20Fr Safety PEG Kit, Pull with ENFit	Box 2
M00509011	08714729880417	20Fr Safety PEG Kit, Push with ENFit	Box 2
M00509021	08714729880431	24Fr Safety PEG Kit, Pull with ENFit	Box 2
M00509031	08714729880455	24Fr Safety PEG Kit, Push with ENFit	Box 2

*Includes local anesthetic.

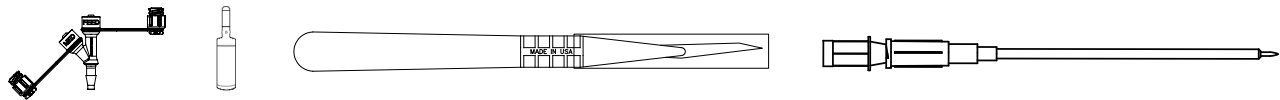

Standard PEG* Kit with ENFit



Order Number	GTIN	Description	Packaging
M00509041	08714729880479	20Fr Standard PEG Kit, Pull with ENFit	Box 2
M00509051	08714729880493	20Fr Standard PEG Kit, Push with ENFit	Box 2
M00509061	08714729880516	24Fr Standard PEG Kit, Pull with ENFit	Box 2
M00509071	08714729880530	24Fr Standard PEG Kit, Push with ENFit	Box 2

*Includes local anesthetic.

Initial Placement PEG Accessories with ENFit



Order Number	GTIN	Description	Packaging
M00501261	08714729863564	20Fr Y-Ports with ENFit	Box 10
M00501271	08714729863588	24Fr Y-Ports with ENFit	Box 10

†NOTE: Make sure all appropriate service lines in your healthcare system are ready to use ENFit enteral connectors. Please contact your Boston Scientific Sales Representative for support with ENFit enteral connectors.

Recommended ENFit Transition Connectors [▶](#) on Page 68.

ONE-STEP BUTTON™ LOW PROFILE INITIAL PLACEMENT PEG KITS WITH ENFIT™†

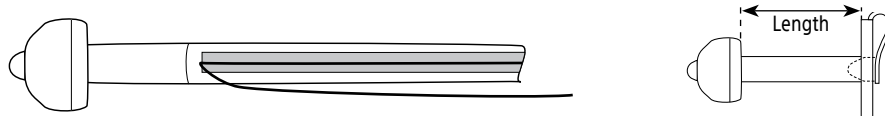

One-Step Button Low Profile PEG Kits with ENFit



Order Number	GTIN	Description	Length (cm)	Packaging
M00509690	08714729897415	18Fr Low Profile PEG Kit, Pull with ENFit	1.2	Each
M00509700	08714729897422	18Fr Low Profile PEG Kit, Pull with ENFit	1.7	Each
M00509710	08714729897439	18Fr Low Profile PEG Kit, Pull with ENFit	2.4	Each
M00509720	08714729897446	18Fr Low Profile PEG Kit, Pull with ENFit	3.4	Each
M00509730	08714729897453	18Fr Low Profile PEG Kit, Pull with ENFit	4.4	Each
M00509740	08714729897491	18Fr Low Profile PEG Kit, Push with ENFit	1.7	Each
M00509750	08714729897507	18Fr Low Profile PEG Kit, Push with ENFit	2.4	Each
M00509580	08714729897378	24Fr Low Profile PEG Kit, Pull with ENFit	1.7	Each
M00509590	08714729897385	24Fr Low Profile PEG Kit, Pull with ENFit	2.4	Each
M00509600	08714729897392	24Fr Low Profile PEG Kit, Pull with ENFit	3.4	Each
M00509610	08714729897408	24Fr Low Profile PEG Kit, Pull with ENFit	4.4	Each
M00509630	08714729897460	24Fr Low Profile PEG Kit, Push with ENFit	2.4	Each
M00509620	08714729897477	24Fr Low Profile PEG Kit, Push with ENFit	3.4	Each
M00509680	08714729897484	24Fr Low Profile PEG Kit, Push with ENFit	4.4	Each

One-Step Button and Low Profile Replacement Button Accessories with ENFit



Order Number	GTIN	Description	Length (cm)	Packaging
M00501121	08714729863380	18Fr Decompression Tube with ENFit	1.2	Box 10
M00501131	08714729863403	18Fr Decompression Tube with ENFit	1.7	Box 10
M00501141	08714729863427	18Fr Decompression Tube with ENFit	2.4	Box 10
M00501151	08714729863441	18Fr Decompression Tube with ENFit	3.4	Box 10
M00501161	08714729863465	18Fr Decompression Tube with ENFit	4.4	Box 10
M00501181	08714729863489	24Fr Decompression Tube with ENFit	1.7	Box 10
M00501191	08714729863502	24Fr Decompression Tube with ENFit	2.4	Box 10
M00501201	08714729863526	24Fr Decompression Tube with ENFit	3.4	Box 10
M00501211	08714729863540	24Fr Decompression Tube with ENFit	4.4	Box 10
M00501091	08714729863335	18Fr Bolus Feeding Set Straight Adapter with ENFit	-	Box 10
M00501061	08714729863281	18Fr Right Angle Feeding Set Continuous Adapter with ENFit	-	Box 10
M00501101	08714729863359	24Fr Bolus Feeding Set Straight Adapter with ENFit	-	Box 10
M00501071	08714729863304	24Fr Right Angle Feeding Set Continuous Adapter with ENFit	-	Box 10

*NOTE: Make sure all appropriate service lines in your healthcare system are ready to use ENFit enteral connectors. Please contact your Boston Scientific Sales Representative for support with ENFit enteral connectors.

Recommended ENFit Transition Connectors on Page 68.

REPLACEMENT GASTROSTOMY TUBES WITH ENFIT™†

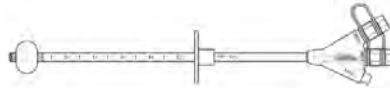

Replacement Gastrostomy Feeding Tube with ENFit, Straight Bolster



Order Number	GTIN	Description	Packaging
M00509881	00813939023862	12Fr Replacement G-Tube, Straight with ENFit	Box 5
M00509891	00813939023879	14Fr Replacement G-Tube, Straight with ENFit	Box 5
M00509901	00813939023886	16Fr Replacement G-Tube, Straight with ENFit	Box 5
M00509911	00813939023893	18Fr Replacement G-Tube, Straight with ENFit	Box 5
M00509921	00813939023909	20Fr Replacement G-Tube, Straight with ENFit	Box 5
M00509931	00813939023916	22Fr Replacement G-Tube, Straight with ENFit	Box 5
M00509941	00813939023923	24Fr Replacement G-Tube, Straight with ENFit	Box 5

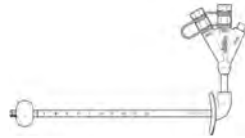

Replacement Gastrostomy Feeding Tube with ENFit, Right Angle Bolster



Order Number	GTIN	Description	Packaging
M00509961	00813939024005	12Fr Replacement G-Tube, Right Angle with ENFit	Box 5
M00509971	00813939024012	14Fr Replacement G-Tube, Right Angle with ENFit	Box 5
M00509981	00813939024029	16Fr Replacement G-Tube, Right Angle with ENFit	Box 5
M00509991	00813939024036	18Fr Replacement G-Tube, Right Angle with ENFit	Box 5
M00510001	00813939024043	20Fr Replacement G-Tube, Right Angle with ENFit	Box 5
M00510011	00813939024050	22Fr Replacement G-Tube, Right Angle with ENFit	Box 5
M00510021	00813939024067	24Fr Replacement G-Tube, Right Angle with ENFit	Box 5

LOW PROFILE REPLACEMENT BUTTONS & ACCESSORIES WITH ENFIT

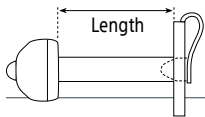

Low Profile Replacement Button with ENFit



Order Number	GTIN	Description	Length (cm)	Packaging
M00509830	08714729902614	18Fr Low Profile Replacement Button with ENFit	1.2	Each
M00509840	08714729902621	18Fr Low Profile Replacement Button with ENFit	1.7	Each
M00509850	08714729902638	18Fr Low Profile Replacement Button with ENFit	2.4	Each
M00509860	08714729902645	18Fr Low Profile Replacement Button with ENFit	3.4	Each
M00509870	08714729902652	18Fr Low Profile Replacement Button with ENFit	4.4	Each
M00509410	08714729902669	24Fr Low Profile Replacement Button with ENFit	1.7	Each
M00509420	08714729902676	24Fr Low Profile Replacement Button with ENFit	2.4	Each
M00509430	08714729902683	24Fr Low Profile Replacement Button with ENFit	3.4	Each
M00509440	08714729902690	24Fr Low Profile Replacement Button with ENFit	4.4	Each

*NOTE: Make sure all appropriate service lines in your healthcare system are ready to use ENFit enteral connectors. Please contact your Boston Scientific Sales Representative for support with ENFit enteral connectors.

Recommended ENFit Transition Connectors on Page 68.

▶ EndoVive™ Enteral Access Devices

LOW PROFILE REPLACEMENT BUTTON ACCESSORIES WITH ENFIT™†

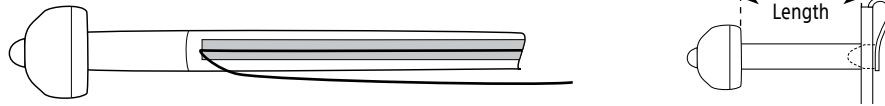

One-Step Button™ and Low Profile Replacement Button Accessories with ENFit



Order Number	GTIN	Description	Length (cm)	Packaging
M00501121	08714729863380	18Fr Decompression Tube with ENFit	1.2	Box 10
M00501131	08714729863403	18Fr Decompression Tube with ENFit	1.7	Box 10
M00501141	08714729863427	18Fr Decompression Tube with ENFit	2.4	Box 10
M00501151	08714729863441	18Fr Decompression Tube with ENFit	3.4	Box 10
M00501161	08714729863465	18Fr Decompression Tube with ENFit	4.4	Box 10
M00501181	08714729863489	24Fr Decompression Tube with ENFit	1.7	Box 10
M00501191	08714729863502	24Fr Decompression Tube with ENFit	2.4	Box 10
M00501201	08714729863526	24Fr Decompression Tube with ENFit	3.4	Box 10
M00501211	08714729863540	24Fr Decompression Tube with ENFit	4.4	Box 10
M00501091	08714729863335	18Fr Bolus Feeding Set Straight Adapter with ENFit	-	Box 10
M00501061	08714729863281	18Fr Right Angle Feeding Set Continuous Adapter with ENFit	-	Box 10
M00501101	08714729863359	24Fr Bolus Feeding Set Straight Adapter with ENFit	-	Box 10
M00501071	08714729863304	24Fr Right Angle Feeding Set Continuous Adapter with ENFit	-	Box 10

ENFit TRANSITION CONNECTORS

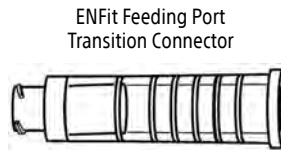

ENFit Transition Connectors



Order Number	GTIN	Description	Packaging
M00509241	10813939024972	ENFit Feeding Port Transition Connector	Box 10

*NOTE: Make sure all appropriate service lines in your healthcare system are ready to use ENFit enteral connectors. Please contact your Boston Scientific Sales Representative for support with ENFit enteral connectors.

▶ EndoVive™ Enteral Access Devices

INITIAL PLACEMENT PEG KITS

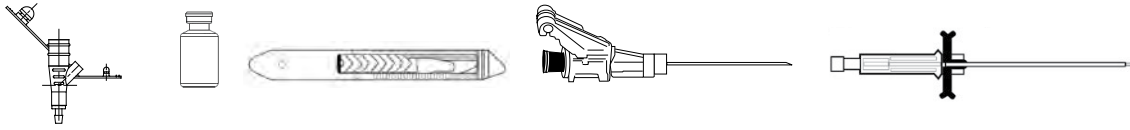

Safety PEG* Kit



Order Number	GTIN	Description	Packaging
M00566461	08714729802624	20Fr Safety PEG Kit, Pull	Box 2
M00566471	08714729802631	20Fr Safety PEG Kit, Push	Box 2
M00566481	08714729802648	24Fr Safety PEG Kit, Pull	Box 2
M00566491	08714729802655	24Fr Safety PEG Kit, Push	Box 2

*Includes local anesthetic.

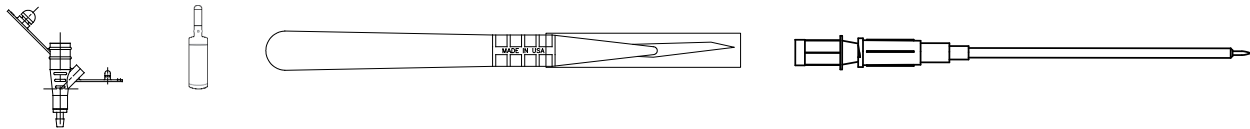

Standard PEG* Kit



Order Number	GTIN	Description	Packaging
M00568201	08714729285199	20Fr Standard PEG Kit, Pull	Box 2
M00568211	08714729285205	20Fr Standard PEG Kit, Push	Box 2
M00568241	08714729296799	24Fr Standard PEG Kit, Pull	Box 2
M00568251	08714729296805	24Fr Standard PEG Kit, Push	Box 2

*Includes local anesthetic.

Initial Placement PEG Accessories



Order Number	GTIN	Description	Packaging
M00580641	08714729169116	20Fr Y-Ports	Box 10
M00580651	08714729169123	24Fr Y-Ports	Box 10

INITIAL PLACEMENT LOW PROFILE PEG KITS

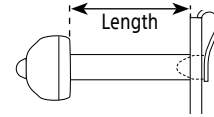
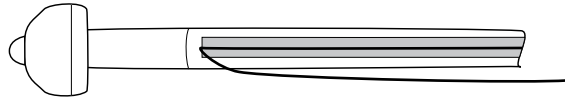

One-Step Button™ Low Profile PEG Kits 				
Order Number	GTIN	Description	Length (cm)	Packaging
M00563120	08714729284246	18Fr Low Profile PEG Kit, Pull	1.2	Each
M00563130	08714729284253	18Fr Low Profile PEG Kit, Pull	1.7	Each
M00563140	08714729284260	18Fr Low Profile PEG Kit, Pull	2.4	Each
M00563150	08714729284277	18Fr Low Profile PEG Kit, Pull	3.4	Each
M00563160	08714729284284	18Fr Low Profile PEG Kit, Pull	4.4	Each
M00563180	08714729284307	18Fr Low Profile PEG Kit, Push	1.7	Each
M00563190	08714729284314	18Fr Low Profile PEG Kit, Push	2.4	Each
M00563010	08714729284147	24Fr Low Profile PEG Kit, Pull	1.7	Each
M00563020	08714729284154	24Fr Low Profile PEG Kit, Pull	2.4	Each
M00563030	08714729284161	24Fr Low Profile PEG Kit, Pull	3.4	Each
M00563040	08714729268833	24Fr Low Profile PEG Kit, Pull	4.4	Each
M00563080	08714729284208	24Fr Low Profile PEG Kit, Push	2.4	Each
M00563090	08714729284215	24Fr Low Profile PEG Kit, Push	3.4	Each
M00563100	08714729284222	24Fr Low Profile PEG Kit, Push	4.4	Each

One-Step Button and Low Profile Replacement Button Accessories 				
Order Number	GTIN	Description	Length (cm)	Packaging
M00580401	08714729166443	18Fr Decompression Tube	1.2	Box 10
M00580411	08714729166450	18Fr Decompression Tube	1.7	Box 10
M00580421	08714729166467	18Fr Decompression Tube	2.4	Box 10
M00580431	08714729166474	18Fr Decompression Tube	3.4	Box 10
M00580441	08714729166481	18Fr Decompression Tube	4.4	Box 10
M00580461	08714729166504	24Fr Decompression Tube	1.7	Box 10
M00580471	08714729166511	24Fr Decompression Tube	2.4	Box 10
M00580481	08714729339649	24Fr Decompression Tube	3.4	Box 10
M00580491	08714729166535	24Fr Decompression Tube	4.4	Box 10
M00580171	08714729142232	18Fr Bolus Feeding Set Straight Adapter	-	Box 10
M00580181	08714729142249	18Fr Right Angle Feeding Set Continuous Adapter	-	Box 10
M00580231	08714729166405	24Fr Bolus Feeding Set Straight Adapter	-	Box 10
M00580241	08714729166412	24Fr Right Angle Feeding Set Continuous Adapter	-	Box 10

REPLACEMENT GASTROSTOMY TUBES

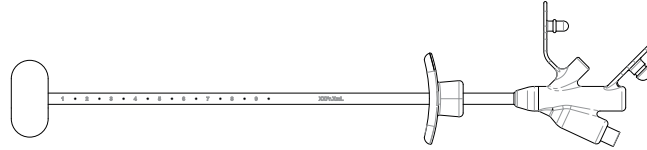

Replacement Gastrostomy Feeding Tubes, Straight Bolster



Order Number	GTIN	Description	Packaging
M00582040	00813939020243	12Fr Replacement G-Tube, Straight	Each
M00582050	00813939020250	14Fr Replacement G-Tube, Straight	Each
M00582060	00813939020267	16Fr Replacement G-Tube, Straight	Each
M00582070	00813939020274	18Fr Replacement G-Tube, Straight	Each
M00582080	00813939020281	20Fr Replacement G-Tube, Straight	Each
M00582860	00813939020298	22Fr Replacement G-Tube, Straight	Each
M00582090	00813939020304	24Fr Replacement G-Tube, Straight	Each
M00582100	00813939020311	28Fr Replacement G-Tube, Straight	Each

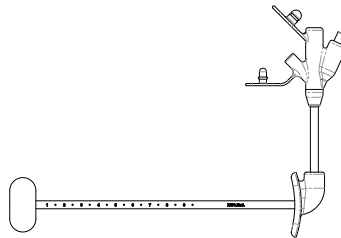

Replacement Gastrostomy Feeding Tubes, Right Angle Bolster



Order Number	GTIN	Description	Packaging
M00582110	00813939020007	12Fr Replacement G-Tube, Right Angle	Each
M00582120	00813939020014	14Fr Replacement G-Tube, Right Angle	Each
M00582130	00813939020021	16Fr Replacement G-Tube, Right Angle	Each
M00582140	00813939020038	18Fr Replacement G-Tube, Right Angle	Each
M00582150	00813939020045	20Fr Replacement G-Tube, Right Angle	Each
M00582870	00813939020052	22Fr Replacement G-Tube, Right Angle	Each
M00582160	00813939020069	24Fr Replacement G-Tube, Right Angle	Each
M00582170	00813939020076	28Fr Replacement G-Tube, Right Angle	Each

LOW PROFILE REPLACEMENT BUTTONS & ACCESSORIES

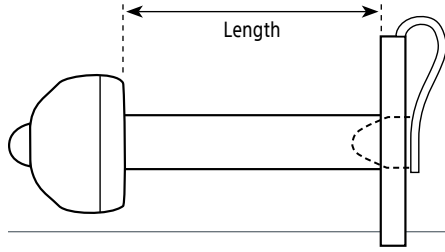

Low Profile Replacement Button



Order Number	GTIN	Description	Length (cm)	Packaging
M00562760	08714729284017	18Fr Low Profile Replacement Button	1.2	Each
M00562770	08714729142201	18Fr Low Profile Replacement Button	1.7	Each
M00562780	08714729284024	18Fr Low Profile Replacement Button	2.4	Each
M00562790	08714729284031	18Fr Low Profile Replacement Button	3.4	Each
M00562800	08714729284048	18Fr Low Profile Replacement Button	4.4	Each
M00562820	08714729284062	24Fr Low Profile Replacement Button	1.7	Each
M00562830	08714729142218	24Fr Low Profile Replacement Button	2.4	Each
M00562840	08714729284079	24Fr Low Profile Replacement Button	3.4	Each
M00562850	08714729284086	24Fr Low Profile Replacement Button	4.4	Each

One-Step Button™ and Low Profile Replacement Button Accessories



Order Number	GTIN	Description	Length (cm)	Packaging
M00580401	08714729166443	18Fr Decompression Tube	1.2	Box 10
M00580411	08714729166450	18Fr Decompression Tube	1.7	Box 10
M00580421	08714729166467	18Fr Decompression Tube	2.4	Box 10
M00580431	08714729166474	18Fr Decompression Tube	3.4	Box 10
M00580441	08714729166481	18Fr Decompression Tube	4.4	Box 10
M00580461	08714729166504	24Fr Decompression Tube	1.7	Box 10
M00580471	08714729166511	24Fr Decompression Tube	2.4	Box 10
M00580481	08714729339649	24Fr Decompression Tube	3.4	Box 10
M00580491	08714729166535	24Fr Decompression Tube	4.4	Box 10
M00580171	08714729142232	18Fr Bolus Feeding Set Straight Adapter	-	Box 10
M00580181	08714729142249	18Fr Right Angle Feeding Set Continuous Adapter	-	Box 10
M00580231	08714729166405	24Fr Bolus Feeding Set Straight Adapter	-	Box 10
M00580241	08714729166412	24Fr Right Angle Feeding Set Continuous Adapter	-	Box 10

JEJUNAL FEEDING TUBE DEVICES

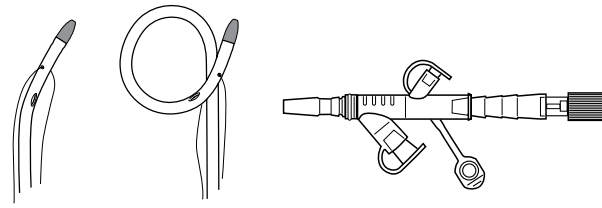

Through-The-PEG (TTP) Jejunal Feeding Tube ⓧ				
Order Number	GTIN	Description	Tip Style	Packaging
M00566320	08714729786313	8.5Fr TTP Jejunal Feeding Tube	Bent Tip	Each
M00566330	08714729789727	8.5Fr TTP Jejunal Feeding Tube	Pigtail Tip	Each
M00566340	08714729789666	12Fr TTP Jejunal Feeding Tube	Bent Tip	Each
M00566350	08714729786252	12Fr TTP Jejunal Feeding Tube	Pigtail Tip	Each

► Resection & Retrieval



Resection Devices

EMR for Upper GI

- ▶ Captivator™ EMR Device 78

Stiff Snares

- ▶ Captivator COLD Single-Use Snares 78
- ▶ Captivator II Single-Use Snares 79
- ▶ Captivator Single-Use Snares 79

Specialty Snares

- ▶ Profile™ Single-Use Snares 80
- ▶ Single-Use Rotatable Snares 80

Snares

- ▶ Captiflex™ Single-Use Snares 81
- ▶ Sensation™ Single-Use Short Throw Snares 81

Active Cords

- ▶ Active Cords 82

Electrosurgical Knife

- ▶ ORISE ProKnife 82

Retrieval Devices

Retrieval Device

- ▶ RescueNet™ Retrieval Device 83

Retrieval Grasping Forceps

- ▶ Rescue™ Rat Tooth Grasping Forceps 83
- ▶ Rescue Rat Tooth Grasping Forceps - Pediatric 83
- ▶ Rescue Alligator Grasping Forceps, Long 83
- ▶ Rescue Alligator Grasping Forceps 83
- ▶ Rescue Rat Tooth / Alligator Grasping Forceps 83

Polyp Traps

- ▶ TrapEase™ Single Chamber Polyp Trap 83
- ▶ TrapEase Quad Chamber Polyp Trap 83

► Resection Devices

EMR FOR UPPER GI

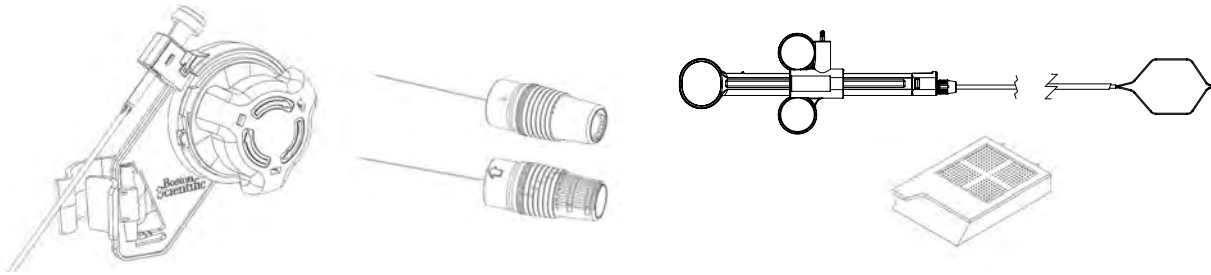

Captivator™ EMR Device



Order Number	GTIN	Description	Packaging
M00561600	08714729842675	Captivator EMR Device for Standard Gastroscopes	Box 1
M00561610	08714729842699	Captivator EMR Device for Large Gastroscopes	Box 1
M00561601	08714729842682	Captivator EMR Device for Standard Gastroscopes	Box 5
M00561611	08714729842705	Captivator EMR Device for Large Gastroscopes	Box 5

STIFF SNARES

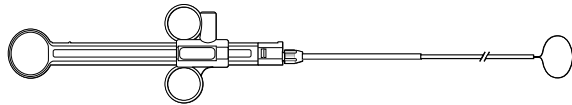

Captivator COLD Single-Use Snare



Order Number	GTIN	Description	Loop Width (mm)	Sheath O.D. (mm)	Minimum Working Channel (mm)	Working Length (cm)	Packaging
M00561101	08714729971269	10mm Rounded - Stiff	10	2.4	2.8	240	Box 10
M00561102	08714729984979	10mm Rounded - Stiff	10	2.4	2.8	240	Box 20
M00561103	08714729984986	10mm Rounded - Stiff	10	2.4	2.8	240	Box 40

Resection Devices

STIFF SNARES (Continued)

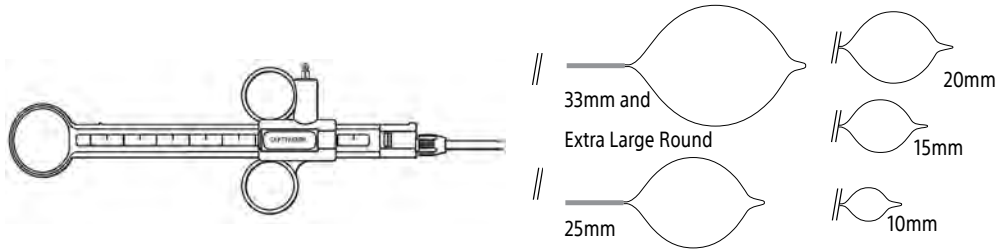

Captivator™ II Single-Use Snares



Order Number	GTIN	Description	Loop Width (mm)	Sheath O.D. (mm)	Minimum Working Channel (mm)	Working Length (cm)	Packaging
M00561221	08714729855903	10mm Rounded – Stiff	10	2.4	2.8	240	Box 10
M00561222	08714729861300	10mm Rounded – Stiff	10	2.4	2.8	240	Box 20
M00561223	08714729861317	10mm Rounded – Stiff	10	2.4	2.8	240	Box 40
M00561231	08714729855910	15mm Rounded – Stiff	15	2.4	2.8	240	Box 10
M00561232	08714729861331	15mm Rounded – Stiff	15	2.4	2.8	240	Box 20
M00561233	08714729861348	15mm Rounded – Stiff	15	2.4	2.8	240	Box 40
M00561241	08714729855927	20mm Rounded – Stiff	20	2.4	2.8	240	Box 10
M00561242	08714729861362	20mm Rounded – Stiff	20	2.4	2.8	240	Box 20
M00561243	08714729861379	20mm Rounded – Stiff	20	2.4	2.8	240	Box 40
M00561191	08714729855934	25mm Rounded – Stiff	25	2.4	2.8	240	Box 10
M00561192	08714729861270	25mm Rounded – Stiff	25	2.4	2.8	240	Box 20
M00561193	08714729861287	25mm Rounded – Stiff	25	2.4	2.8	240	Box 40
M00561291	08714729645801	Extra Large Rounded – Stiff	33	2.4	2.8	240	Box 10

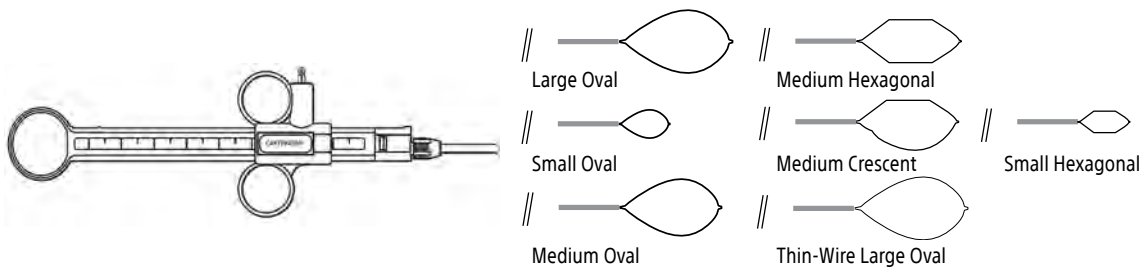

Captivator Single-Use Snares



Order Number	GTIN	Description	Loop Width (mm)	Sheath O.D. (mm)	Minimum Working Channel (mm)	Working Length (cm)	Packaging
M00562301	08714729019312	Small Oval – Stiff	13	2.4	2.8	240	Box 10
M00562321	08714729019336	Medium Oval – Stiff	27	2.4	2.8	240	Box 10
M00561311	08714729019251	Large Oval – Medium Stiff	30	2.4	2.8	240	Box 10
M00562391	08714729019404	Large Oval (thin wire) – Flexible	30	2.4	2.8	240	Box 10
M00562451	08714729071068	Small Hexagonal – Stiff	13	2.4	2.8	240	Box 10
M00562341	08714729019350	Medium Hexagonal – Stiff	27	2.4	2.8	240	Box 10
M00562371	08714729019381	Medium Crescent – Stiff	27	2.4	2.8	240	Box 10

► Resection Devices

SPECIALITY SNARES

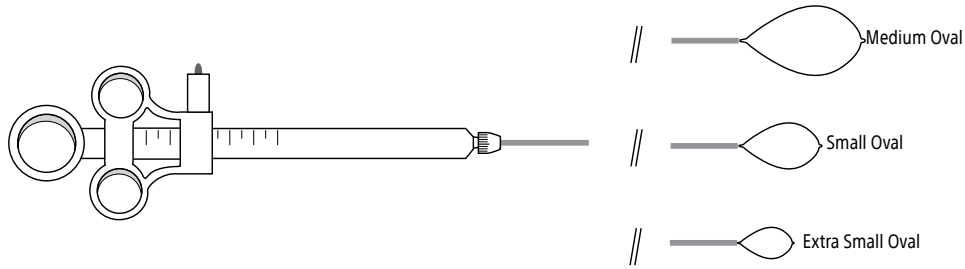

Profile™ Single-Use Snares



Order Number	GTIN	Description	Loop Width (mm)	Sheath O.D. (mm)	Minimum Working Channel (mm)	Working Length (cm)	Packaging
M00562531	08714729156628	Extra Small Oval - Flexible	11	1.9	2.0	240	Box 10
M00562551	08714729156659	Small Oval - Flexible	13	1.9	2.0	240	Box 10
M00562571	08714729156635	Medium Oval - Flexible	27	1.9	2.0	240	Box 10

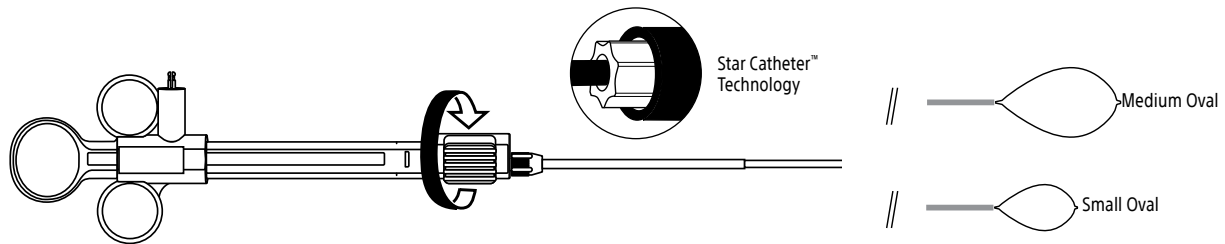

Single-Use Rotatable Snares*



Order Number	GTIN	Description	Loop Width (mm)	Sheath O.D. (mm)	Minimum Working Channel (mm)	Working Length (cm)	Packaging
M00561821	08714729283980	Small Oval - Medium Stiff	13	2.4	2.8	240	Box 10
M00561831	08714729283997	Medium Oval - Medium Stiff	20	2.4	2.8	240	Box 10

*With Star Catheter Technology.

Resection Devices

SNARES

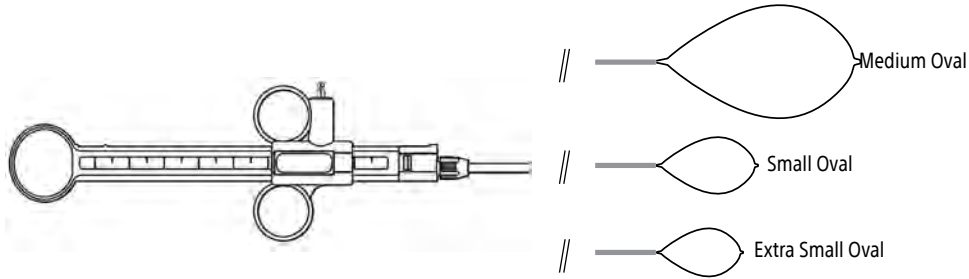

Captiflex™ Single-Use Snares



Order Number	GTIN	Description	Loop Width (mm)	Sheath O.D. (mm)	Minimum Working Channel (mm)	Working Length (cm)	Packaging
M00562471	08714729019459	Extra Small Oval – Flexible	11	2.4	2.8	240	Box 10
M00562421	08714729019435	Small Oval – Flexible	13	2.4	2.8	240	Box 10
M00562422	08714729501657	Small Oval – Flexible	13	2.4	2.8	240	Box 40
M00562401	08714729019411	Medium Oval – Flexible	27	2.4	2.8	240	Box 10
M00562402	08714729501640	Medium Oval – Flexible	27	2.4	2.8	240	Box 40

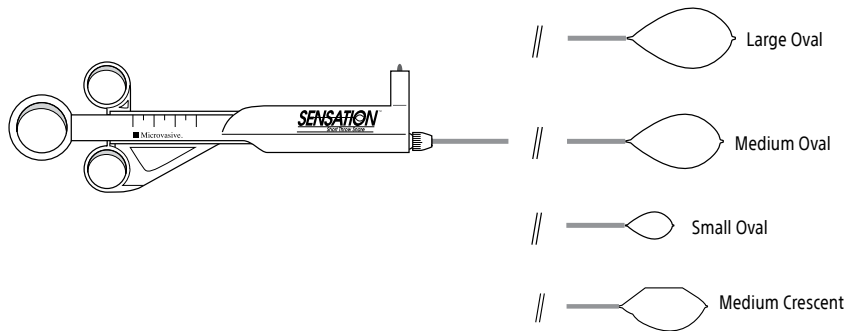

Sensation™ Single-Use Short Throw Snares



Order Number	GTIN	Description	Loop Width (mm)	Sheath O.D. (mm)	Minimum Working Channel (mm)	Working Length (cm)	Packaging
M00562691	08714729158158	Small Oval – Flexible	13	2.4	2.8	240	Box 5
M00562692	08714729268826	Small Oval – Flexible	13	2.4	2.8	240	Box 20
M00562693	08714729501671	Small Oval – Flexible	13	2.4	2.8	240	Box 40
M00560321	08714729283928	Small Oval – Medium Stiff	13	2.4	2.8	240	Box 5
M00562671	08714729158141	Medium Oval – Flexible	27	2.4	2.8	240	Box 5
M00562672	08714729268819	Medium Oval – Flexible	27	2.4	2.8	240	Box 20
M00562673	08714729501664	Medium Oval – Flexible	27	2.4	2.8	240	Box 40
M00560311	08714729283904	Medium Oval – Medium Stiff	27	2.4	2.8	240	Box 5
M00562651	08714729158110	Large Oval – Medium Stiff	30	2.4	2.8	240	Box 5
M00562652	08714729268802	Large Oval – Medium Stiff	30	2.4	2.8	240	Box 20
M00560331	08714729283935	Medium Crescent – Medium Stiff	27	2.4	2.8	240	Box 5

► Resection Devices

ACTIVE CORDS

Active Cords			
Order Number	GTIN	Description	Packaging
M00561250	08714729019060	Active Cord, Fits Olympus™ Brand Generator	Each
M00561270	08714729053361	Active Cord, Fits Endostat™, Endostat II and Endostat III Generators, Bovie™, Valleylab™, Aspen Labs™, and ERBE™ Brand Generators	Each

ELECTROSURGICAL KNIFE

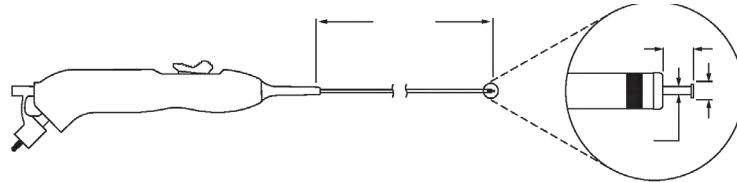

ORISE™ ProKnife						
Order Number	GTIN	Description	Catheter O.D. (mm)	Minimum Working Channel (mm)	Working Length (cm)	Packaging
M00519351	08714729999881	1.5mm ORISE ProKnife	2.21	2.8	230	Each
M00519361	08714729999898	2.0mm ORISE ProKnife	2.21	2.8	230	Each
M00519371	08714729999904	3.0mm ORISE ProKnife	2.21	2.8	230	Each

► Retrieval Devices

RETRIEVAL DEVICE

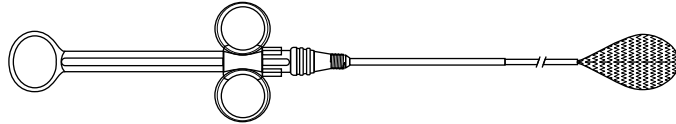

RescueNet™ Retrieval Device



Order Number	GTIN	Description	Net Size (mm)	Sheath O.D. (mm)	Minimum Working Channel (mm)	Working Length (cm)	Packaging
DGN-538-5	10840253107425	RescueNet Retrieval Device	30	2.5	2.8	230	Box 5

RETRIEVAL GRASPING FORCEPS

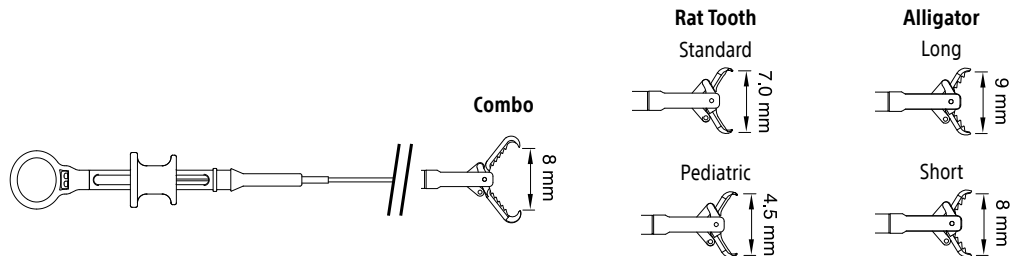

Rescue™ Retrieval Single-Use Grasping Forceps



Order Number	GTIN	Description	Jaw Opening Width (mm)	Sheath O.D. (mm)	Minimum Working Channel (mm)	Working Length (cm)	Packaging
M00527651	26948318968637	Rescue Rat Tooth Grasping Forceps	7	2.4	2.8	230	Box 5
M00527751	26948318968644	Rescue Rat Tooth Grasping Forceps - Pediatric	4.5	1.8	2.0	180	Box 5
M00527551	26948318968620	Rescue Alligator Grasping Forceps, Long	9	2.4	2.8	230	Box 5
M00527451	26948318968613	Rescue Alligator Grasping Forceps	8	2.4	2.8	230	Box 5
M00538351	26948318968606	Rescue Rat Tooth / Alligator Grasping Forceps	8	2.4	2.8	230	Box 5

POLYP TRAPS



TrapEase™ Polyp Traps

Order Number	GTIN	Description	Packaging
STE-297-50	00816849010182	TrapEase Single Chamber Polyp Trap	Box 50
STE-298-25	00816849010199	TrapEase Quad Chamber Polyp Trap	Box 25

▶ Infection Prevention



Infection Prevention

Cleaning Brushes

- ▶ HedgeHog™ Valve Brush 84
- ▶ HedgeHog Double Bundle..... 84
- ▶ HedgeHog Double-End Channel Brush 84
- ▶ HedgeHog Dual-End Channel / Valve Brush 84
- ▶ HedgeHog Sweeper Channel Brush 84
- ▶ HedgeHog Single-End Channel Brush..... 84

Detergent

- ▶ Pure™ Enzymatic Detergent - Spearmint Fresh Scent 84
- ▶ Pure Enzymatic Detergent - Fragrance Free..... 84

Bite Blocks

- ▶ Blox™ Endoscopic Bite Block with Elastic Cloth Strap (54 FR) ... 84
- ▶ Blox Endoscopic Bite Block with Elastic Cloth Strap (54 FR)
(w/o Dental Retention)..... 84
- ▶ Blox Endoscopic Bite Block with Elastic Cloth Strap (60 FR). 84

Lubricant

- ▶ Endoglide™ + Sterile Bacteriostatic Lubricating Gel 85
- ▶ Sterile Lubricating Jelly 85

Gowns

- ▶ EndoArmor™+ Surgical Gown, AAMI Level 3 85

Irrigation & Insufflation

- ▶ Hydra™ Disposable Auxiliary Water Jet Connector..... 85
- ▶ Hydra Water Bottle Cap..... 85
- ▶ Hydra Irrigation Tubing..... 85

Scope Transport

- ▶ CinchPad™ Endoscope Transport Pad..... 86

Sponges

- ▶ Koala™ Cleaning Sponge 86
- ▶ Koala Cleaning Sponge plus Pure Enzymatic 86

Suction Tubing

- ▶ Suction Tubing 86

Valves

- ▶ Orca™ Sterile Single-Use Air / Water & Suction Valves.....87
- ▶ OrcaPod™ 3 and 487
- ▶ Porpoise™ Air/Water Cleaning Adapter87
- ▶ Seal™ Single-Use Biopsy Valve87

Compliance EndoKit™

- ▶ Compliance EndoKit.....87

Aegis One-Hour Indicator

- ▶ Aegis One-Hour Indicator87

► Infection Prevention

CLEANING BRUSHES

HedgeHog™ Cleaning Brushes 						
Order Number	GTIN	Description	Catheter/Handle Length (cm)	Brush Length (mm)	Brush Width (mm)	Packaging
SBB-119-50	00816849010274	HedgeHog Valve Brush	6	40, 35	10, 5	Box 50
SBB-382-50	00816849016900	HedgeHog Double Bundle	240, 6	13, 40 / 35	5, 10 / 5	Box 50
SBD-228-50	00816849010083	HedgeHog Double-End Channel Brush	240	13	5	Box 50
SBD-289-50	00816849010090	HedgeHog Dual-End Channel / Valve Brush	45mm, 240	40, 13	10, 5	Box 50
SBD-291-50	00816849016443	HedgeHog Sweeper Channel Brush	240	13, 120	13, 5.5	Box 50
SBS-227-50	00816849010076	HedgeHog Single-End Channel Brush	240	13	5	Box 50

DETERGENT

Pure™ Enzymatic Detergents						
Order Number	GTIN	Description				Packaging
SEE-220-4	10840253105308	Pure Enzymatic Detergent - Spearmint Fresh Scent				Box 4
SEE-573-4	10840253105292	Pure Enzymatic Detergent - Fragrance Free				Box 4

BITE BLOCKS

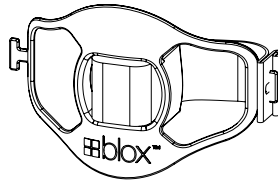

Blox™ Bite Blocks with Adjustable Straps 						
Order Number	GTIN	Description				Packaging
SBT-114-100	00816849010168	Blox Endoscopic Bite Block with Elastic Cloth Strap (54 FR)				Box 100
SBT-321-100	00816849016764	Blox Endoscopic Bite Block with Elastic Cloth Strap (54 FR) (w/o Dental Retention)				Box 100
SBT-546-100	00840253104809	Blox Endoscopic Bite Block with Elastic Cloth Strap (60 FR)				Box 100

► Infection Prevention

LUBRICANT

Endoglide™ +



Order Number	GTIN	Description	Packaging
SLT-394-100	00816849017167	Endoglide+ Sterile Bacteriostatic Lubricating Gel (32g / 1.1oz)	Box 100
SLT-395-50	00840253103055	Endoglide+ Sterile Bacteriostatic Lubricating Gel (56.7g / 2oz)	Box 50
SLT-612-50	20851809002900	Sterile Lubricating Jelly (56.7g / 2oz)	Box 50

GOWNS

EndoArmor™ Gown



Order Number	GTIN	Description	Packaging
M00501972	00191506005924	EndoArmor™+ Surgical Gown, AAMI Level 3	Box 100

IRRIGATION & INSUFFLATION

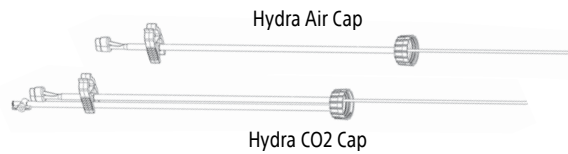

Hydra™ Irrigation System

Order Number	GTIN	Description	Scope Compatibility	CO2	Air/Water Tubing Length (in)	CO2 Tubing Length (in)	Packaging
SIT-361-100	00816849016955	Hydra Disposable Auxiliary Water Jet Connector	Olympus	N/A	N/A	N/A	Box 100
SCT-350-10	00816849016887	Hydra Water Bottle Cap System	Olympus	No	16	N/A	Box 10
SCT-351-10	00816849016894	Hydra Water Bottle Cap System	Olympus	Yes	16	18	Box 10
SIT-355-15	00840253112200	Hydra Irrigation Tubing System (compatible with ERBE, Medivators, and Olympus AUF-100 pumps)	N/A	N/A	N/A	N/A	Box 15
SIT-576-15	00840253108401	Hydra Irrigation Tubing System (compatible with Olympus pumps)	N/A	N/A	N/A	N/A	Box 15

SCOPE TRANSPORT

CinchPad™ Endoscope Transport Pad

Order Number	GTIN	Description	Packaging
SPX-017-25	00816849010045	CinchPad Endoscope Transport Pad (990.6mm x 1054mm)	Box 25

SPONGES



Koala™ Cleaning Sponges

Order Number	GTIN	Description	Packaging
SSB-210-50	00816849015613	Koala Cleaning Sponge	Box 50
SES-240-50	00816849015569	Koala Cleaning Sponge plus Pure Enzymatic	Box 50

SUCTION TUBING

Suction Tubing

Order Number	GTIN	Description	Packaging
SVT-089-100	00816849016788	Suction Tubing, NS, 3/16" x 6'	Box 100
SVT-090-100	00816849016795	Suction Tubing, NS, 3/16" x 10'	Box 100
SVT-095-100	00816849016801	Suction Tubing, NS, 3/16" x 12'	Box 100
SVT-143-100	00816849016818	Suction Tubing, NS, 1/4" X 6'	Box 100
SVT-144-60	00816849016825	Suction Tubing, NS 1/4" x 10'	Box 60
SVT-145-50	00816849016832	Suction Tubing, NS, 1/4" x 12'	Box 50

► Infection Prevention

VALVES

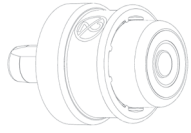

Orca™ Sterile Single-Use Air / Water & Suction Valves

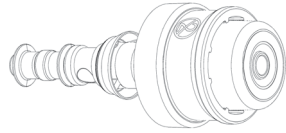

Porpoise™ Air/Water Cleaning Adapter

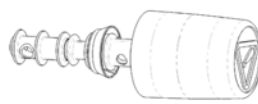

Seal™ Single-Use Biopsy Valve

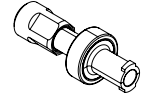

Hydra Disposable Auxiliary Water Jet Connector

Orca™ Sterile Single-Use Air / Water & Suction Valves



Order Number	GTIN	Description	Scope Compatibility	Packaging
SUV-617-50	00840253111012	Orca Sterile Single-Use Air / Water & Suction Valves	Olympus	Box 50

OrcaPod™



Order Number	GTIN	Description	Scope Compatibility	Packaging
SUV-628-50	08714729981565	OrcaPod 3 - Orca Sterile Single-Use Air/Water, Suction, and Seal Single-Use Biopsy Valve	Olympus	Box 50
SUV-629-50	08714729981589	OrcaPod 4 - Orca Sterile Single-Use Air/Water, Suction, and Seal Single-Use Biopsy Valve with WaterJet Connector	Olympus	Box 50

Porpoise™ Air/Water Cleaning Adapter



Order Number	GTIN	Description	Scope Compatibility	Packaging
M00501891	08714729896876	Porpoise™ Air/Water Cleaning Adapter (For use with Olympus 160, 180, and 190 gastrointestinal endoscopes)	Olympus	Box 50

Seal™ Single-Use Biopsy Valve



Order Number	GTIN	Description	Scope Compatibility	Packaging
SBC-501-100	08714729981602	Seal Single-Use Biopsy Valve	Olympus/Fuji	Box 100

COMPLIANCE ENDOKIT™

Compliance EndoKit



Order Number	GTIN	Description	Packaging
CEK-721-20	00840253113337	Compliance EndoKit Kit Components: CinchPad™ Endoscope Transport Pad, Gauze, EcoBowl, Koala™ Cleaning Sponge + Pure™ Enzymatic, Biohazard Label, HedgeHog™ DualEnd Channel/Valve Brush, Endoglide+ Sterile Bacteriostatic Lubricating Gel	Box 20

Please consult your Boston Scientific Territory Manager on options to customize your Compliance EndoKit™ to meet your individual endoscope reprocessing needs.

AEGIS ONE-HOUR INDICATOR

Aegis One-Hour Indicator



Order Number	GTIN	Description	Packaging
M00501991	191506007256	Aegis One-Hour Indicator	Box 100



Pulmonary Endoscopy

Scivita Single-Use Bronchoscope

- Scivita Single-Use Bronchoscope88

Airway Stents

- Ultraflex™ Single-Use Partially Covered Tracheobronchial Stent System – Distal Release89
- Ultraflex Single-Use Uncovered Tracheobronchial Stent System – Distal Release89
- Ultraflex Single-Use Uncovered Tracheobronchial Stent System – Proximal Release90

Biopsy Forceps

- Radial Jaw™ 4 Single-Use Pulmonary Biopsy Forceps 91

iNod™ Ultrasound Guidance System

- iNod™ Ultrasound Guidance System 91

Endobronchial Ultrasound (EBUS) Transbronchial Aspiration Needle

- Expect™ Pulmonary Endobronchial Ultrasound Transbronchial Aspiration Needle / Adaptor92

Endobronchial Ultrasound Fine Needle Biopsy (FNB) Device

- Acquire™ Pulmonary Fine Needle Biopsy Device92

Transbronchial Intra-Nodal Forceps Biopsy (IFB) Device

- CoreDx™ Pulmonary Mini Forceps92

Transbronchial Aspiration Needles

- eXcelon™ Transbronchial Aspiration Needle93

Cytology Brushes

- Cellebrity™ Single-Use Endoscopic Cytology Brush93

Airway Retrieval Baskets

- Zero Tip™ Airway Retrieval Basket.....93

Infection Prevention

- Compliance BronchKit.....93

Controlled Radial Expansion Pulmonary Balloon Dilatation Catheter

- CRE™ Pulmonary Balloon Dilatation Catheter94

Pulmonary Guidewires

- Amplatz Super Stiff™ Guidewire94
- Pulmonary Jagwire™ Pulmonary Guidewire94

Inflation System

- Alliance™ II Integrated Inflation / Lithotripsy Device94
- Alliance II Single-Use Syringe / Gauge Assembly94



SCIVITA SINGLE-USE BRONCHOSCOPE

Scivita Single-Use Bronchoscope 			
UPN	GTIN	Description	Packaging
SBV-1A-B	06971381254679	Single-use Broncho Videoscope, Distal End OD: 2.7mm, Insertion Tube OD: 2.8mm	Ea
SBV-1B-B	06971381254693	Single-use Broncho Videoscope, Distal End OD: 4.0mm, Insertion Tube OD: 4.2mm	Ea
SBV-1C-B	06971381254716	Single-use Broncho Videoscope, Distal End OD: 5.6mm, Insertion Tube OD: 5.6mm	Ea
BS-6060	06971381257141	Bronchus Sampler	Box 5
SC-60	06971381257585	Sample Container	Box 10
BRK-S01	06971381257564	Bracket	Ea
HDVS-S300D	06971381252422	Full HD Visualization Endoscopic Image Processor HDVS-S300D	Ea

AIRWAY STENTS

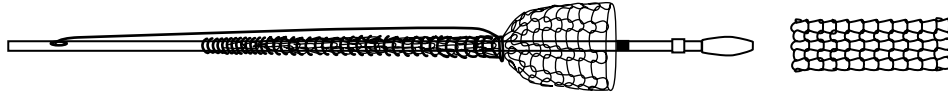

 Magnetic Resonance Conditional¹

Ultraflex™ Single-Use Uncovered Tracheobronchial Stent System – Distal Release*



Order Number	GTIN	Description	Expanded Stent O.D. (mm)	Expanded Stent Length (mm)	Compressed Stent Delivery System O.D. (mm)**	Tip Max O.D. (mm)	Packaging
M00576300	08714729837688	Uncovered Distal Release	10	30	7	4.1	Each
M00576310	08714729837695	Uncovered Distal Release	12	30	7	4.1	Each
M00576320	08714729837701	Uncovered Distal Release	14	30	9	4.1	Each
M00576330	08714729837718	Uncovered Distal Release	16	40	9	5.3	Each
M00576340	08714729837725	Uncovered Distal Release	16	60	9	5.3	Each
M00576350	08714729837732	Uncovered Distal Release	18	40	11	5.3	Each
M00576360	08714729837749	Uncovered Distal Release	18	60	11	5.3	Each
M00576370	08714729837756	Uncovered Distal Release	20	40	11	5.3	Each
M00576380	08714729837763	Uncovered Distal Release	20	60	11	5.3	Each

*Recommended Guidewire .035" Pulmonary Jagwire™ Pulmonary Guidewire Order #1517 and Amplatz Super Stiff™ Guidewire, Order #5009,  (See page 90).
Delivery System working length is 95cm.

**Data on File at Boston Scientific.

¹Product with this symbol may be used in Magnetic Resonance environment according to the conditions described in Directions for Use.



 Magnetic Resonance Conditional¹

Ultraflex Single-Use Uncovered Tracheobronchial Stent System – Proximal Release*



Order Number	GTIN	Description	Expanded Stent O.D. (mm)	Expanded Stent Length (mm)	Compressed Stent Delivery System O.D. (mm)**	Tip Max O.D. (mm)	Packaging
M00576410	08714729837770	Uncovered Proximal Release	8	20	7	4.1	Each
M00576420	08714729837787	Uncovered Proximal Release	8	40	7	4.1	Each
M00576430	08714729837794	Uncovered Proximal Release	10	20	7	4.1	Each
M00576440	08714729837800	Uncovered Proximal Release	10	40	7	4.1	Each
M00576450	08714729837817	Uncovered Proximal Release	12	20	7	4.1	Each
M00576460	08714729837824	Uncovered Proximal Release	12	40	7	4.1	Each
M00576470	08714729837831	Uncovered Proximal Release	14	20	9	4.1	Each
M00576480	08714729837848	Uncovered Proximal Release	14	40	9	4.1	Each
M00576490	08714729837855	Uncovered Proximal Release	14	60	9	4.1	Each

*Recommended Guidewire .035" Pulmonary Jagwire™ Pulmonary Guidewire Order #1517 and Amplatz Super Stiff™ Guidewire, Order #5009,  (See page 90).
Delivery System working length is 95cm.

**Data on File at Boston Scientific.

¹Product with this symbol may be used in Magnetic Resonance environment according to the conditions described in Directions for Use.

AIRWAY STENTS (Continued)

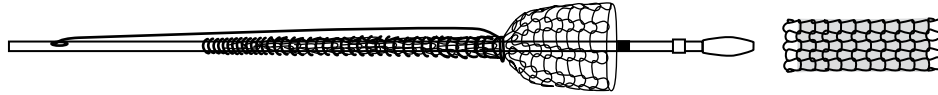

 Magnetic Resonance Conditional

Ultraflex™ Single-Use Partially Covered Tracheobronchial Stent System – Distal Release*



Order Number	GTIN	Description	Expanded Stent O.D. (mm)	Expanded Stent Length (mm)	Compressed Stent Delivery System O.D. (mm)**	Cover Length (mm)	Tip Max O.D. (mm)	Packaging
M00576520	08714729842323	Partially Covered Distal Release	8	40	7	25	4.1	Each
M00576530	08714729842330	Partially Covered Distal Release	10	30	7	15	4.1	Each
M00576540	08714729842347	Partially Covered Distal Release	10	40	7	25	4.1	Each
M00576550	08714729842354	Partially Covered Distal Release	12	30	7	15	4.1	Each
M00576560	08714729842361	Partially Covered Distal Release	12	40	7	25	4.1	Each
M00576570	08714729842378	Partially Covered Distal Release	14	30	9	15	4.1	Each
M00576580	08714729842385	Partially Covered Distal Release	14	40	9	25	4.1	Each
M00576590	08714729842392	Partially Covered Distal Release	14	60	9	45	4.1	Each
M00576600	08714729842408	Partially Covered Distal Release	14	80	9	65	4.1	Each
M00576610	08714729842415	Partially Covered Distal Release	16	40	9	25	5.3	Each
M00576620	08714729842422	Partially Covered Distal Release	16	60	9	45	5.3	Each
M00576630	08714729842439	Partially Covered Distal Release	16	80	9	65	5.3	Each
M00576640	08714729842446	Partially Covered Distal Release	18	40	11	25	5.3	Each
M00576650	08714729842453	Partially Covered Distal Release	18	60	11	45	5.3	Each
M00576660	08714729842460	Partially Covered Distal Release	18	80	11	65	5.3	Each
M00576670	08714729842477	Partially Covered Distal Release	20	40	11	25	5.3	Each
M00576680	08714729842484	Partially Covered Distal Release	20	60	11	45	5.3	Each
M00576690	08714729842491	Partially Covered Distal Release	20	80	11	65	5.3	Each

*Recommended Guidewire .035" Pulmonary Jagwire™ Pulmonary Guidewire Order #1517 and Amplatz Super Stiff™ Guidewire, Order #5009,  (See page 94). Delivery System working length is 95cm.

**Data on File at Boston Scientific.

¹Product with this symbol may be used in Magnetic Resonance environment according to the conditions described in Directions for Use.

► Pulmonary

BIOPSY FORCEPS

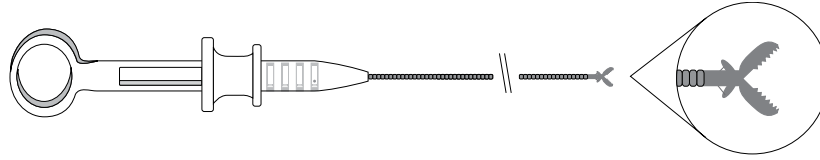

Radial Jaw™ 4 Single-Use Pulmonary Biopsy Forceps



Order Number	GTIN	Description	Differentiator	Jaw O.D. (mm)	Working Length (cm)	Minimum Working Channel (mm)	Packaging
M00515181	08714729792864	Single-Use Biopsy Forceps	Pulmonary Standard Capacity	1.8	100	2.0	Box 5
M00515182	08714729799337	Single-Use Biopsy Forceps	Pulmonary Standard Capacity	1.8	100	2.0	Box 20
M00515191	08714729792871	Single-Use Biopsy Forceps	Pulmonary Standard Capacity w/ Needle	1.8	100	2.0	Box 5
M00515192	08714729818083	Single-Use Biopsy Forceps	Pulmonary Standard Capacity w/ Needle	1.8	100	2.0	Box 20
M00515201	08714729793281	Single-Use Biopsy Forceps	Pulmonary Large Capacity	2.2	100	2.8	Box 5
M00515202	08714729818076	Single-Use Biopsy Forceps	Pulmonary Large Capacity	2.2	100	2.8	Box 20

INOD™ ULTRASOUND GUIDANCE SYSTEM

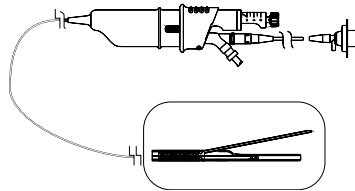

iNod™ Ultrasound Guidance System



Order Number	GTIN	Description	Packaging
M00502060	00191506020729	iNod™ Ultrasound Guided Biopsy Needle	Box 1
M00503210	00191506020910	iNod™ Ultrasound Guidance Console	Box 1

► Pulmonary

EXPECT™ PULMONARY ENDOBRONCHIAL ULTRASOUND TRANSBRONCHIAL ASPIRATION NEEDLE

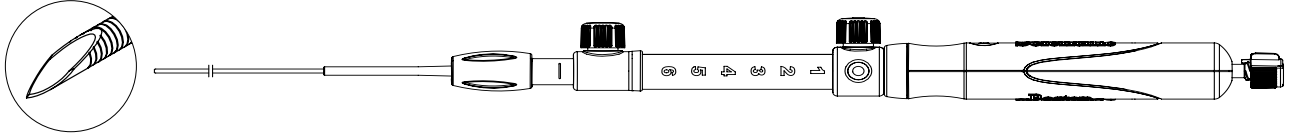

Expect Pulmonary Endobronchial Ultrasound Transbronchial Aspiration Needle



Order Number	GTIN	Needle Size	Minimum Working Channel (mm)	Sheath O.D. (mm)	Packaging
M00558220	08714729861409	22Ga - Olympus scope compatible	2.0	1.6	Each
M00558250	08714729861416	25Ga - Olympus scope compatible	2.0	1.4	Each
M00558731	08714729893189	Expect Pulmonary Needle Adaptor - Olympus scope compatible	N/A	N/A	Box 10

ACQUIRE™ PULMONARY ENDOBRONCHIAL ULTRASOUND FINE NEEDLE BIOPSY DEVICE

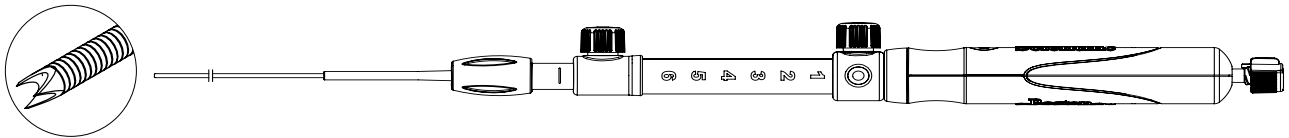

Acquire Pulmonary Endobronchial Ultrasound Fine Needle Biopsy Device



Order Number	GTIN	Needle Size	Minimum Working Channel (mm)	Sheath O.D. (mm)	Packaging
M00552350	08714729986225	22Ga - Olympus Scope Compatible	2.0	1.6	Each
M00552400	08714729986249	25Ga - Olympus Scope Compatible	2.0	1.4	Each
M00558731	08714729893189	Expect Pulmonary Needle Adaptor - Olympus scope compatible	N/A	N/A	Box 10

COREDx™ PULMONARY MINI-FORCEPS FOR ENDOBRONCHIAL ULTRASOUND

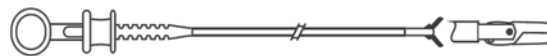

CoreDx Pulmonary Mini-Forceps for Endobronchial Ultrasound



Order Number	GTIN	Description	Minimum Working Channel (mm)	Catheter Length (cm)	Packaging
M00515220	08714729971054	CoreDx Pulmonary Mini-Forceps	1.2	130	Each

Pulmonary

TRANSBRONCHIAL ASPIRATION NEEDLES

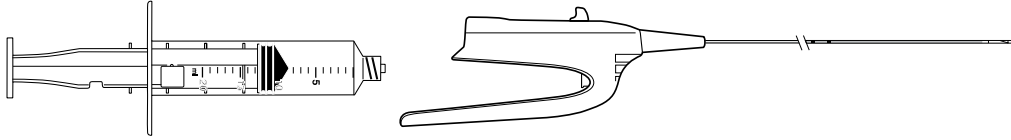

eXcelon™ Transbronchial Aspiration Needle*



Order Number	GTIN	Description	Needle Gauge	Needle Length (mm)	Catheter Length (cm)	Sheath O.D. (mm)	Packaging
M00564101	08714729456452	eXcelon Transbronchial Aspiration Needle	19	15	130	1.8	Box 5
M00564111	08714729456469	eXcelon Transbronchial Aspiration Needle	20	15	130	1.8	Box 5
M00564121	08714729456476	eXcelon Transbronchial Aspiration Needle	21	15	130	1.8	Box 5

*Packaging also includes a 20ml syringe.

CYTOLOGY BRUSHES

Celebrity™ Single-Use Endoscopic Cytology Brush



Order Number	GTIN	Required Working Channel (mm)	Bristle O.D. (mm)	Sheath Length (cm)	Packaging
M00516001	08714729138983	2.0	1.0	140	Box 10
M00516011	08714729138990	2.0	1.5	140	Box 10
M00516071	08714729139089	2.0	1.9	100	Box 10
M00516151	08714729014003	2.0	1.9	150	Box 10

AIRWAY RETRIEVAL BASKETS

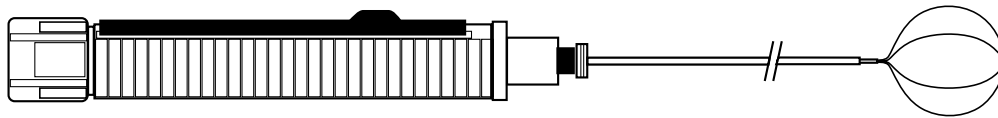

Zero Tip™ Airway Retrieval Basket



Order Number	GTIN	Description	Sheath O.D. (mm)	Working Length (cm)	Basket Opening (mm)	Packaging
M00513200	08714729414995	Zero Tip Airway Retrieval Basket	0.8	120	12	Each
M00513210	08714729415008	Zero Tip Airway Retrieval Basket	1.0	120	16	Each

INFECTION PREVENTION

Compliance BronchKit

Order Number	GTIN	Description	Packaging
CBK-881-20	00840253116031	Compliance BronchKit Kit Components: CinchPad™ Endoscope Transport Pad, Gauze, EcoBowl, Koala Cleaning Sponge + Pure Enzymatic, Biohazard Label, HedgeHog™ Double Bundle Cleaning Brush, 20ml Syringe	Box 20
CBK-882-20	00840253120281	Compliance BronchKit Kit Components: CinchPad™ Endoscope Transport Pad, Gauze, EcoBowl, Koala Cleaning Sponge + Pure Enzymatic, Biohazard Label, HedgeHog™ Double Bundle Cleaning Brush, 20ml Syringe, EndoArmor+ Gown, Suction Tubing	Box 20

CONTROLLED RADIAL EXPANSION PULMONARY BALLOON DILATATION CATHETER



CRE™ Pulmonary Balloon Dilatation Catheter*



Order Number	GTIN	Balloon Inflated O.D.		Balloon Length (cm)	Inflation Pressures		Catheter Length (cm)	Packaging
		(mm)	(Fr)		(atm)	(kPa)		
M00550300	08714729456186	12-13.5-15	36-40.5-45	5.5	3-4.5-8	304-456-811	110	Each
M00550310	08714729456193	15-16.5-18	45-49.5-54	5.5	3-4.5-7	304-456-709	110	Each
M00550320	08714729456209	18-19-20	54-57-60	5.5	3-4.5-6	304-456-608	110	Each
M00550330	08714729456216	8-9-10	24-27-30	3.0	3-5.5-9	304-557-912	110	Each
M00550340	08714729456223	10-11-12	30-33-36	3.0	3-5-8	304-507-811	110	Each
M00550350	08714729456230	12-13.5-15	36-40.5-45	3.0	3-4.5-8	304-456-811	110	Each

*Recommended Inflation Device: Alliance™ II Integrated Inflation / Lithotripsy Device Order #5062, Alliance II Single-Use Syringe / Gauge Assembly Order #5060 (see below).

PULMONARY GUIDEWIRES

Pulmonary Jagwire™ Pulmonary Guidewire



Order Number	GTIN	Description	O.D. (in)	Length (cm)	Packaging
M00515171	08714729455813	Pulmonary Jagwire Pulmonary Guidewire	.035	180	Box 2

Amplatz Super Stiff™ Guidewire



Order Number	GTIN	Description	O.D. (in)	Length (cm)	Packaging
M00550090	08714729301929	Amplatz Super Stiff Guidewire	.038	260	Each

INFLATION SYSTEM

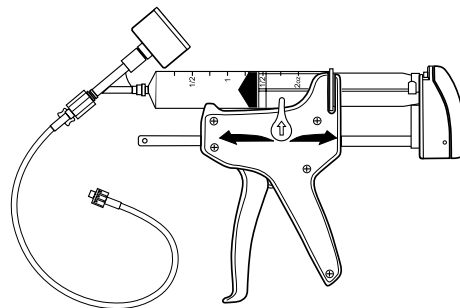

Alliance™ II Integrated Inflation / Lithotripsy Device and Alliance II Single-Use Syringe / Gauge Assembly

Order Number	GTIN	Description	Packaging
M00550620	08714729283881	Alliance II Integrated Inflation / Lithotripsy Device	Each
M00550601	08714729129332	 Alliance II Single-Use Syringe / Gauge Assembly	Box 5



Solutions

► GuidePoint Reimbursement Resources and Solutions	95
► ADVANTICS™ Innovative Healthcare Solutions	96
► GI Specialized Pathology	96
► Scope Repair	96
► GI Lab Optimization	96

GUIDEPOINT REIMBURSEMENT RESOURCES AND SOLUTIONS

The Endoscopy Health Economics and Market Access (HEMA) Team offers a suite of reimbursement services and support for healthcare professionals seeking a better understanding of reimbursement for Boston Scientific's endoscopy and pulmonary products and procedures. We can help you develop a base level of knowledge in coding, coverage and payment for these procedures and offer educational presentations and webinars on changes in healthcare policies and Medicare reimbursement and changes to Medicare reimbursement impacting providers and facilities.

About Our Team

Boston Scientific Endoscopy's HEMA Team is comprised of highly skilled professionals specializing in reimbursement, health economics and health policy issues. The team has a broad background with experience working for public and private payers, medical associations, healthcare consulting agencies and academic research organizations. We use clinical and economic outcomes data and collaborate with outside experts to promote appropriate coding, coverage and reimbursement for Boston Scientific endoscopy and pulmonary products and procedures.

Contact Information

For more information about Boston Scientific Endoscopy's GuidePoint Reimbursement Resources and Solutions, please contact our **Health Economics and Reimbursement department at 800-876-9960 x54510 or ENDOREIMBURSEMENT@bsci.com**.

www.bostonscientific.com/reimbursement



Health economic and reimbursement information provided by Boston Scientific Corporation is gathered from third-party sources and is subject to change without notice as a result of complex and frequently changing laws, regulations, rules and policies. This information is presented for illustrative purposes only and does not constitute reimbursement or legal advice. Boston Scientific encourages providers to submit accurate and appropriate claims for services. It is always the provider's responsibility to determine medical necessity, the proper site for delivery of any services and to submit appropriate codes, charges, and modifiers for services that are rendered. Boston Scientific recommends that you consult with your payers, reimbursement specialists and/or legal counsel regarding coding, coverage and reimbursement matters. Boston Scientific does not promote the use of its products outside their FDA-approved label.

► Solutions

Boston Scientific's Endoscopy business develops less invasive medical devices for treating gastrointestinal diseases. We are committed to providing clinically proven technologies, services and customer support to help healthcare providers improve patient outcomes while reducing the total cost of patient care.

ADVANTICS™ INNOVATIVE HEALTHCARE SOLUTIONS

ADVANTICS™ Innovative Healthcare Solutions is a new way to collaborate to meet your specific challenges in the changing healthcare landscape. ADVANTICS recognizes that every provider is unique and that only by working together can we find truly effective solutions.



GI SPECIALIZED PATHOLOGY

Diagnostics for GI Diseases. Getting an accurate and timely diagnosis is critical to patient care. GI Specialized Pathology services include GI subspecialty trained pathologists, GI trained histotechnicians to help ensure proper slide orientation, and customer service teams dedicated to improving efficiencies and the diagnosis process for physicians and their patients. Today, of the top diagnostic labs in the U.S., ours is the only pathology lab focused solely on GI diseases.



SCOPE REPAIR

Capital Equipment Management. As an alternative to original equipment manufacturer (OEM) and costly service contracts, scope repair services and certified pre-owned equipment are offered through a partnership with Total Scope, Inc. Established in 1993, Total Scope is focused on providing excellent customer service, including scope maintenance education and training for its customers. The company is certified to the quality standard ISO 13485, for the service, repair and maintenance of medical instrumentation. Total Scope is a woman-owned business.

GI LAB OPTIMIZATION

Endoscopy Lab and Continuous Improvement. GI Lab Optimization services are designed to address specific customer issues related to quality, cost, safety, and staff and patient satisfaction. A mix of Lean Six Sigma, project management and Human Centered Design expertise can be used to tailor solutions to your needs for endoscopy lab optimization.

To learn more visit, [bostonscientific.com/endoscopiesolutions](https://www.bostonscientific.com/endoscopiesolutions)

▶ Product Code Index



Product Code Index

▶ Begins on Page	97
------------------------	----

Product Code Index

Product Code	Description	Page #	Product Code	Description	Page #
5100	Biopolar Adaptor Cable, 28mm spacing	31	M00502060	iNod™ Ultrasound Guided Biopsy Needle	91
5420	Biopolar Adaptor Cable, 4mm Pin*	31	M00503210	iNod™ Ultrasound Guidance Console	91
5700	Biopolar Adaptor Cable, 22mm spacing	31	M00505410	OverStitch™ Endoscopic Suture System	57
B-4800	Orbera™ IntraGastric Balloon System	56	M00505430	OverStitch NXT™ NeXT Generation Single Channel Endoscopic System	57
B-4815	IntraGastric Balloon Removal Kit	56	M00505451	OverStitch 2-0 Polypropylene Suture	58
CBK-881-20	Compliance BronchKit	93	M00505460	OverStitch Tissue Helix	59
CBK-882-20	Compliance BronchKit	93	M00505490	OverStitch NXT™ Tissue Helix Pro	59
CEK-721-20	Compliance EndoKit™	87	M00505530	OverStitch Suture Cinch	58
DGA-275-5	Rescue™ Alligator Long Grasping Forceps	83	M00505560	OverTube™ Endoscopic Access System	60
DGN-538-5	RescueNet™ Retrieval Device	83	M00509001	EndoVive Safety PEG Kit, Pull with ENFit	69
DGR-276-5	Rescue Rat Tooth Grasping Forceps	83	M00509011	EndoVive Safety PEG Kit, Push with ENFit	69
ES26165-3	Ensizor Endoscopic Scissors (Gastric Length)	60	M00509021	EndoVive Safety PEG Kit, Pull with ENFit	69
ES26235-3	Ensizor Endoscopic Scissors (Colonic Length)	60	M00509031	EndoVive Safety PEG Kit, Push with ENFit	69
H965180010	WALLSTENT™ Super Stiff Guidewire	3	M00509041	EndoVive Standard PEG Kit, Pull with ENFit	69
M00500070	Habib™ EndoHPB Biopolar RF Catheter	31	M00509051	EndoVive Standard PEG Kit, Push with ENFit	69
M00501061	EndoVive™ Low Profile Replacement Button Accessories with ENFit™ – 18Fr Right Angle Feeding Set, Continuous Adapter	72	M00509061	EndoVive Standard PEG Kit, Pull with ENFit	69
M00501071	EndoVive Low Profile Replacement Button Accessories with ENFit – 24Fr Right Angle Feeding Set, Continuous Adapter	72	M00509071	EndoVive Standard PEG Kit, Push with ENFit	69
M00501091	EndoVive Low Profile Replacement Button Accessories with ENFit – 18Fr Bolus Feeding Set, Straight Adapter	72	M00509241	ENFit Feeding Port Transition Connector	72
M00501101	EndoVive Low Profile Replacement Button Accessories with ENFit – 24Fr Bolus Feeding Set, Straight Adapter	72	M00509580	EndoVive One-Step Button™ Low Profile PEG Kit, Pull with ENFit	70
M00501121	EndoVive Low Profile Replacement Button Accessories with ENFit – 18Fr Decompression Tube	72	M00509590	EndoVive One-Step Button Low Profile PEG Kit, Pull with ENFit	70
M00501131	EndoVive Low Profile Replacement Button Accessories with ENFit – 18Fr Decompression Tube	72	M00509600	EndoVive One-Step Button Low Profile PEG Kit, Pull with ENFit	70
M00501141	EndoVive Low Profile Replacement Button Accessories with ENFit – 18Fr Decompression Tube	72	M00509610	EndoVive One-Step Button Low Profile PEG Kit, Pull with ENFit	70
M00501151	EndoVive Low Profile Replacement Button Accessories with ENFit – 18Fr Decompression Tube	72	M00509620	EndoVive One-Step Button Low Profile PEG Kit, Push with ENFit	70
M00501161	EndoVive Low Profile Replacement Button Accessories with ENFit – 18Fr Decompression Tube	72	M00509630	EndoVive One-Step Button Low Profile PEG Kit, Push with ENFit	70
M00501181	EndoVive Low Profile Replacement Button Accessories with ENFit – 24Fr Decompression Tube	72	M00509680	EndoVive One-Step Button Low Profile PEG Kit, Push with ENFit	70
M00501191	EndoVive Low Profile Replacement Button Accessories with ENFit – 24Fr Decompression Tube	72	M00509690	EndoVive One-Step Button Low Profile PEG Kit, Pull with ENFit	70
M00501201	EndoVive Low Profile Replacement Button Accessories with ENFit – 24Fr Decompression Tube	72	M00509700	EndoVive One-Step Button Low Profile PEG Kit, Pull with ENFit	70
M00501211	EndoVive Low Profile Replacement Button Accessories with ENFit – 24Fr Decompression Tube	72	M00509710	EndoVive One-Step Button Low Profile PEG Kit, Pull with ENFit	70
M00501261	EndoVive Initial Placement PEG Accessories – Y-Ports with ENFit	69	M00509720	EndoVive One-Step Button Low Profile PEG Kit, Pull with ENFit	70
M00501271	EndoVive Initial Placement PEG Accessories – Y-Ports with ENFit	69	M00509730	EndoVive One-Step Button Low Profile PEG Kit, Pull with ENFit	70
M00501891	Porpoise™ Air/Water Cleaning Adapter	87	M00509740	EndoVive One-Step Button Low Profile PEG Kit, Push with ENFit	70
M00501972	EndoArmor™+ Surgical Gown, AAMI Level 3	85	M00509750	EndoVive One-Step Button Low Profile PEG Kit, Push with ENFit	70
M00501991	Aegis One-Hour Indicator	87	M00509830	EndoVive Low Profile Replacement Button with ENFit	71
			M00509840	EndoVive Low Profile Replacement Button with ENFit	71

*For use with the Habib EndoHPB Bipolar Radiofrequency Catheter

Product Code Index

Product Code	Description	Page #	Product Code	Description	Page #
M00509850	EndoVive Low Profile Replacement Button with ENFit	71	M00513323	Radial Jaw 4 Single-Use Large Capacity Biopsy Forceps	67
M00509860	EndoVive™ Low Profile Replacement Button with ENFit™	71	M00513331	Radial Jaw 4 Single-Use Large Capacity Biopsy Forceps w/ Needle	67
M00509870	EndoVive Low Profile Replacement Button with ENFit	71	M00513332	Radial Jaw 4 Single-Use Large Capacity Biopsy Forceps w/ Needle	67
M00509410	EndoVive™ Low Profile Replacement Button with ENFit™	71	M00513333	Radial Jaw 4 Single-Use Large Capacity Biopsy Forceps w/ Needle	67
M00509420	EndoVive Low Profile Replacement Button with ENFit	71	M00513343	Radial Jaw 4 Single-Use Jumbo Biopsy Forceps	67
M00509430	EndoVive Low Profile Replacement Button with ENFit	71	M00513353	Radial Jaw 4 Single-Use Jumbo Biopsy Forceps w/ Needle	67
M00509440	EndoVive Low Profile Replacement Button with ENFit	71	M00513361	Radial Jaw 4 Single-Use Jumbo Biopsy Forceps	67
M00509881	EndoVive Replacement Gastrostomy Feeding Tube, with ENFit, Straight	71	M00513362	Radial Jaw 4 Single-Use Jumbo Biopsy Forceps	67
M00509891	EndoVive Replacement Gastrostomy Feeding Tube, with ENFit, Straight	71	M00513363	Radial Jaw 4 Single-Use Jumbo Biopsy Forceps	67
M00509901	EndoVive Replacement Gastrostomy Feeding Tube, with ENFit, Straight	71	M00513371	Radial Jaw 4 Single-Use Jumbo Biopsy Forceps w/ Needle	67
M00509911	EndoVive Replacement Gastrostomy Feeding Tube, with ENFit, Straight	71	M00513372	Radial Jaw 4 Single-Use Jumbo Biopsy Forceps w/ Needle	67
M00509921	EndoVive Replacement Gastrostomy Feeding Tube, with ENFit, Straight	71	M00513373	Radial Jaw 4 Single-Use Jumbo Biopsy Forceps w/ Needle	67
M00509931	EndoVive Replacement Gastrostomy Feeding Tube, with ENFit, Straight	71	M00513381	Radial Jaw 4 Standard Capacity Single-Use Biopsy Forceps	67
M00509941	EndoVive Replacement Gastrostomy Feeding Tube, with ENFit, Straight	71	M00513382	Radial Jaw 4 Standard Capacity Single-Use Biopsy Forceps	67
M00509961	EndoVive Replacement Gastrostomy Feeding Tube, with ENFit, Right Angle	71	M00513383	Radial Jaw 4 Standard Capacity Single-Use Biopsy Forceps	67
M00509971	EndoVive Replacement Gastrostomy Feeding Tube, with ENFit, Right Angle	71	M00513391	Radial Jaw 4 Standard Capacity Single-Use Biopsy Forceps w/ Needle	67
M00509981	EndoVive Replacement Gastrostomy Feeding Tube, with ENFit, Right Angle	71	M00513392	Radial Jaw 4 Standard Capacity Single-Use Biopsy Forceps w/ Needle	67
M00509991	EndoVive Replacement Gastrostomy Feeding Tube, with ENFit, Right Angle	71	M00513393	Radial Jaw 4 Standard Capacity Single-Use Biopsy Forceps w/ Needle	67
M00510001	EndoVive Replacement Gastrostomy Feeding Tube, with ENFit, Right Angle	71	M00513401	Radial Jaw 4 Standard Capacity Single-Use Biopsy Forceps	67
M00510011	EndoVive Replacement Gastrostomy Feeding Tube, with ENFit, Right Angle	71	M00513402	Radial Jaw 4 Standard Capacity Single-Use Biopsy Forceps	67
M00510021	EndoVive Replacement Gastrostomy Feeding Tube, with ENFit, Right Angle	71	M00513403	Radial Jaw 4 Standard Capacity Single-Use Biopsy Forceps	67
M00510860	Trapezoid™ RX Wireguided Retrieval Basket	29	M00513411	Radial Jaw 4 Standard Capacity Single-Use Biopsy Forceps w/ Needle	67
M00510870	Trapezoid RX Wireguided Retrieval Basket	29	M00513412	Radial Jaw 4 Standard Capacity Single-Use Biopsy Forceps w/ Needle	67
M00510880	Trapezoid RX Wireguided Retrieval Basket	29	M00513413	Radial Jaw 4 Standard Capacity Single-Use Biopsy Forceps w/ Needle	67
M00510890	Trapezoid RX Wireguided Retrieval Basket	29	M00513443	Radial Jaw 4 Single-Use Pediatric Biopsy Forceps	68
M00513200	Zero Tip™ Airway Retrieval Basket	93	M00513453	Radial Jaw 4 Single-Use Pediatric Biopsy Forceps w/ Needle	68
M00513210	Zero Tip Airway Retrieval Basket	93	M00513700	Ultraflex™ Esophageal NG Uncovered Stent System – Distal Release	47
M00513301	Radial Jaw™ 4 Single-Use Large Capacity Biopsy Forceps	67	M00513710	Ultraflex Esophageal NG Uncovered Stent System – Distal Release	47
M00513302	Radial Jaw 4 Single-Use Large Capacity Biopsy Forceps	67	M00513720	Ultraflex Esophageal NG Uncovered Stent System – Distal Release	47
M00513303	Radial Jaw 4 Single-Use Large Capacity Biopsy Forceps	67	M00513730	Ultraflex Esophageal NG Covered Stent System – Distal Release	46
M00513311	Radial Jaw 4 Single-Use Large Capacity Biopsy Forceps w/ Needle	67	M00513740	Ultraflex Esophageal NG Covered Stent System – Distal Release	46
M00513312	Radial Jaw 4 Single-Use Large Capacity Biopsy Forceps w/ Needle	67	M00513750	Ultraflex Esophageal NG Covered Stent System – Distal Release	46
M00513313	Radial Jaw 4 Single-Use Large Capacity Biopsy Forceps w/ Needle	67	M00513800	Ultraflex Esophageal NG Uncovered Stent System – Proximal Release	47
M00513321	Radial Jaw 4 Single-Use Large Capacity Biopsy Forceps	67	M00513810	Ultraflex Esophageal NG Uncovered Stent System – Proximal Release	47
M00513322	Radial Jaw 4 Single-Use Large Capacity Biopsy Forceps	67			

Product Code Index

Product Code	Description	Page #	Product Code	Description	Page #
M00513830	Ultraflex™ Esophageal NG Uncovered Stent System – Proximal Release	47	M00517210	AGILE Esophageal Stent System	44
M00513840	Ultraflex Esophageal NG Covered Stent System – Proximal Release	46	M00517220	AGILE Esophageal Stent System	44
M00513850	Ultraflex Esophageal NG Covered Stent System – Proximal Release	46	M00517230	AGILE Esophageal Stent System	44
M00513860	Ultraflex Esophageal NG Covered Stent System – Proximal Release	46	M00517240	AGILE Esophageal Stent System	44
M00514200	Ultraflex Esophageal NG Covered Stent System – Distal Release	46	M00517250	AGILE Esophageal Stent System	44
M00514210	Ultraflex Esophageal NG Covered Stent System – Distal Release	46	M00517260	AGILE Esophageal Stent System	44
M00514240	Ultraflex Esophageal NG Covered Stent System – Proximal Release	47	M00517270	AGILE Esophageal Stent System	44
M00514250	Ultraflex Esophageal NG Covered Stent System – Proximal Release	47	M00517400	AGILE Esophageal Stent System	44
M00515031	Radial Jaw™ 4 Single-Use Hot Biopsy Forceps	68	M00517410	AGILE Esophageal Stent System	44
M00515032	Radial Jaw 4 Single-Use Hot Biopsy Forceps	68	M00517420	AGILE Esophageal Stent System	44
M00515033	Radial Jaw 4 Single-Use Hot Biopsy Forceps	68	M00517430	AGILE Esophageal Stent System	44
M00515171	Pulmonary Jagwire™ Pulmonary Guidewire	94	M00517440	AGILE Esophageal Stent System	44
M00515181	Radial Jaw 4 Single-Use Pulmonary Forceps – Standard Capacity	91	M00517450	AGILE Esophageal Stent System	44
M00515182	Radial Jaw 4 Single-Use Pulmonary Forceps – Standard Capacity	91	M00517460	AGILE Esophageal Stent System	44
M00515191	Radial Jaw 4 Single-Use Pulmonary Forceps – Standard Capacity with Needle	91	M00517470	AGILE Esophageal Stent System	44
M00515192	Radial Jaw 4 Single-Use Pulmonary Forceps – Standard Capacity with Needle	91	M00517710	AGILE ESO Esophageal Stent System	44
M00515201	Radial Jaw 4 Single-Use Pulmonary Forceps – Large Capacity	91	M00517720	AGILE ESO Esophageal Stent System	44
M00515202	Radial Jaw 4 Single-Use Pulmonary Forceps – Large Capacity	91	M00517730	AGILE ESO Esophageal Stent System	44
M00515220	CoreDx™ Pulmonary Mini-Forceps for Endobronchial Ultrasound	92	M00517740	AGILE ESO Esophageal Stent System	44
M00516001	Celebrity™ Single-Use Endoscopic Cytology Brush	93	M00517750	AGILE ESO Esophageal Stent System	44
M00516011	Celebrity Single-Use Endoscopic Cytology Brush	93	M00517760	AGILE ESO Esophageal Stent System	44
M00516071	Celebrity Single-Use Endoscopic Cytology Brush	93	M00517770	AGILE ESO Esophageal Stent System	44
M00516151	Celebrity Single-Use Endoscopic Cytology Brush	93	M00517780	AGILE ESO Esophageal Stent System	44
M00516700	WallFlex™ Fully Covered Esophageal Stent System	45	M00518101	Interject™ Clear Single-Use Injection Therapy Needle Catheters	50
M00516710	WallFlex Fully Covered Esophageal Stent System	45	M00518111	Interject Clear Single-Use Injection Therapy Needle Catheters	50
M00516720	WallFlex Fully Covered Esophageal Stent System	45	M00518151	Interject Contrast Single-Use Injection Therapy Needle Catheters	50
M00516730	WallFlex Fully Covered Esophageal Stent System	45	M00518161	Interject Contrast Single-Use Injection Therapy Needle Catheters	50
M00516740	WallFlex Fully Covered Esophageal Stent System	45	M00518251	Interject Contrast Single-Use Injection Therapy Needle Catheters	50
M00516750	WallFlex Fully Covered Esophageal Stent System	45	M00518261	Interject Contrast Single-Use Injection Therapy Needle Catheters	50
M00516900	WallFlex Partially Covered Esophageal Stent System	45	M00518301	Interject Clear Single-Use Injection Therapy Needle Catheters	50
M00516910	WallFlex Partially Covered Esophageal Stent System	45	M00518311	Interject Clear Single-Use Injection Therapy Needle Catheters	50
M00516920	WallFlex Partially Covered Esophageal Stent System	45	M00518351	Interject Contrast Single-Use Injection Therapy Needle Catheters	50
M00516930	WallFlex Partially Covered Esophageal Stent System	45	M00518361	Interject Contrast Single-Use Injection Therapy Needle Catheters	50
M00516940	WallFlex Partially Covered Esophageal Stent System	45	M00519351	ORISE™ ProKnife	82
M00516950	WallFlex Partially Covered Esophageal Stent System	45	M00519361	ORISE ProKnife	82
M00517200	AGILE™ Esophageal Stent System	44	M00519371	ORISE ProKnife	82
			M00521230	Resolution 360™ Clip	48, 54
			M00521231	Resolution 360 Clip	48, 54

▶ Product Code Index

Product Code	Description	Page #	Product Code	Description	Page #
M00521232	Resolution 360 Clip	48, 54	M00532920	Advanix Duodenal Bend - Single Stent	18
M00521233	Resolution 360 Clip	48, 54	M00532930	Advanix Duodenal Bend - Single Stent	18
M00521240	Resolution 360 Clip	48, 54	M00532940	Advanix Duodenal Bend - Single Stent	18
M00521241	Resolution 360 Clip	48, 54	M00532950	Advanix Duodenal Bend - Single Stent	18
M00521242	Resolution 360 Clip	48, 54	M00532960	Advanix Duodenal Bend - Single Stent	18
M00521400	Resolution 360 ULTRA Clip	48, 54	M00532970	Advanix Duodenal Bend - Single Stent	18
M00521401	Resolution 360 ULTRA Clip	48, 54	M00532980	Advanix Duodenal Bend - Single Stent	18
M00521402	Resolution 360 ULTRA Clip	48, 54	M00532990	Advanix Duodenal Bend - Single Stent	18
M00521403	Resolution 360 ULTRA Clip	48, 54	M00533000	Advanix Duodenal Bend - Single Stent	18
M00521420	MANTIS™ Clip	48, 54	M00533010	Advanix Duodenal Bend - Single Stent	18
M00521421	MANTIS Clip	48, 54	M00533020	Advanix Duodenal Bend - Single Stent	18
M00521422	MANTIS Clip	48, 54	M00533030	Advanix Duodenal Bend - Single Stent	18
M00522600	Resolution™ Clip	49, 55	M00533040	Advanix Duodenal Bend - Single Stent	18
M00522601	Resolution Clip	49, 55	M00533230	Advanix Center Bend - Single Stent	18
M00522602	Resolution Clip	49, 55	M00533240	Advanix Center Bend - Single Stent	18
M00522610	Resolution Clip	49, 55	M00533250	Advanix Center Bend - Single Stent	18
M00522611	Resolution Clip	49, 55	M00533260	Advanix Center Bend - Single Stent	18
M00522612	Resolution Clip	49, 55	M00533270	Advanix Center Bend - Single Stent	18
M00527451	Rescue™ Alligator Grasping Forceps	83	M00533280	Advanix Center Bend - Single Stent	18
M00527751	Rescue Rat Tooth PED Grasping Forceps	83	M00533290	Advanix Center Bend - Single Stent	18
M00530800	Ultratome™ Double-Lumen Sphincterotome – Short Nose	11	M00533300	Advanix Center Bend - Single Stent	18
M00530810	Ultratome Double-Lumen Sphincterotome – Long Nose	11	M00533310	Advanix Center Bend - Single Stent	18
M00530820	Ultratome Double-Lumen Sphincterotome – Short Nose	11	M00533320	Advanix Center Bend - Single Stent	18
M00530830	Ultratome Double-Lumen Sphincterotome – Long Nose	11	M00533330	Advanix Center Bend - Single Stent	18
M00530850	Contour™ ERCP Cannulas – Standard	12	M00533340	Advanix Center Bend - Single Stent	18
M00530860	Contour ERCP Cannulas – Tapered	12	M00533350	Advanix Center Bend - Single Stent	18
M00530870	Contour ERCP Cannulas – Ultra Tapered	12	M00533360	Advanix Center Bend - Single Stent	19
M00530880	Contour ERCP Cannulas – 5-4-3	12	M00533370	Advanix Center Bend - Single Stent	18
M00530890	Contour ERCP Cannulas – Ball Tip	12	M00533380	Advanix Center Bend - Single Stent	18
M00532160	Advanix™ Double Pigtail - Single Stent	19	M00533390	Advanix Center Bend - Single Stent	18
M00532180	Advanix Double Pigtail - Single Stent	19	M00533400	Advanix Center Bend - Single Stent	18
M00532190	Advanix Double Pigtail - Single Stent	19	M00533560	NaviFlex™ RX Delivery System	19
M00532210	Advanix Double Pigtail - Single Stent	19	M00533570	NaviFlex RX Delivery System	19
M00532220	Advanix Double Pigtail - Single Stent	19	M00533580	NaviFlex RX Delivery System	19
M00532230	Advanix Double Pigtail - Single Stent	19	M00534200	Advanix Duodenal Bend Preloaded RX Stent Systems	17
M00532240	Advanix Double Pigtail - Single Stent	19	M00534210	Advanix Duodenal Bend Preloaded RX Stent Systems	17
M00532260	Advanix Double Pigtail - Single Stent	19	M00534220	Advanix Duodenal Bend Preloaded RX Stent Systems	17
M00532270	Advanix Double Pigtail - Single Stent	19	M00534230	Advanix Duodenal Bend Preloaded RX Stent Systems	17
M00532290	Advanix Double Pigtail - Single Stent	19	M00534240	Advanix Duodenal Bend Preloaded RX Stent Systems	17
M00532300	Advanix Double Pigtail - Single Stent	19	M00534250	Advanix Duodenal Bend Preloaded RX Stent Systems	17
M00532310	Advanix Double Pigtail - Single Stent	19	M00534260	Advanix Duodenal Bend Preloaded RX Stent Systems	17
M00532810	MicroKnife™ XL Triple-Lumen Needle Knife	9	M00534270	Advanix Duodenal Bend Preloaded RX Stent Systems	17
M00532870	Advanix Duodenal Bend - Single Stent	18	M00534280	Advanix™ Duodenal Bend Preloaded RX Stent Systems	17
M00532880	Advanix Duodenal Bend - Single Stent	18	M00534290	Advanix Duodenal Bend Preloaded RX Stent Systems	17
M00532890	Advanix Duodenal Bend - Single Stent	18	M00534300	Advanix Duodenal Bend Preloaded RX Stent Systems	17
M00532900	Advanix Duodenal Bend - Single Stent	18	M00534310	Advanix Duodenal Bend Preloaded RX Stent Systems	17
M00532910	Advanix Duodenal Bend - Single Stent	18	M00534320	Advanix Duodenal Bend Preloaded RX Stent Systems	17

▶ Product Code Index

Product Code	Description	Page #	Product Code	Description	Page #
M00534330Advanix Duodenal Bend Preloaded RX Stent Systems	17	M00536060Advanix Pancreatic Stent – Straight, No Leading Barb	23
M00534340Advanix Duodenal Bend Preloaded RX Stent Systems	17	M00536070Advanix Pancreatic Stent – Straight, No Leading Barb	23
M00534350Advanix Duodenal Bend Preloaded RX Stent Systems	17	M00536080Advanix Pancreatic Stent – Straight, No Leading Barb	23
M00534360Advanix Duodenal Bend Preloaded RX Stent Systems	17	M00536090Advanix Pancreatic Stent – Straight, No Leading Barb	23
M00534370Advanix Duodenal Bend Preloaded RX Stent Systems	17	M00536100Advanix Pancreatic Stent – Straight, No Leading Barb	23
M00534560Advanix Center Bend Preloaded RX Stent Systems	17	M00536110Advanix Pancreatic Stent – Straight, No Leading Barb	23
M00534570Advanix Center Bend Preloaded RX Stent Systems	17	M00536120Advanix Pancreatic Stent – Straight, No Leading Barb	23
M00534580Advanix Center Bend Preloaded RX Stent Systems	17	M00536130Advanix Pancreatic Stent – Straight, No Leading Barb	23
M00534590Advanix Center Bend Preloaded RX Stent Systems	17	M00536140Advanix Pancreatic Stent – Straight, No Leading Barb	23
M00534600Advanix Center Bend Preloaded RX Stent Systems	17	M00536150Advanix Pancreatic Stent – Straight, No Leading Barb	23
M00534610Advanix Center Bend Preloaded RX Stent Systems	17	M00536160Advanix Pancreatic Stent – Straight, No Leading Barb	23
M00534620Advanix Center Bend Preloaded RX Stent Systems	17	M00536170Advanix Pancreatic Stent – Straight, No Leading Barb	23
M00534630Advanix Center Bend Preloaded RX Stent Systems	17	M00536180Advanix Pancreatic Stent – Straight, No Leading Barb	23
M00534640Advanix Center Bend Preloaded RX Stent Systems	17	M00536190Advanix Pancreatic Stent – Straight, No Leading Barb	23
M00534650Advanix Center Bend Preloaded RX Stent Systems	17	M00536200Advanix Pancreatic Stent – Straight, No Leading Barb	23
M00534660Advanix Center Bend Preloaded RX Stent Systems	17	M00536210Advanix Pancreatic Stent – Straight, No Leading Barb	23
M00534670Advanix Center Bend Preloaded RX Stent Systems	17	M00536220Advanix Pancreatic Stent – Straight, No Leading Barb	23
M00534680Advanix Center Bend Preloaded RX Stent Systems	17	M00536230Advanix Pancreatic Stent – Straight, No Leading Barb	23
M00534690Advanix Center Bend Preloaded RX Stent Systems	17	M00536240Advanix Pancreatic Stent – Straight, No Leading Barb	23
M00534700Advanix Center Bend Preloaded RX Stent Systems	17	M00536250Advanix Pancreatic Stent – Straight, No Leading Barb	23
M00534710Advanix Center Bend Preloaded RX Stent Systems	17	M00536260Advanix Pancreatic Stent – Straight, No Leading Barb	23
M00534720Advanix Center Bend Preloaded RX Stent Systems	17	M00536270Advanix Pancreatic Stent – Straight, No Leading Barb	23
M00534730Advanix Center Bend Preloaded RX Stent Systems	17	M00536280Advanix Pancreatic Stent – Straight, No Leading Barb	23
M00535000NaviFlex™ Pancreatic Stent RX Pusher	27	M00536290Advanix Pancreatic Stent – Straight, No Leading Barb	23
M00535010NaviFlex Pancreatic Stent RX Pusher	27	M00536300Advanix Pancreatic Stent – Straight, No Leading Barb	23
M00535020NaviFlex Pancreatic Stent Pusher	27	M00536310Advanix Pancreatic Stent – Straight, No Leading Barb	23
M00535030NaviFlex Pancreatic Stent Pusher	27	M00536320Advanix Pancreatic Stent – Straight, No Leading Barb	23
M00535060NaviFlex RX Pancreatic Stent Delivery System	27	M00536330Advanix Pancreatic Stent – Straight, No Leading Barb	23
M00535080NaviFlex RX Pancreatic Stent Delivery System	27	M00536340Advanix Pancreatic Stent – Straight, No Leading Barb	23
M00535110Stonetome™ Stone Removal Device	10	M00536350Advanix Pancreatic Stent – Straight, No Leading Barb	23
M00535130Stonetome Stone Removal Device	10	M00536360Advanix Pancreatic Stent – Straight, Leading Barb	24
M00535150Stonetome Stone Removal Device	10	M00536370Advanix Pancreatic Stent – Straight, Leading Barb	24
M00535170Stonetome Stone Removal Device	10	M00536380Advanix Pancreatic Stent – Straight, Leading Barb	24
M00535190Stonetome Stone Removal Device	10	M00536390Advanix Pancreatic Stent – Straight, Leading Barb	24
M00535210Stonetome Stone Removal Device	10	M00536400Advanix Pancreatic Stent – Straight, Leading Barb	24
M00535700Tandem™ XL Triple-Lumen ERCP Cannula – Tapered	12	M00536410Advanix Pancreatic Stent – Straight, Leading Barb	24
M00535900Ultratome™ XL Triple-Lumen Sphincterotome – Short Nose	10	M00536420Advanix Pancreatic Stent – Straight, Leading Barb	24
M00535910Ultratome XL Triple-Lumen Sphincterotome – Long Nose	10	M00536430Advanix Pancreatic Stent – Straight, Leading Barb	24
M00535920Ultratome XL Triple-Lumen Sphincterotome – Short Nose	10	M00536440Advanix Pancreatic Stent – Straight, Leading Barb	24
M00535930Ultratome XL Triple-Lumen Sphincterotome – Long Nose	10	M00536450Advanix Pancreatic Stent – Straight, Leading Barb	24
M00536000Advanix Pancreatic Stent – Straight, No Leading Barb	23	M00536460Advanix Pancreatic Stent – Straight, Leading Barb	24
M00536010Advanix Pancreatic Stent – Straight, No Leading Barb	23	M00536470Advanix Pancreatic Stent – Straight, Leading Barb	24
M00536020Advanix Pancreatic Stent – Straight, No Leading Barb	23	M00536480Advanix™ Pancreatic Stent – Straight, Leading Barb	24
M00536030Advanix Pancreatic Stent – Straight, No Leading Barb	23	M00536490Advanix Pancreatic Stent – Straight, Leading Barb	24
M00536040Advanix Pancreatic Stent – Straight, No Leading Barb	23	M00536500Advanix Pancreatic Stent – Straight, Leading Barb	24
M00536050Advanix Pancreatic Stent – Straight, No Leading Barb	23	M00536510Advanix Pancreatic Stent – Straight, Leading Barb	24
			M00536520Advanix Pancreatic Stent – Straight, Leading Barb	24

▶ Product Code Index

Product Code	Description	Page #	Product Code	Description	Page #
M00537470	Advanix Pancreatic Stent Kit – Straight, No Leading Barb	22	M00542981	SpyGlass Discover Imager™ II IOC Catheter	33
M00537480	Advanix Pancreatic Stent Kit – Straight, No Leading Barb	22	M00542990	SpyGlass Discover Retrieval Basket Box	33
M00537490	Advanix Pancreatic Stent Kit – Straight, No Leading Barb	22	M00543000	SpyGlass Discover Balloon Dilation Catheter	33
M00537500	Advanix Pancreatic Stent Kit – Straight, No Leading Barb	22	M00543010	SpyGlass Discover Balloon Dilation Catheter	33
M00537510	Advanix Pancreatic Stent Kit – Straight, No Leading Barb	22	M00543040	SpyGlass Discover Balloon Dilation Catheter	33
M00537520	Advanix Pancreatic Stent Kit – Straight, No Leading Barb	22	M00545000	RX Cytology Brush Wireguided Cytology Brush	32
M00537530	Advanix Pancreatic Stent Kit – Straight, No Leading Barb	22	M00545101	AutoCap RX Olympus Compatible (TJF-160, TJF-180, TJF-190 and JF-260V Series Duodenoscopes)	13
M00537540	Advanix Pancreatic Stent Kit – Straight, Leading Barb	22	M00545131	AutoCap RX EXALT™ Model D Compatible Integrated Biopsy	13
M00537550	Advanix Pancreatic Stent Kit – Straight, Leading Barb	22	M00545150	Autotome™ RX 49 Cannulating Sphincterotome	7
M00537560	Advanix Pancreatic Stent Kit – Straight, Leading Barb	22	M00545160	Autotome RX 49 Cannulating Sphincterotome	7
M00538351	Rescue Retrieval Single-Use Grasping Forceps	83	M00545170	Autotome RX 44 Cannulating Sphincterotome	7
M00539200	Flexima™ Duodenal Bend Biliary Stent with Delivery System	20	M00545180	Autotome RX 44 Cannulating Sphincterotome	7
M00539210	Flexima Duodenal Bend Biliary Stent with Delivery System	20	M00545190	Autotome RX 39 Cannulating Sphincterotome	7
M00539220	Flexima Duodenal Bend Biliary Stent with Delivery System	20	M00545200	Autotome RX 39 Cannulating Sphincterotome	7
M00539230	Flexima Duodenal Bend Biliary Stent with Delivery System	20	M00545211	RX Locking Device Olympus™ / FujiFilm™ Brand Endoscope Compatible	13
M00539240	Flexima Duodenal Bend Biliary Stent with Delivery System	20	M00545261	RX Locking Device and Biopsy Cap System – Olympus FujiFilm G5 Series Brand Endoscope Compatible	13
M00539250	Flexima Duodenal Bend Biliary Stent with Delivery System	20	M00545271	RX Locking Device and Biopsy Cap System – Pentax™ Brand Endoscope Compatible	13
M00539260	Flexima Duodenal Bend Biliary Stent with Delivery System	20	M00545281	RX Locking Device and Biopsy Cap System – FujiFilm Type 3 Brand Endoscope Compatible	13
M00539270	Flexima Duodenal Bend Biliary Stent with Delivery System	20	M00545550	RX Duodenal Bend Biliary Stent with RX Delivery System	20
M00539280	Flexima Duodenal Bend Biliary Stent with Delivery System	20	M00545560	RX Duodenal Bend Biliary Stent with RX Delivery System	20
M00539290	Flexima Duodenal Bend Biliary Stent with Delivery System	20	M00545570	RX Duodenal Bend Biliary Stent with RX Delivery System	20
M00539300	Flexima Duodenal Bend Biliary Stent with Delivery System	20	M00545580	RX Duodenal Bend Biliary Stent with RX Delivery System	20
M00539310	Flexima Duodenal Bend Biliary Stent with Delivery System	20	M00545590	RX Duodenal Bend Biliary Stent with RX Delivery System	20
M00539320	Flexima Duodenal Bend Biliary Stent with Delivery System	20	M00545600	RX Duodenal Bend Biliary Stent with RX Delivery System	20
M00539330	Flexima Duodenal Bend Biliary Stent with Delivery System	20	M00545610	RX Duodenal Bend Biliary Stent with RX Delivery System	20
M00539340	Flexima Duodenal Bend Biliary Stent with Delivery System	20	M00545620	RX Duodenal Bend Biliary Stent with RX Delivery System	20
M00539350	Flexima Duodenal Bend Biliary Stent with Delivery System	20	M00545630	RX Duodenal Bend Biliary Stent with RX Delivery System	20
M00539360	Flexima Duodenal Bend Biliary Stent with Delivery System	20	M00545640	RX Duodenal Bend Biliary Stent with RX Delivery System	20
M00539370	Flexima Duodenal Bend Biliary Stent with Delivery System	20	M00545650	RX Duodenal Bend Biliary Stent with RX Delivery System	20
M00539380	Flexima Duodenal Bend Biliary Stent with Delivery System	20	M00545660	RX Duodenal Bend Biliary Stent with RX Delivery System	20
M00539390	Flexima Duodenal Bend Biliary Stent with Delivery System	20	M00545670	RX Duodenal Bend Biliary Stent with RX Delivery System	20
M00540110	Flexima Single Pigtail Nasobiliary Catheter	21	M00545680	RX Duodenal Bend Biliary Stent with RX Delivery System	20
M00540120	Flexima Single Pigtail Nasobiliary Catheter	21	M00545690	RX Duodenal Bend Biliary Stent with RX Delivery System	20
M00540130	Flexima Single Pigtail Nasobiliary Catheter	21	M00545700	RX Duodenal Bend Biliary Stent with RX Delivery System	20
M00540140	Flexima Single Pigtail Nasobiliary Catheter	21	M00545710	RX Duodenal Bend Biliary Stent with RX Delivery System	20
M00542250	Speedband Superview Super 7™ Multiple Band Ligators	51	M00545720	RX Duodenal Bend Biliary Stent with RX Delivery System	20
M00542251	Speedband Superview Super 7™ Multiple Band Ligators	51	M00545730	RX Duodenal Bend Biliary Stent with RX Delivery System	20
M00542253	Speedband Superview Super 7 Multiple Band Ligators	51	M00545740	RX Duodenal Bend Biliary Stent with RX Delivery System	20
M00542420	EXALT™ Model D Single-use Duodenoscope	36	M00545760	RX ERCP Cannula – Standard Tip	11
M00542421	EXALT Model D Single-use Duodenoscope	36	M00545770	RX ERCP Cannula – Tapered Tip	11
M00542423	EXALT Model D Single-use Duodenoscope	36	M00545780	RX ERCP Cannula – Ball Tip	11
M00542424	EXALT Model D Single-use Duodenoscope	36	M00545820	Rapid Exchange XL Cannula	11
M00542430	EXALT Controller	36	M00545840	RX Needle Knife XL Triple-Lumen Needle Knife	7
M00542950	SpyGlass™ Discover Controller	33			
M00542961	Super Sheath CBDE for use with the SpyGlass	33			
M00542971	SpyGlass Discover Jagwire™ Guidewire	33			

Product Code Index

Product Code	Description	Page #	Product Code	Description	Page #
M00545890	Hurricane™ RX Biliary Balloon Dilatation Catheter	31	M00550320	CRE Pulmonary Balloon Dilatation Catheter	94
M00545900	Hurricane RX Biliary Balloon Dilatation Catheter	31	M00550330	CRE Pulmonary Balloon Dilatation Catheter	94
M00545910	Hurricane RX Biliary Balloon Dilatation Catheter	31	M00550340	CRE Pulmonary Balloon Dilatation Catheter	94
M00545920	Hurricane RX Biliary Balloon Dilatation Catheter	31	M00550350	CRE Pulmonary Balloon Dilatation Catheter	94
M00545930	Hurricane RX Biliary Balloon Dilatation Catheter	31	M00550601	Alliance™ II Integrated Inflation / Lithotripsy Device and Alliance II Syringe / Gauge Assembly	66, 94
M00545940	Hurricane RX Biliary Balloon Dilatation Catheter	31	M00550620	Alliance II Integrated Inflation / Lithotripsy Device – Inflation Handle	66, 94
M00545950	Hurricane RX Biliary Balloon Dilatation Catheter	31	M00550630	CRE SteriFlate Disposable Inflation Device	66
M00545960	Hurricane RX Biliary Balloon Dilatation Catheter	31	M00552001	NovaGold™ High Performance Guidewire	3
M00546470	SpyBite™ Max Biopsy Forceps	34	M00552011	NovaGold High Performance Guidewire	3
M00546550	SpyGlass™ Retrieval Basket	34	M00552350	Acquire™ Pulmonary Endobronchial Ultrasound Fine Needle Biopsy Device	92
M00546560	SpyGlass™ Retrieval Snare	34	M00552400	Acquire™ Pulmonary Endobronchial Ultrasound Fine Needle Biopsy Device	92
M00546610	SpyScope DS II Access & Delivery Catheter	34	M00553200	Inflation / Deflation Devices and Accessories – Pneumatic Inflator	66
M00546620	Biliary Electrohydraulic Lithotripter Probe	35	M00553640	AXIOS™ Stent and Electrocautery Enhanced Delivery System	41
M00546650	SpyGlass DS Digital Controller	34	M00553650	AXIOS Stent and Electrocautery Enhanced Delivery System	41
M005466800	Autolith™ Touch Bipolar Electrohydraulic Lithotripter	35	M00553660	AXIOS Stent and Electrocautery Enhanced Delivery System	41
M00546750	Autolith Touch Extender Cable	35	M00553670	AXIOS Stent and Electrocautery Enhanced Delivery System	41
M00546760	Autolith Touch Foot Switch	35	M00553680	AXIOS Stent and Electrocautery Enhanced Delivery System	41
M00546780	SpyGlass™ Discover Digital Catheter	33	M00553690	AXIOS Stent and Electrocautery Enhanced Delivery System	41
M00547000	Extractor™ Pro RX Retrieval Balloon Catheter – Distal Injection	28	M00553740	AXIOS Stent and Delivery System	41
M00547010	Extractor Pro RX Retrieval Balloon Catheter – Distal Injection	28	M00553750	AXIOS Stent and Delivery System	41
M00547020	Extractor Pro RX Retrieval Balloon Catheter – Distal Injection	28	M00553831	Lumicoil™ Platinum Fiducial Marker – Straight	41
M00547030	Extractor Pro RX Retrieval Balloon Catheter – Proximal Injection	28	M00553841	Lumicoil Platinum Fiducial Marker – Figure 8	41
M00547040	Extractor Pro RX Retrieval Balloon Catheter – Proximal Injection	28	M00554500	Rigiflex™ II Single-Use Achalasia Balloon Dilators	65
M00547050	Extractor Pro RX Retrieval Balloon Catheter – Proximal Injection	28	M00554510	Rigiflex II Single-Use Achalasia Balloon Dilators	65
M00547100	Extractor Pro XL Retrieval Balloon Catheter – Distal Injection	29	M00554520	Rigiflex II Single-Use Achalasia Balloon Dilators	65
M00547110	Extractor Pro XL Retrieval Balloon Catheter – Distal Injection	29	M00555500	Expect™ Slimline (SL) Endoscopic Ultrasound Aspiration Needle	40
M00547120	Extractor Pro XL Retrieval Balloon Catheter – Distal Injection	29	M00555501	Expect Slimline (SL) Endoscopic Ultrasound Aspiration Needle	40
M00547130	Extractor Pro XL Retrieval Balloon Catheter – Proximal Injection	29	M00555510	Expect Slimline (SL) Endoscopic Ultrasound Aspiration Needle	40
M00547140	Extractor Pro XL Retrieval Balloon Catheter – Proximal Injection	29	M00555520	Expect Slimline (SL) Endoscopic Ultrasound Aspiration Needle	40
M00547150	Extractor Pro XL Retrieval Balloon Catheter – Proximal Injection	29	M00555530	Expect Slimline (SL) Endoscopic Ultrasound Aspiration Needle	40
M00547300	Extractor Pro RX-S Retrieval Balloon Catheter – Distal Injection	28	M00555511	Expect Slimline (SL) Endoscopic Ultrasound Aspiration Needle	40
M00547310	Extractor Pro RX-S Retrieval Balloon Catheter – Distal Injection	28	M00555521	Expect Slimline (SL) Endoscopic Ultrasound Aspiration Needle	40
M00547320	Extractor Pro RX-S Retrieval Balloon Catheter – Distal Injection	28	M00555531	Expect Slimline (SL) Endoscopic Ultrasound Aspiration Needle	40
M00547330	Extractor Pro RX-S Retrieval Balloon Catheter – Proximal Injection	28	M00555540	Acquire™ Endoscopic Ultrasound Fine Needle Biopsy (FNB) Device	40
M00547340	Extractor Pro RX-S Retrieval Balloon Catheter – Proximal Injection	28	M00555541	Acquire Endoscopic Ultrasound Fine Needle Biopsy (FNB) Device	40
M00547350	Extractor Pro RX-S Retrieval Balloon Catheter – Proximal Injection	28	M00555560	Acquire Endoscopic Ultrasound Fine Needle Biopsy (FNB) Device	40
M00547420	WallFlex™ Biliary RX Partially Covered Stent System	15	M00555561	Acquire Endoscopic Ultrasound Fine Needle Biopsy (FNB) Device	40
M00547440	WallFlex Biliary RX Partially Covered Stent System	15	M00555580	Acquire Endoscopic Ultrasound Fine Needle Biopsy (FNB) Device	40
M00547460	WallFlex™ Biliary RX Fully Covered Stent System	14	M00555640	Acquire™ S Endoscopic Ultrasound Fine Needle Biopsy (FNB) Device	40
M00547480	WallFlex Biliary RX Fully Covered Stent System	14	M00555660	Acquire S 25ga	40
M00550090	Amplatz Super Stiff™ Guidewires – Straight Tip	1, 47, 94	M00555760	WallFlex™ Soft Colonic Stent System	42
M00550300	CRE™ Pulmonary Balloon Dilatation Catheter	94	M00555770	WallFlex Soft Colonic Stent System	42
M00550310	CRE Pulmonary Balloon Dilatation Catheter	94	M00555780	WallFlex Soft Colonic Stent System	42

Product Code Index

Product Code	Description	Page #	Product Code	Description	Page #
M0055860	WallFlex Soft Duodenal Stent System	43	M00556661	Jagwire High Performance Guidewire – Stiff Shaft – Angled	2
M0055870	WallFlex Soft Duodenal Stent System	43	M00556841	Jagwire Extendable High Performance Guidewire – Straight	2
M0055880	WallFlex Soft Duodenal Stent System	43	M00556851	Jagwire Extendable High Performance Guidewire – Angled	2
M00556001	Hydra Jagwire™ High Performance Guidewire – Straight	1	M00556861	Jagwire Extendable High Performance Guidewire – Stiff Shaft – Straight	2
M00556011	Hydra Jagwire High Performance Guidewire – Angled	1	M00556871	Jagwire Extendable High Performance Guidewire – Stiff Shaft – Angled	2
M00556021	Hydra Jagwire High Performance Guidewire – Stiff Shaft – Straight	1	M00556902	Jagtail™ High Performance Guidewire Extension	2
M00556031	Hydra Jagwire High Performance Guidewire – Stiff Shaft – Angled	1	M00557001	Jagwire Revolution High Performance Guidewire – Straight	2
M00556041	Hydra Jagwire High Performance Guidewire – Straight	1	M00557011	Jagwire Revolution High Performance Guidewire – Angled	2
M00556051	Hydra Jagwire High Performance Guidewire – Angled	1	M00557021	Jagwire Revolution High Performance Guidewire – Straight	2
M00556061	Hydra Jagwire High Performance Guidewire – Stiff Shaft – Straight	1	M00557031	Jagwire Revolution High Performance Guidewire – Angled	2
M00556071	Hydra Jagwire™ High Performance Guidewire – Stiff Shaft – Angled	1	M00557041	Jagwire Revolution High Performance Guidewire – Straight	2
M00556101	Dreamwire™ High Performance Guidewire – Standard Shaft	1	M00558220	Expect™ Pulmonary Endobronchial Ultrasound Transbronchial Aspiration Needle	92
M00556111	Dreamwire High Performance Guidewire – Standard Shaft	1	M00558250	Expect Pulmonary Endobronchial Ultrasound Transbronchial Aspiration Needle	92
M00556121	Dreamwire High Performance Guidewire – Stiff Shaft	1	M00558330	CRE™ Fixed Wire Esophageal Balloon Dilatation Catheters	61
M00556131	Dreamwire High Performance Guidewire – Stiff Shaft	1	M00558340	CRE Fixed Wire Esophageal Balloon Dilatation Catheters	61
M00556141	Dreamwire High Performance Guidewire – Standard Shaft	1	M00558350	CRE Fixed Wire Esophageal Balloon Dilatation Catheters	61
M00556151	Dreamwire High Performance Guidewire – Standard Shaft	1	M00558360	CRE Fixed Wire Esophageal Balloon Dilatation Catheters	61
M00556161	Dreamwire High Performance Guidewire – Stiff Shaft	1	M00558361	CRE Fixed Wire Esophageal Balloon Dilatation Catheters	61
M00556171	Dreamwire High Performance Guidewire – Stiff Shaft	1	M00558370	CRE Fixed Wire Esophageal Balloon Dilatation Catheters	61
M00556181	NaviPro™ Hydrophilic Guidewire	3	M00558371	CRE Fixed Wire Esophageal Balloon Dilatation Catheters	61
M00556191	NaviPro Hydrophilic Guidewire	3	M00558380	CRE Fixed Wire Esophageal Balloon Dilatation Catheters	61
M00556201	NaviPro Hydrophilic Guidewire	3	M00558381	CRE Fixed Wire Esophageal Balloon Dilatation Catheters	61
M00556211	NaviPro Hydrophilic Guidewire	3	M00558390	CRE Wireguided Esophageal / Pyloric Balloon Dilatation Catheters	63
M00556221	NaviPro Hydrophilic Guidewire	3	M00558400	CRE Wireguided Esophageal / Pyloric Balloon Dilatation Catheters	63
M00556231	NaviPro Hydrophilic Guidewire	3	M00558410	CRE Wireguided Esophageal / Pyloric Balloon Dilatation Catheters	63
M00556241	NaviPro Hydrophilic Guidewire	3	M00558420	CRE Wireguided Esophageal / Pyloric Balloon Dilatation Catheters	63
M00556251	NaviPro Hydrophilic Guidewire	3	M00558430	CRE Wireguided Esophageal / Pyloric Balloon Dilatation Catheters	63
M00556461	Jagwire High Performance Guidewire – Straight	2	M00558440	CRE Wireguided Esophageal / Pyloric Balloon Dilatation Catheters	63
M00556481	Stiff Shaft Jagwire Guidewire – Straight	2	M00558450	CRE Wireguided Esophageal / Pyloric / Colonic Balloon Dilatation Catheters	64
M00556491	Stiff Shaft Jagwire Guidewire – Angled	2	M00558460	CRE Wireguided Esophageal / Pyloric / Colonic Balloon Dilatation Catheters	64
M00556511	Jagwire™ High Performance Guidewire – Stiff Shaft – Angled	2	M00558470	CRE Wireguided Esophageal / Pyloric / Colonic Balloon Dilatation Catheters	64
M00556521	Jagwire High Performance Guidewire – Stiff Shaft – Straight	2	M00558480	CRE Wireguided Esophageal / Pyloric / Colonic Balloon Dilatation Catheters	64
M00556531	Jagwire High Performance Guidewire – Stiff Shaft – Angled	2	M00558490	CRE Wireguided Esophageal / Pyloric / Colonic Balloon Dilatation Catheters	64
M00556561	Jagwire High Performance Guidewire – Straight	2	M00558500	CRE Wireguided Esophageal / Pyloric / Colonic Balloon Dilatation Catheters	64
M00556581	Jagwire High Performance Guidewire – Straight	2			
M00556591	Jagwire High Performance Guidewire – Angled	2			
M00556601	Jagwire High Performance Guidewire – Stiff Shaft – Straight	2			
M00556611	Jagwire High Performance Guidewire – Stiff Shaft – Angled	2			
M00556621	Jagwire High Performance Guidewire – Straight	2			
M00556631	Jagwire High Performance Guidewire – Stiff Shaft – Straight	2			
M00556641	Jagwire High Performance Guidewire – Straight	2			
M00556651	Jagwire High Performance Guidewire – Angled	2			

Product Code Index

Product Code	Description	Page #	Product Code	Description	Page #
M00558600	CRE PRO Wireguided Biliary Balloon Dilators CRE PRO Wireguided Esophageal / Pyloric / Biliary Balloon Dilatation Catheters	30 62	M00560150	Injection Gold Probe™ Single-Use Electrohemostasis / Injection Catheters – Standard Plug	49
M00558610	CRE PRO Wireguided Biliary Balloon Dilatation Catheters CRE PRO Wireguided Esophageal / Pyloric / Biliary Balloon Dilatation Catheters	30 62	M00560160	Injection Gold Probe Single-Use Electrohemostasis / Injection Catheters – Standard Plug	49
M00558620	CRE PRO Wireguided Biliary Balloon Dilatation Catheters CRE PRO Wireguided Esophageal / Pyloric / Biliary Balloon Dilatation Catheters	30 62	M00560220	Gold Probe Single-Use Electrohemostasis Catheters – Standard Plug	49
M00558630	CRE PRO Wireguided Biliary Balloon Dilatation Catheters CRE PRO Wireguided Esophageal / Pyloric / Biliary Balloon Dilatation Catheters	30 62	M00560311	Sensation™ Single-Use Medium Stiff Wire Short Throw Snares – Medium Oval	81
M00558640	CRE™ PRO Wireguided Biliary Balloon Dilatation Catheters CRE PRO Wireguided Esophageal / Pyloric / Biliary Balloon Dilatation Catheters	30 62	M00560321	Sensation Single-Use Medium Stiff Wire Short Throw Snares – Small Oval	81
M00558650	CRE PRO Wireguided Biliary Balloon Dilatation Catheters CRE PRO Wireguided Esophageal / Pyloric / Biliary Balloon Dilatation Catheters	30 62	M00560331	Sensation Single-Use Medium Stiff Wire Short Throw Snares – Medium Crescent	81
M00558660	CRE PRO Wireguided Biliary Balloon Dilatation Catheters CRE PRO Wireguided Esophageal / Pyloric / Colonic / Biliary Balloon Dilatation Catheters	30 62	M00561101	Captivator™ COLD Single-Use Snares	78
M00558670	CRE™ PRO Wireguided Biliary Balloon Dilatation Catheters CRE PRO Wireguided Esophageal / Pyloric / Colonic / Biliary Balloon Dilatation Catheters	30 62	M00561102	Captivator COLD Single-Use Snares	78
M00558680	CRE PRO Wireguided Biliary Balloon Dilatation Catheters CRE PRO Wireguided Esophageal / Pyloric / Colonic / Biliary Balloon Dilatation Catheters	30 62	M00561103	Captivator COLD Single-Use Snares	78
M00558690	CRE PRO Wireguided Biliary Balloon Dilatation Catheters CRE PRO Wireguided Esophageal / Pyloric / Colonic / Biliary Balloon Dilatation Catheters	30 62	M00561191	Captivator II Single-Use Snares – Rounded Stiff	79
M00558700	CRE PRO Wireguided Biliary Balloon Dilatation Catheters CRE PRO Wireguided Esophageal / Pyloric / Colonic / Biliary Balloon Dilatation Catheters	30 62	M00561192	Captivator II Single-Use Snares – Rounded Stiff	79
M00558710	CRE PRO Wireguided Biliary Balloon Dilatation Catheters CRE PRO Wireguided Esophageal / Pyloric / Colonic / Biliary Balloon Dilatation Catheters	30 62	M00561193	Captivator II Single-Use Snares – Rounded Stiff	79
M00558731	Expect™ Pulmonary Adaptor	92	M00561221	Captivator II Single-Use Snares – Rounded Stiff	79
M00558860	CRE RX Biliary Balloon Dilatation Catheters	30, 63	M00561222	Captivator II Single-Use Snares – Rounded Stiff	79
M00558870	CRE RX Biliary Balloon Dilatation Catheters	30, 63	M00561223	Captivator II Single-Use Snares – Rounded Stiff	79
M00558880	CRE RX Biliary Balloon Dilatation Catheters	30, 63	M00561231	Captivator II Single-Use Snares – Rounded Stiff	79
M00558890	CRE RX Biliary Balloon Dilatation Catheters	30, 63	M00561232	Captivator II Single-Use Snares – Rounded Stiff	79
M00558900	CRE RX Biliary Balloon Dilatation Catheters	30, 63	M00561233	Captivator II Single-Use Snares – Rounded Stiff	79
M00558910	CRE RX Biliary Balloon Dilatation Catheters	30, 63	M00561241	Captivator II Single-Use Snares – Rounded Stiff	79
M00558920	CRE RX Biliary Balloon Dilatation Catheters	30, 63	M00561242	Captivator II Single-Use Snares – Rounded Stiff	79
M00558930	CRE RX Biliary Balloon Dilatation Catheters	30, 63	M00561243	Captivator II Single-Use Snares – Rounded Stiff	79
M00558940	CRE RX Biliary Balloon Dilatation Catheters	30, 63	M00561250	Active Cords – Fits Olympus™ Brand Generator	13, 82
M00560070	Gold Probe™ Single-Use Electrohemostasis Catheters – Standard Plug	49	M00561270	Active Cord, Fits Endostat™, Endostat II and Endostat III Generators, Bovie™, Valleylab™, Aspen Labs™, and ERBE™ Brand Generators	13, 82
M00560071	Gold Probe Single-Use Electrohemostasis Catheters – Standard Plug	49	M00561291	Captivator II Single-Use Snare – Extra Large Rounded	79
M00560100	Gold Probe Single-Use Electrohemostasis Catheters – Standard Plug	49	M00561311	Captivator Single-Use Snares – Large Oval Medium	79
M00560101	Gold Probe Single-Use Electrohemostasis Catheters – Standard Plug	49	M00561450	Electrosurgical Bipolar Cable Adapter	52
			M00561470	Electrosurgical Bipolar Cable Adapter	52
			M00561480	Electrosurgical Bipolar Cable Adapter	52
			M00561600	Captivator EMR Device for Standard Gastrosopes	78
			M00561601	Captivator EMR Device for Standard Gastrosopes	78
			M00561610	Captivator EMR Device for Large Gastrosopes	78
			M00561611	Captivator EMR Device for Large Gastrosopes	78
			M00561821	Single-Use Rotatable Snares – Small Oval	80
			M00561831	Single-Use Rotatable Snares – Medium Oval	80
			M00562301	Captivator Single-Use Snares – Small Oval	79
			M00562321	Captivator Single-Use Snares – Medium Oval	79
			M00562341	Captivator Single-Use Snares – Medium Hexagonal	79
			M00562371	Captivator Single-Use Snares – Medium Crescent	79
			M00562391	Captivator Single-Use Snares – Large Oval	79
			M00562401	Captiflex™ Single-Use Snares – Medium Oval	81
			M00562402	Captiflex Single-Use Snares – Medium Oval	81

Product Code Index

Product Code	Description	Page #	Product Code	Description	Page #
M00562421	Captiflex Single-Use Snares – Small Oval	81	M00565010	WallFlex™ Duodenal Stent System with Anchor Lock Delivery System	43
M00562422	Captiflex Single-Use Snares – Small Oval	81	M00565020	WallFlex Duodenal Stent System with Anchor Lock Delivery System	43
M00562451	Captivator Single-Use Snares – Small Hexagonal	79	M00565030	WallFlex Duodenal Stent System with Anchor Lock Delivery System	43
M00562471	Captiflex Single-Use Snares – Extra Small Oval	81	M00565040	WallFlex Colonic Stent System with Anchor Lock Delivery System	42
M00562531	Profile™ Single-Use Snares – Extra Small Oval	80	M00565050	WallFlex Colonic Stent System with Anchor Lock Delivery System	42
M00562551	Profile Single-Use Snares – Small Oval	80	M00565060	WallFlex Colonic Stent System with Anchor Lock Delivery System	42
M00562571	Profile™ Single-Use Snares – Medium Oval	80	M00565070	WallFlex Colonic Stent System with Anchor Lock Delivery System	42
M00562651	Sensation™ Single-Use Short Throw Snares – Large Oval / Medium Stiff	81	M00565080	WallFlex Colonic Stent System with Anchor Lock Delivery System	42
M00562652	Sensation Single-Use Short Throw Snares – Large Oval / Medium Stiff	81	M00565090	WallFlex Colonic Stent System with Anchor Lock Delivery System	42
M00562671	Sensation Single-Use Short Throw Snares – Medium Oval / Flexible	81	M00565100	WallFlex Colonic Stent System with Anchor Lock Delivery System	42
M00562672	Sensation Single-Use Short Throw Snares – Medium Oval / Flexible	81	M00565110	WallFlex Colonic Stent System with Anchor Lock Delivery System	42
M00562673	Sensation Single-Use Short Throw Snares – Medium Oval / Flexible	81	M00565120	WallFlex Colonic Stent System with Anchor Lock Delivery System	42
M00562691	Sensation Single-Use Short Throw Snares – Small Oval / Flexible	81	M00565130	WallFlex Colonic Stent System with Anchor Lock Delivery System	42
M00562692	Sensation Single-Use Short Throw Snares – Small Oval / Flexible	81	M00565140	WallFlex Colonic Stent System with Anchor Lock Delivery System	42
M00562693	Sensation Single-Use Short Throw Snares – Small Oval / Flexible	81	M00565150	WallFlex Colonic Stent System with Anchor Lock Delivery System	42
M00562760	EndoVive™ Low Profile Replacement Button	76	M00566001	Rapid Refill Continuous Injection System	13
M00562770	EndoVive Low Profile Replacement Button	76	M00566320	EndoVive Through-the-PEG (TTP) Jejunal Feeding Tube – Bent Tip	77
M00562780	EndoVive Low Profile Replacement Button	76	M00566330	EndoVive Through-the-PEG (TTP) Jejunal Feeding Tube – Pigtail Tip	77
M00562790	EndoVive Low Profile Replacement Button	76	M00566340	EndoVive Through-the-PEG (TTP) Jejunal Feeding Tube – Bent Tip	77
M00562800	EndoVive Low Profile Replacement Button	76	M00566350	EndoVive Through-the-PEG (TTP) Jejunal Feeding Tube – Pigtail Tip	77
M00562820	EndoVive Low Profile Replacement Button	76	M00566461	EndoVive Safety PEG Kit – Pull	73
M00562830	EndoVive Low Profile Replacement Button	76	M00566471	EndoVive Safety PEG Kit – Push	73
M00562840	EndoVive Low Profile Replacement Button	76	M00566481	EndoVive Safety PEG Kit – Pull	73
M00562850	EndoVive Low Profile Replacement Button	76	M00566491	EndoVive Safety PEG Kit – Push	73
M00563010	EndoVive One Step Button™ Low Profile PEG Kit, Pull	74	M00566670	Encore™ 26 Inflation Device	32, 33
M00563020	EndoVive One Step Button Low Profile PEG Kit, Pull	74	M00568201	EndoVive™ Standard PEG Kit – Pull	73
M00563030	EndoVive One Step Button Low Profile PEG Kit, Pull	74	M00568211	EndoVive Standard PEG Kit – Push	73
M00563040	EndoVive One Step Button Low Profile PEG Kit, Pull	74	M00568241	EndoVive Standard PEG Kit – Pull	73
M00563080	EndoVive One Step Button Low Profile PEG Kit, Push	74	M00568251	EndoVive Standard PEG Kit – Push	73
M00563090	EndoVive One Step Button Low Profile PEG Kit, Push	74	M00570340	WallFlex™ Biliary RX Fully Covered Stent System RMV	14
M00563100	EndoVive One Step Button Low Profile PEG Kit, Push	74	M00570350	WallFlex Biliary RX Fully Covered Stent System RMV	14
M00563120	EndoVive One Step Button Low Profile PEG Kit, Pull	74	M00570360	WallFlex Biliary RX Fully Covered Stent System RMV	14
M00563130	EndoVive One Step Button Low Profile PEG Kit, Pull	74	M00570370	WallFlex Biliary RX Fully Covered Stent System RMV	14
M00563140	EndoVive One Step Button Low Profile PEG Kit, Pull	74			
M00563150	EndoVive One Step Button Low Profile PEG Kit, Pull	74			
M00563160	EndoVive One Step Button Low Profile PEG Kit, Pull	74			
M00563180	EndoVive One Step Button Low Profile PEG Kit, Push	74			
M00563190	EndoVive One Step Button Low Profile PEG Kit, Push	74			
M00564101	eXcelon™ Transbronchial Aspiration Needle	93			
M00564111	eXcelon Transbronchial Aspiration Needle	93			
M00564121	eXcelon Transbronchial Aspiration Needle	93			

Product Code Index

Product Code	Description	Page #	Product Code	Description	Page #
M00570380	WallFlex Biliary RX Fully Covered Stent System RMV	14	M00576300	Ultraflex™ Single-Use Uncovered Tracheobronchial Stent System – Distal Release	89
M00570600	WallFlex Biliary RX Uncovered Stent System	15	M00576310	Ultraflex Single-Use Uncovered Tracheobronchial Stent System – Distal Release	89
M00570610	WallFlex Biliary RX Uncovered Stent System	15	M00576320	Ultraflex Single-Use Uncovered Tracheobronchial Stent System – Distal Release	89
M00570620	WallFlex Biliary RX Uncovered Stent System	15	M00576330	Ultraflex Single-Use Uncovered Tracheobronchial Stent System – Distal Release	89
M00570630	WallFlex Biliary RX Uncovered Stent System	15	M00576340	Ultraflex Single-Use Uncovered Tracheobronchial Stent System – Distal Release	89
M00570640	WallFlex Biliary RX Uncovered Stent System	15	M00576350	Ultraflex Single-Use Uncovered Tracheobronchial Stent System – Distal Release	89
M00570650	WallFlex Biliary RX Uncovered Stent System	15	M00576360	Ultraflex Single-Use Uncovered Tracheobronchial Stent System – Distal Release	89
M00570660	WallFlex Biliary RX Uncovered Stent System	15	M00576370	Ultraflex Single-Use Uncovered Tracheobronchial Stent System – Distal Release	89
M00570700	WallFlex Biliary RX Partially Covered Stent System	14	M00576380	Ultraflex Single-Use Uncovered Tracheobronchial Stent System – Distal Release	89
M00570710	WallFlex Biliary RX Partially Covered Stent System	14	M00576410	Ultraflex Single-Use Uncovered Tracheobronchial Stent System – Proximal Release	89
M00570720	WallFlex Biliary RX Partially Covered Stent System	14	M00576420	Ultraflex™ Single-Use Uncovered Tracheobronchial Stent System – Proximal Release	89
M00570730	WallFlex Biliary RX Partially Covered Stent System	14	M00576430	Ultraflex Single-Use Uncovered Tracheobronchial Stent System – Proximal Release	89
M00570740	WallFlex Biliary RX Partially Covered Stent System	14	M00576440	Ultraflex Single-Use Uncovered Tracheobronchial Stent System – Proximal Release	89
M00570890	WallFlex Biliary RX Uncovered Stent System	14	M00576450	Ultraflex Single-Use Uncovered Tracheobronchial Stent System – Proximal Release	89
M00572230	Epic™ Biliary Stent	15	M00576460	Ultraflex Single-Use Uncovered Tracheobronchial Stent System – Proximal Release	89
M00572240	Epic Biliary Stent	15	M00576470	Ultraflex™ Single-Use Uncovered Tracheobronchial Stent System – Proximal Release	89
M00572250	Epic Biliary Stent	15	M00576480	Ultraflex Single-Use Uncovered Tracheobronchial Stent System – Proximal Release	89
M00572260	Epic Biliary Stent	15	M00576490	Ultraflex Single-Use Uncovered Tracheobronchial Stent System – Proximal Release	89
M00572270	Epic Biliary Stent	15	M00576520	Ultraflex Single-Use Partially Covered Tracheobronchial Stent System – Distal Release	90
M00572280	Epic Biliary Stent	15	M00576530	Ultraflex Single-Use Partially Covered Tracheobronchial Stent System – Distal Release	90
M00572290	Epic Biliary Stent	15	M00576540	Ultraflex Single-Use Partially Covered Tracheobronchial Stent System – Distal Release	90
M00572300	Epic Biliary Stent	15	M00576550	Ultraflex Single-Use Partially Covered Tracheobronchial Stent System – Distal Release	90
M00572310	Epic Biliary Stent	15	M00576560	Ultraflex Single-Use Partially Covered Tracheobronchial Stent System – Distal Release	90
M00572320	Epic Biliary Stent	15	M00576570	Ultraflex Single-Use Partially Covered Tracheobronchial Stent System – Distal Release	90
M00572330	Epic Biliary Stent	15	M00576580	Ultraflex Single-Use Partially Covered Tracheobronchial Stent System – Distal Release	90
M00572340	Epic Biliary Stent	15	M00576590	Ultraflex Single-Use Partially Covered Tracheobronchial Stent System – Distal Release	90
M00573000	Jagtome™ RX 49 Sphincterotome (Preloaded with Jagwire™ Guidewire)	6	M00576600	Ultraflex Single-Use Partially Covered Tracheobronchial Stent System – Distal Release	90
M00573010	Jagtome RX 49 Sphincterotome (Preloaded with Jagwire Guidewire)	6			
M00573020	Jagtome RX 49 Sphincterotome (Preloaded with Jagwire Guidewire)	6			
M00573030	Jagtome RX 49 Sphincterotome (Preloaded with Jagwire Guidewire)	6			
M00573040	Jagtome RX 44 Sphincterotome (Preloaded with Jagwire Guidewire)	6			
M00573050	Jagtome RX 44 Sphincterotome (Preloaded with Jagwire Guidewire)	6			
M00573060	Jagtome RX 44 Sphincterotome (Preloaded with Jagwire Guidewire)	6			
M00573070	Jagtome RX 44 Sphincterotome (Preloaded with Jagwire Guidewire)	6			
M00573080	Jagtome RX 39 Sphincterotome (Preloaded with Jagwire Guidewire)	6			
M00573090	Jagtome RX 39 Sphincterotome (Preloaded with Jagwire Guidewire)	6			
M00573100	Jagtome RX 39 Sphincterotome (Preloaded with Jagwire Guidewire)	6			
M00573110	Jagtome RX 39 Sphincterotome (Preloaded with Jagwire Guidewire)	6			

Product Code Index

Product Code	Description	Page #	Product Code	Description	Page #
M00576610	Ultraflex Single-Use Partially Covered Tracheobronchial Stent System – Distal Release	90	M00582080	EndoVive Replacement Gastrostomy Feeding Tubes, Straight Bolster	75
M00576620	Ultraflex Single-Use Partially Covered Tracheobronchial Stent System – Distal Release	90	M00582090	EndoVive Replacement Gastrostomy Feeding Tubes, Straight Bolster	75
M00576630	Ultraflex Single-Use Partially Covered Tracheobronchial Stent System – Distal Release	90	M00582100	EndoVive Replacement Gastrostomy Feeding Tubes, Straight Bolster	75
M00576640	Ultraflex Single-Use Partially Covered Tracheobronchial Stent System – Distal Release	90	M00582110	EndoVive Replacement Gastrostomy Feeding Tubes, Right Angle Bolster	75
M00576650	Ultraflex Single-Use Partially Covered Tracheobronchial Stent System – Distal Release	90	M00582120	EndoVive Replacement Gastrostomy Feeding Tubes, Right Angle Bolster	75
M00576660	Ultraflex Single-Use Partially Covered Tracheobronchial Stent System – Distal Release	90	M00582130	EndoVive Replacement Gastrostomy Feeding Tubes, Right Angle Bolster	75
M00576670	Ultraflex Single-Use Partially Covered Tracheobronchial Stent System – Distal Release	90	M00582140	EndoVive Replacement Gastrostomy Feeding Tubes, Right Angle Bolster	75
M00576680	Ultraflex Single-Use Partially Covered Tracheobronchial Stent System – Distal Release	90	M00582150	EndoVive Replacement Gastrostomy Feeding Tubes, Right Angle Bolster	75
M00576690	Ultraflex Single-Use Partially Covered Tracheobronchial Stent System – Distal Release	90	M00582160	EndoVive™ Replacement Gastrostomy Feeding Tubes, Right Angle Bolster	75
M00580171	EndoVive™ Low Profile Replacement Button Accessories – 18Fr Bolus Feeding Set, Straight Adapter	74,76	M00582170	EndoVive Replacement Gastrostomy Feeding Tubes, Right Angle Bolster	75
M00580181	EndoVive Low Profile Replacement Button Accessories – 18Fr Right Angle Feeding Set, Continuous Adapter	74,76	M00582860	EndoVive Replacement Gastrostomy Feeding Tubes, Straight Bolster	75
M00580231	EndoVive Low Profile Replacement Button Accessories – 24Fr Bolus Feeding Set, Straight Adapter	74,76	M00582870	EndoVive Replacement Gastrostomy Feeding Tubes, Right Angle Bolster	75
M00580241	EndoVive Low Profile Replacement Button Accessories – 24Fr Right Angle Feeding Set, Continuous Adapter	74,76	M00583000	Hydratome™ RX 49 Sphincterotome (Preloaded with Hydra Jagwire™ Guidewire)	5
M00580401	EndoVive Low Profile Replacement Button Accessories – 18Fr Decompression Tube	74,76	M00583010	Hydratome RX 49 Sphincterotome (Preloaded with Hydra Jagwire Guidewire)	5
M00580411	EndoVive Low Profile Replacement Button Accessories – 18Fr Decompression Tube	74,76	M00583020	Hydratome™ RX 49 Sphincterotome (Preloaded with Hydra Jagwire Guidewire)	5
M00580421	EndoVive Low Profile Replacement Button Accessories – 18Fr Decompression Tube	74,76	M00583030	Hydratome RX 49 Sphincterotome (Preloaded with Hydra Jagwire Guidewire)	5
M00580431	EndoVive Low Profile Replacement Button Accessories – 18Fr Decompression Tube	74,76	M00583040	Hydratome RX 44 Sphincterotome (Preloaded with Hydra Jagwire Guidewire)	5
M00580441	EndoVive Low Profile Replacement Button Accessories – 18Fr Decompression Tube	74,76	M00583050	Hydratome RX 44 Sphincterotome (Preloaded with Hydra Jagwire™ Guidewire)	5
M00580461	EndoVive Low Profile Replacement Button Accessories – 24Fr Decompression Tube	74,76	M00583060	Hydratome RX 44 Sphincterotome (Preloaded with Hydra Jagwire Guidewire)	5
M00580471	EndoVive Low Profile Replacement Button Accessories – 24Fr Decompression Tube	74,76	M00583070	Hydratome RX 44 Sphincterotome (Preloaded with Hydra Jagwire Guidewire)	5
M00580481	EndoVive Low Profile Replacement Button Accessories – 24Fr Decompression Tube	74,76	M00583080	TRUEtome™ Jag 39 Cannulating Sphincterotome (Preloaded with Jagwire High Performance Guidewire)	8
M00580491	EndoVive Low Profile Replacement Button Accessories – 24Fr Decompression Tube	74,76	M00583090	TRUEtome Jag 44 Cannulating Sphincterotome (Preloaded with Jagwire High Performance Guidewire)	8
M00580641	EndoVive Initial Placement PEG Accessories – Y-Ports	73	M00583100	TRUEtome Jag 44 Cannulating Sphincterotome (Preloaded with Jagwire High Performance Guidewire)	8
M00580651	EndoVive Initial Placement PEG Accessories – Y-Ports	73	M00583110	TRUEtome Jag 44 Cannulating Sphincterotome (Preloaded with Jagwire High Performance Guidewire)	8
M00582040	EndoVive Replacement Gastrostomy Feeding Tubes, Straight Bolster	75	M00583120	TRUEtome Jag 39 Cannulating Sphincterotome (Preloaded with Jagwire High Performance Guidewire)	8
M00582050	EndoVive Replacement Gastrostomy Feeding Tubes, Straight Bolster	75	M00583130	TRUEtome Jag 44 Cannulating Sphincterotome (Preloaded with Jagwire High Performance Guidewire)	8
M00582060	EndoVive Replacement Gastrostomy Feeding Tubes, Straight Bolster	75	M00583140	TRUEtome Jag 44 Cannulating Sphincterotome (Preloaded with Jagwire High Performance Guidewire)	8
M00582070	EndoVive Replacement Gastrostomy Feeding Tubes, Straight Bolster	75			

Product Code Index

Product Code	Description	Page #	Product Code	Description	Page #
M00583150	TRUetome Jag 44 Cannulating Sphincterotome (Preloaded with Jagwire High Performance Guidewire).....	8		with Jagwire Revolution High Performance Guidewire).....	6
M00583160	TRUetome Hydra 44 Cannulating Sphincterotome (Preloaded with Hydra Jagwire High Performance Guidewire)....	8	M00584270	Jagtome Revolution RX 39 Sphincterotome (Preloaded with Jagwire Revolution High Performance Guidewire).....	6
M00583170	TRUetome Hydra 44 Cannulating Sphincterotome (Preloaded with Hydra Jagwire High Performance Guidewire)....	8	M00584380	Autotome Pro RX 44 Cannulating Sphincterotome	4, 7
M00583180	TRUetome Dreamwire 44 Cannulating Sphincterotome (Preloaded with Hydra Jagwire High Performance Guidewire)....	8	M00584390	Autotome Pro RX 39 Cannulating Sphincterotome	4, 7
M00583190	TRUetome Dreamwire 44 Cannulating Sphincterotome (Preloaded with Dreamwire High Performance Guidewire)..	8	M00584470	Autotome Pro RX 39 25mm Cut Wire, Jag Rev -0.025" x 260cm	4
M00583200	TRUetome Dreamwire 44 Cannulating Sphincterotome (Preloaded with Dreamwire High Performance Guidewire)..	8	M00584480	Autotome Pro RX 39 25mm Cut Wire, Jag Rev -0.025" x 450cm	4
M00583210	TRUetome Dreamwire 44 Cannulating Sphincterotome (Preloaded with Dreamwire High Performance Guidewire)..	8	M005XXXX1	RX Cholangiogram Kit-Preloaded - Autotome™ Sphincterotome - RX Locking Device.....	7
M00583260	TRUetome Revolution RX Cannulating Sphincterotome (Preloaded with Jagwire Revolution High Performance Guidewire).....	8	M005XXXX1	RX Cholangiogram Kits - Autotome or Ultratome™ XL Sphincterotome.....	7
M00583270	TRUetome Revolution RX Cannulating Sphincterotome (Preloaded with Jagwire Revolution High Performance Guidewire).....	8	SBB-119-50	HedgeHog™ Valve Brush.....	84
M00583280	TRUetome Revolution RX Cannulating Sphincterotome (Preloaded with Jagwire Revolution High Performance Guidewire).....	8	SBB-382-50	HedgeHog™ Double Bundle (Double-End Brush + Valve Brush)	84
M00583290	TRUetome Revolution RX Cannulating Sphincterotome (Preloaded with Jagwire Revolution High Performance Guidewire).....	8	SBC-501-100	Seal Single-Use Biopsy Valve	87
M00584000	Dreamtome™ RX 49 Sphincterotome (Preloaded with Dreamwire High Performance Guidewire)..	4	SBD-228-50	HedgeHog Double-End Channel Brush	84
M00584010	Dreamtome RX 49 Sphincterotome (Preloaded with Dreamwire High Performance Guidewire)..	4	SBD-289-50	HedgeHog Dual-End Channel / Valve Brush	84
M00584020	Dreamtome RX 49 Sphincterotome (Preloaded with Dreamwire High Performance Guidewire)..	4	SBD-291-50	HedgeHog Sweeper Channel Brush	84
M00584030	Dreamtome RX 49 Sphincterotome (Preloaded with Dreamwire High Performance Guidewire)..	4	SBS-227-50	HedgeHog Single-End Channel Brush.....	84
M00584040	Dreamtome RX 44 Sphincterotome (Preloaded with Dreamwire High Performance Guidewire)..	4	SBT-114-100	Blox™ Endoscopic Bite Block with Elastic Cloth Strap (54 FR) 84	
M00584050	Dreamtome RX 44 Sphincterotome (Preloaded with Dreamwire High Performance Guidewire)..	4	SBT-321-100	Blox Endoscopic Bite Block with Elastic Cloth Strap (54 FR) (w/o Dental Retention).....	84
M00584060	Dreamtome RX 44 Sphincterotome (Preloaded with Dreamwire High Performance Guidewire)..	4	SBT-546-100	Blox Endoscopic Bite Block with Elastic Cloth Strap (60 FR)..	84
M00584070	Dreamtome RX 44 Sphincterotome (Preloaded with Dreamwire High Performance Guidewire)..	4	SCT-350-10	Hydra™ Water Bottle Cap.....	85
M00584120	TRUetome 39 Sphincterotome.....	9	SCT-351-10	Hydra Water Bottle Cap	85
M00584150	TRUetome 49 Sphincterotome	9	SEE-220-4	Pure™ Enzymatic Detergent - Spearmint Scent.....	84
M00584160	TRUetome 49 Sphincterotome	9	SEE-573-4	Pure Enzymatic Detergent - Fragrance Free.....	84
M00584170	TRUetome 44 Sphincterotome	9	SES-240-50	Koala Cleaning Sponge plus Pure Enzymatic with Ecobowl..	86
M00584180	TRUetome 44 Sphincterotome	9	SIT-355-15	Hydra Irrigation Tubing (Compatible with ERBE, Medivators Pumps)	85
M00584190	TRUetome 39 Sphincterotome.....	9	SIT-361-100	Hydra Disposable Auxiliary Water Jet Connector.....	85
M00584240	Jagtome™ Revolution RX 39 Sphincterotome (Preloaded with Jagwire™ Revolution High Performance Guidewire).....	6	SIT-576-15	Hydra Irrigation Tubing (Compatible with Olympus Pumps)..	85
M00584250	Jagtome Revolution RX 39 Sphincterotome (Preloaded with Jagwire Revolution High Performance Guidewire).....	6	SLT-394-100	Endoglide™+ Sterile Bacteriostatic Lubricating Gel	85
M00584260	Jagtome Revolution RX 39 Sphincterotome (Preloaded		SLT-395-50	Endoglide+ Sterile Bacteriostatic Lubricating Gel.....	85
			SLT-612-50	Sterile Lubricating Jelly (56.7g/2oz)	85
			SPX-017-25	CinchPad™ Endoscope Transport Pad.....	86
			SSB-210-50	Koala™ Cleaning Sponge.....	86
			STE-297-50	TrapEase™ Single Chamber Polyp Trap	87
			STE-298-50	TrapEase Quad Chamber Polyp Trap.....	87
			SUV-617-50	Orca™ Sterile Single-Use Air/Water & Suction Valves.....	87
			SUV-628-50	OrcaPod™ 3 - Orca Sterile Single-Use Air/Water, Suction, and Seal Biopsy Valves.....	87
			SUV-629-50	OrcaPod 4 - Orca Sterile Single-Use Air/Water, Suction, and Seal Biospy Valves with WaterJet Connector	87
			SVT-089-100	Suction Tubing, NS, 3/16" x 6'.....	86
			SVT-090-100	Suction Tubing, NS, 3/16" x 10'	86
			SVT-095-100	Suction Tubing, NS, 3/16" x 12'	86

Product Code Index

Product Code	Description	Page #
SVT-143-100	Suction Tubing, 1/4" X 6'	86
SVT-144-60	Suction Tubing, NS 1/4" x 10'	86
SVT-145-50	Suction Tubing, NS, 1/4" x 12'	86
M00505500	X-Tack™ Helical Tacking System Gastric Length	53
M00505510	X-Tack™ Helical Tacking System Colonic Length	53



Terms & Conditions

▶ Begins on Page	112
------------------------	-----

► Certain Terms and Conditions

ORDERING INFORMATION

All orders should be placed directly with Boston Scientific Endoscopy Customer Service by mail, telephone, fax or Electronic Data Interchange (EDI).

Boston Scientific Endoscopy
500 Commander Shea Blvd.
Quincy, MA 02171
(888) 272-1001 Phone
(888) 272-9444 Fax
(877) 272-3340 EDI

Please contact EDI if interested in ordering your endoscopy products via the internet.

Please note that the above address is our mailing address only.

Customer Service is available between the hours of 8:30 am and 9:30 pm (Eastern Standard Time) weekdays excluding national holidays. Our toll-free fax number, (888) 272-9444, is available at all times. In addition, technical and emergency service is available 24 hours a day, 7 days a week, call (888) 272-1001 for further instructions.

Standing Orders

Boston Scientific Endoscopy accepts standing orders on all products. This convenience provides you with scheduled shipments using a single purchase order. Contact the Customer Service Database Department at (888) 325-1060 for details.

Terms

Terms are Net 30 Days. All shipments are F.O.B. Quincy, Massachusetts. Prices are subject to change without notice.

Returned Goods

Permission to return merchandise is required for all returns and, except as provided herein, may be withheld in the sole discretion of Boston Scientific Endoscopy. This authorization must be requested by calling or writing:

Customer Service
Boston Scientific Endoscopy
500 Commander Shea Blvd.
Quincy, MA 02171
(800) 862-1284

The request for authorization must include:

- Reason for the return – “Ordered in Error,” “Shipped in Error,” etc.
- Catalog number, size, quantity, lot number
- Purchase order number, Boston Scientific Endoscopy invoice number and date of invoice

All merchandise returned to Boston Scientific Endoscopy must be accompanied by a copy of the packing slip or invoice enclosed with the original shipment. The Returned Goods Authorization (RGA) number must be clearly marked on the shipping container. Merchandise returned without an RGA number will not be accepted or considered as returned product.

Merchandise that will not be accepted for return:

- Expired product or products with less than 6 months shelf life
- Merchandise manufactured as SPECIALS or CUSTOM
- Merchandise in unsaleable condition (opened, damaged, tampered, etc.)
- Merchandise not listed in this Price List or any Supplement
- Merchandise sterilized or used by customer
- Merchandise that is not packaged properly for shipping when returned
- Incomplete kits or boxes (unless defective)
- Unauthorized returns

► Certain Terms and Conditions

Returned Goods (continued)

Allowance Schedule for Authorized Returns:

Allowance Schedule for Capital Equipment:

- Capital Equipment processed in error by Boston Scientific Endoscopy will receive full credit if returned in saleable condition
- Capital Equipment cannot be returned once the customer has taken title of the equipment

Allowance Schedule for Metal and Polyflex™ Stents and Alair™ Bronchial Thermoplasty Products:

- Merchandise processed in error by Boston Scientific Endoscopy will receive full credit if returned in saleable condition
- Merchandise returned within 30 days of invoice date in saleable condition will receive 100% credit
- Merchandise returned from 31 days to 90 days in saleable condition will receive full credit less a 30% restocking charge
- Merchandise returned from 91 days to 150 days in saleable condition will receive full credit less a 50% restocking fee
- Merchandise returned past 150 days will not receive any credit

Allowance Schedule for All Other Products:

- Merchandise processed in error by Boston Scientific Endoscopy will receive full credit if returned in saleable condition
- Other merchandise returned within 30 days of invoice date in saleable condition will receive full credit less a 15% restocking charge
- Merchandise returned past 31 days in saleable condition will receive full credit less a 40% restocking charge provided there is at least 6 months left on the expiration date

Pricing and Specification Changes

As we are continually introducing products and improving our existing products, this Price List does not purport to be complete, and the equipment supplied may not agree in all details with the description and specifications shown in the catalog and / or price list. All product offerings, prices and specifications are subject to change without notice.

Notice

Indications, contraindications and instructions for use, as well as product warranty information, if applicable, can be found in the product labeling supplied with each device. Caution: Federal law restricts this device to sale by or on the order of a physician.

Warning Re: Single-Use Devices

Products marked as “single-use” are for single use only. Do not reuse, reprocess or resterilize single-use products. Reuse, reprocessing or resterilization may compromise the structural integrity of the device and / or lead to device failure which in turn may result in patient injury, illness or death. Reuse, reprocessing or resterilization may also create a risk of contamination of the device and / or cause patient infection or cross-infection, including, but not limited to, the transmission of infectious disease(s) from one patient to another. Contamination of the device may lead to injury, illness or death of the patient. **BSC assumes no liability with respect to single-use devices reused, reprocessed or resterilized and makes no warranties, express or implied, including, but not limited to, any implied warranties of merchantability or fitness for a particular purpose, with respect to any such instrument.**

©2026 Boston Scientific Corporation or its Affiliates. All rights reserved.

INDICATIONS FOR USE

WallFlex Biliary RX Stent System, WallFlex Biliary PLUS RX Stent System indicated for use in the palliative treatment of biliary strictures produced by malignant neoplasms and relief of malignant biliary obstruction prior to surgery.

Warning: The safety and effectiveness of this device for use in vascular system has not been established.

The WallFlex™ Biliary RX Fully Covered Stent System RMV is indicated for use in the palliative treatment of biliary strictures produced by malignant neoplasms, relief of malignant biliary obstruction prior to surgery and for indwell up to 12 months in the treatment of benign biliary strictures secondary to chronic pancreatitis.

LIMITATIONS

The sale, distribution, and use of the device are restricted to prescription use in accordance with 21 CFR §801.109.

Contraindications:

- The WallFlex Biliary RX Fully Covered Stent System RMV should not be placed in strictures that cannot be dilated enough to pass the delivery system, in a perforated duct, or in very small intrahepatic ducts.
- The WallFlex Biliary RX Fully Covered Stent System RMV should not be used in patients for whom endoscopic techniques are contraindicated.

Warnings:

- The safety and effectiveness of the stent for benign stricture treatment has not been established for indwell periods exceeding 12 months.
- The WallFlex Biliary RX Fully Covered Stent System RMV is for single-use only.
- The safety and effectiveness of the WallFlex Biliary RX Fully Covered Stent System RMV for use in the vascular system has not been established.
- Clinical Study was not able to demonstrate that the use of this device is safe and effective in the treatment of benign biliary post liver transplantation anastomotic strictures and of benign biliary post abdominal surgery strictures.
- Testing of overlapped stents has not been conducted.
- The stent contains nickel, which may cause an allergic reaction in individuals with nickel sensitivity.
- The safety and effectiveness of this device for use in vascular system has not been established.

PLEASE REFER TO THE LABELING FOR A MORE COMPLETE LIST OF WARNINGS, PRECAUTIONS AND CONTRAINDICATIONS.

INDICATIONS FOR USE

The ORBERA Intra gastric Balloon System is indicated for use as an adjunct to weight reduction for adults with obesity with Body Mass Index (BMI) of ≥ 30 and ≤ 40 kg/m² and is to be used in conjunction with a long-term supervised diet and behavior modification. Maximum placement period is 6 months.

Contraindications:

- Prior surgery involving the esophagus, stomach, and duodenum or bariatric surgery.
- A structural abnormality in the esophagus or pharynx such as a stricture or diverticulum that could impede passage of the delivery catheter and/or an endoscope.
- Achalasia, symptoms suggestive of delayed gastric emptying, or presence of any other severe motility disorder that that may pose a safety risk during placement or removal of the device.
- Any other medical condition that would not permit elective endoscopy such as poor general health or history and/or symptoms of severe renal, hepatic, cardiac, and/or pulmonary disease.
- Patients who are unable or unwilling to take prescribed proton pump inhibitor medication for the duration of the device implant.
- Patients receiving aspirin, anti-inflammatory agents, anticoagulants, or other gastric irritants, not under medical supervision.

Warnings:

- Each patient must be monitored closely during the entire term of treatment in order to detect the development of possible adverse events. Each patient should be instructed regarding symptoms of deflation (i.e. collapse), gastrointestinal obstruction, ulceration, gastric and esophageal perforation, acute pancreatitis, IGB inflation after placement (i.e. spontaneous hyperinflation) and other adverse events which might occur and should be advised to contact his/her physician immediately upon the onset of such symptoms. Patients need to be evaluated and the device removed at or within 6 months of placement.
- Patients with an IGB that present with severe abdominal pain that have a negative endoscopy and x-ray may additionally require a CT scan to definitively rule out a perforation.
- Patients must be advised that the IGB is intended to be placed for 6 months maximally, at which point removal is required. Longer periods of IGB placement increase the risk of IGB deflation (a reduction in size of the device due to loss of saline) which can lead to intestinal obstruction and risk for death.
- The risk of intestinal obstruction may be higher in patients who have a dysmotility disorder, or who have had prior abdominal or gynecological surgery, radiation therapy, and/or active inflammatory bowel disease, so this should be considered in assessing the risk of the procedure. Bowel obstructions can result in death.
- Acute pancreatitis has been reported as a result of injury to the pancreas by the IGB. Patients experiencing any symptoms of acute pancreatitis should be counseled to seek immediate care. Symptoms may include nausea, vomiting, abdominal or back pain, either steady or cyclic. If abdominal pain is steady, pancreatitis may have developed.
- Hyperinflation of the IGB often warrants its early removal to prevent serious complications such as gastric outlet obstruction and contact ulceration.
- Endoscopic removal of the IGB must be completed in the presence of an empty stomach. Patients should be on a liquid diet for 72 hours and NPO (i.e. nothing by mouth) for a minimum of 12 hours prior to removal. If food is found in the stomach upon endoscopic examination, then measures (aspiration of stomach contents, endotracheal intubation, or delay of procedure) must be taken to protect the airway. The risk of aspiration of gastric contents into the patient's lungs represents a serious risk which can result in death. Intra gastric balloons have been shown to cause delayed gastric emptying which may increase the time typically needed to ensure an empty stomach prior to endoscopic procedures.



Section Table of Contents



Prev Page

113

Next Page



Home



▶ Customer Ordering Information

Universal Product Number

Radial Jaw™ 4 Single-Use Jumbo Biopsy Forceps

Order Number	GTIN	Description
M005 13343	08714729761891	Radial Jaw 4 Jumbo Forceps
M005 13353	08714729761907	Radial Jaw 4 Jumbo Forceps
M005 13363	08714729761914	Radial Jaw 4 Jumbo Forceps
M005 13373	08714729761938	Radial Jaw 4 Jumbo Forceps
M005 13361	08714729648871	Radial Jaw 4 Jumbo Forceps
M005 13371	08714729648895	Radial Jaw 4 Jumbo Forceps
M005 13362	08714729648888	Radial Jaw 4 Jumbo Forceps

Bold type
is old order
number

For customer convenience, the Boston Scientific Endoscopy ordering system accepts the UPN (Universal Product Number) e.g., **M00513362** found on product labeling as well as Boston Scientific's old 4 digit order numbers e.g., **1336**.

Please use either one of these numbers when placing an order via phone, fax, internet, or Electronic Data Interchange (EDI).

For those customers who scan product today, Boston Scientific is moving to the GS1 GTIN barcode and labeling standards as part of our ongoing commitment to improve supply chain efficiency. For more information go to the website: www.bostonscientific.com/GS1.

Boston Scientific Endoscopy Customer Service Representatives will be happy to help you with any questions. We are eager to make the ordering procedure as simple and efficient as possible.



**Magnetic Resonance
Conditional¹**

¹Product with this symbol may be used in Magnetic Resonance environment according to the conditions described in Directions for Use.

All trademarks are the property of their respective owners.

**Boston
Scientific**

Advancing science for life™

Boston Scientific Corporation
300 Boston Scientific Way
Marlborough, MA 01752-1234
www.bostonscientific.com

Ordering Information
1.888.272.1001

©2026 Boston Scientific Corporation
or its affiliates. All rights reserved.

ENDO - 1201902-AH