

USER'S MANUAL

**EMBLEM™ S-ICD**

Electrode Delivery System

Model 4712

**CAUTION:** Federal law (USA) restricts this device to sale by or on the order of a physician trained or experienced in device implant and follow-up procedures.



## Table of Contents

Description.....	1
Trademark Information.....	1
Related Information.....	1
Indications for Use.....	1
Contraindications.....	1
Warnings.....	2
Precautions.....	4
Potential Adverse Events.....	5
Pre-Implant Information.....	7
Surgical Preparation.....	7
Items Included in Package.....	8
Implantation.....	9
Overview.....	9
Implant the EMBLEM S-ICD Subcutaneous Electrode.....	13
Connect the Subcutaneous Electrode to the Pulse Generator.....	31
EMBLEM S-ICD Electrode Delivery System Diagram.....	31
EMBLEM S-ICD Electrode Delivery System Specifications.....	32
Definitions of Package Label Symbols.....	33
Warranty Disclaimer.....	35

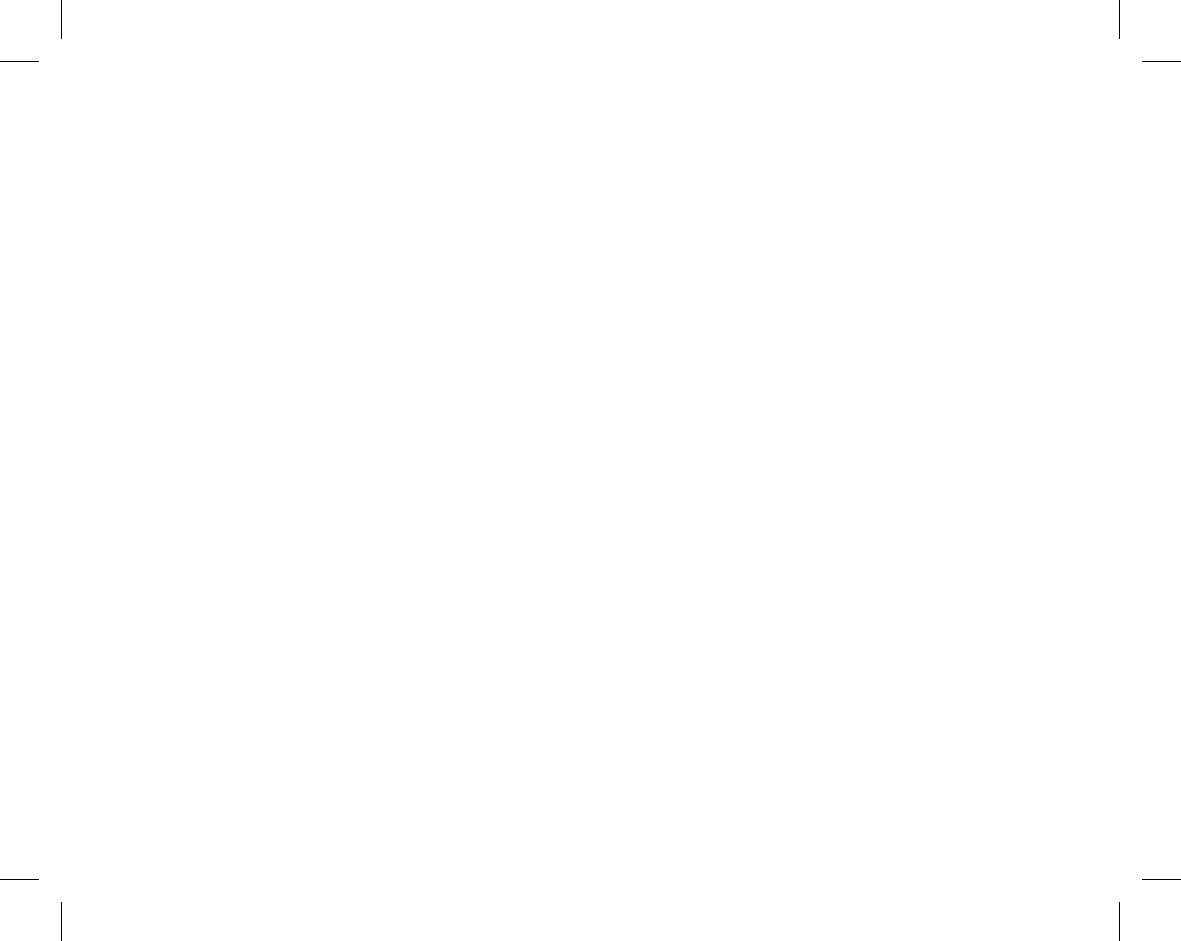

## **DESCRIPTION**

The EMBLEM S-ICD Electrode Delivery System (the "EDS") is a component of the Boston Scientific S-ICD System, which is prescribed for patients when cardiac arrhythmia management is warranted. The EDS consists of two tunneling tools with pre-loaded introducer sheaths and is used to create subcutaneous tunnels to facilitate implantation of the EMBLEM S-ICD Subcutaneous Electrode. The EDS is also compatible with S-ICD Electrode models 3401 and 3501.

## **TRADEMARK INFORMATION**

The following are trademarks of Boston Scientific Corporation or its affiliates: EMBLEM.

## **RELATED INFORMATION**

Instructions in this manual should be used in conjunction with other resource material, including the applicable S-ICD pulse generator user's manual and subcutaneous electrode user's manual.

A summary of the S-ICD System Clinical Investigation, including observed adverse events, can be obtained by contacting Boston Scientific using the information on the back cover.

## **INTENDED AUDIENCE**

This literature is intended for use by professionals trained or experienced in device implant and/or follow-up procedures.

## **INDICATIONS FOR USE**

The S-ICD System is intended to provide defibrillation therapy for the treatment of life-threatening ventricular tachyarrhythmias in patients who do not have symptomatic bradycardia, incessant ventricular tachycardia, or spontaneous, frequently recurring ventricular tachycardia that is reliably terminated with antitachycardia pacing.

## **CONTRAINDICATIONS**

Unipolar stimulation and impedance-based features are contraindicated for use with the S-ICD System.

## WARNINGS

**NOTE:** Before using the S-ICD System, read and follow all warnings and precautions provided in the applicable S-ICD pulse generator user's manual.

### General

- **Labeling knowledge.** Read this manual thoroughly before using the S-ICD System to avoid damage to the pulse generator and/or subcutaneous electrode. Such damage can result in patient injury or death.
- **For single patient use only.** Do not reuse, reprocess, or resterilize. Reuse, reprocessing, or resterilization may compromise the structural integrity of the device and/or lead to device failure which, in turn, may result in patient injury, illness, or death. Reuse, reprocessing, or resterilization may also create a risk of contamination of the device and/or cause patient infection or cross-infection, including, but not limited to, the transmission of infectious disease(s) from one patient to another. Contamination of the device may lead to injury, illness, or death of the patient.
- **Component compatibility.** All Boston Scientific S-ICD implantable components are designed for use with the Boston Scientific or Cameron Health S-ICD System only. Connection of any S-ICD System components to a non-compatible component has not been tested and could result in failure to deliver life-saving defibrillation therapy.
- **Backup defibrillation protection.** Always have external defibrillation equipment and medical personnel skilled in CPR available during implant and follow-up testing. If not terminated in a timely fashion, an induced ventricular tachyarrhythmia can result in the patient's death.

### Handling

- **Proper handling.** Handle the components of the S-ICD System with care at all times and maintain proper sterile technique. Failure to do so may lead to injury, illness, or death of the patient. Use care when tunneling to avoid injury to the implanter.

- **Do not damage components.** Do not modify, cut, kink, crush, stretch, or otherwise damage any component of the S-ICD System. Impairment to the S-ICD System may result in an inappropriate shock or failure to deliver therapy to the patient.
- **Handling the subcutaneous electrode.** Use caution handling the subcutaneous electrode connector. Do not directly contact the connector with any surgical instruments such as forceps, hemostats, or clamps. This could damage the connector. A damaged connector may result in compromised sealing integrity, possibly leading to compromised sensing, loss of therapy, or inappropriate therapy.

### Implantation

- **Arm positioning.** Attention is required to placement of the arm ipsilateral to the device implant to avoid injury of the ulnar nerve and brachial plexus while the patient is in the supine position during device implantation and before VF induction or shock delivery. The patient should be positioned with the arm abducted to an angle of no more than 60° with the hand in a supinated (palm up) position during the implant phase of the procedure. Securing the arm to an arm board is standard practice to maintain positioning of the arm during device implantation. Do not strap the arm too tightly during defibrillation testing. Elevation of the torso through use of a wedge may also add stress to the shoulder joint and should be avoided during defibrillation testing.
- **System migration.** Use appropriate anchoring techniques as described in the implant procedure to prevent S-ICD System dislodgement and/or migration. Dislodgement and/or migration of the S-ICD System may result in an inappropriate shock or failure to deliver therapy to the patient.
- **Do not implant in MRI site Zone III.** Implant of the system cannot be performed in an MRI site Zone III (and higher) as defined by the American College of Radiology Guidance Document for Safe MR Practices<sup>1</sup>. Some of the accessories used with pulse generators and electrodes, including the torque wrench and electrode implant tools, are not MR Conditional and should not be brought into the MRI scanner room, the control room, or the MRI site Zone III or IV areas.

---

1. Kanal E, et al., American Journal of Roentgenology 188:1447-74, 2007

## PRECAUTIONS

### Clinical Considerations

- **Pediatric use.** The S-ICD System has not been evaluated for pediatric use.
- **Available therapies.** The S-ICD System does not provide long-term bradycardia pacing, cardiac resynchronization therapy (CRT), or antitachycardia pacing (ATP).

### Sterilization and Storage

- **If package is damaged.** The pouch and its contents are sterilized with ethylene oxide gas. When the EDS is received, it is sterile provided the sterile pouch is intact. If the packaging is wet, punctured, opened, or otherwise damaged, return the EDS to Boston Scientific.
- **Use by date.** Use the EDS before or on the USE BY date on the package label because this date reflects a validated shelf life. For example, if the date is January 1, do not use on or after January 2.
- **Storage temperature.** The recommended storage temperature range is -18°C to +55°C (0°F to +131°F).

### Implantation

- **Creating the subcutaneous tunnels.** Use Boston Scientific tools and accessories designed for use in implanting the subcutaneous electrode to create the subcutaneous tunnels when implanting and positioning the subcutaneous electrode. Avoid tunneling close to any other subcutaneously implanted medical devices or components, for example, an implantable insulin pump, drug pump, sternal wiring from previous sternotomy, or ventricular assist device.
- **Superior tunnel length.** Ensure the superior tunnel is long enough to accommodate the portion of the electrode from the distal tip to the suture sleeve without buckling or curving of the defibrillation coil. Buckling or curvature of the defibrillation coil within the superior tunnel could lead to compromised sensing and/or therapy delivery. After insertion of the electrode into the superior tunnel, X-ray or fluoroscopy may be used to confirm that no buckling or curvature is observed.



- **Suture location.** Suture only those areas indicated in the implant instructions.
- **Do not suture directly over subcutaneous electrode body.** Do not suture directly over the subcutaneous electrode body, as this may cause structural damage. Use the suture sleeve to prevent subcutaneous electrode movement.
- **Sternal wires.** When implanting the S-ICD system in a patient with sternal wires, ensure that there is no contact between the sternal wires and the distal and proximal sense electrodes (for example, by using fluoroscopy). Compromised sensing can occur if metal-to-metal contact occurs between a sense electrode and a sternal wire. If necessary, re-tunnel the electrode to ensure sufficient separation between the sense electrodes and the sternal wires.

For precautions related to hospital or other medical environments, refer to the applicable S-ICD pulse generator user's manual.

### **POTENTIAL ADVERSE EVENTS**

Potential adverse events related to implantation of the S-ICD System may include, but are not limited to, the following:

- Acceleration/induction of atrial or ventricular arrhythmia
- Adverse reaction to induction testing
- Allergic/adverse reaction to system or medication
- Bleeding
- Conductor fracture
- Cyst formation
- Death
- Delayed therapy delivery

- Discomfort or prolonged healing of incision
- Electrode deformation and/or breakage
- Electrode insulation failure
- Erosion/extrusion
- Failure to deliver therapy
- Fever
- Hematoma/seroma
- Hemothorax
- Improper electrode connection to the device
- Inability to communicate with the device
- Inability to defibrillate or pace
- Inappropriate post-shock pacing
- Inappropriate shock delivery
- Infection
- Injury to or pain in upper extremity, including clavicle, shoulder, and arm
- Keloid formation
- Migration or dislodgement
- Muscle/nerve stimulation
- Nerve damage
- Pneumothorax

- Post-shock/post-pace discomfort
- Premature battery depletion
- Random component failures
- Stroke
- Subcutaneous emphysema
- Surgical revision or replacement of the system
- Syncope
- Tissue redness, irritation, numbness or necrosis

If any adverse events occur, invasive corrective action and/or S-ICD System modification or removal may be required.

Patients who receive an S-ICD System may develop psychological disorders that include, but are not limited to, the following:

- Depression/anxiety
- Fear of device malfunction
- Fear of shocks
- Phantom shocks

## **PRE-IMPLANT INFORMATION**

### **Surgical Preparation**

Consider the following prior to the implantation procedure:

The S-ICD System is designed to be positioned using anatomical landmarks. However, it is recommended to review a pre-implant chest x-ray in order to confirm that a patient does not have notably atypical anatomy (e.g., dextrocardia). Consider marking the intended position of the implanted system components and/or incisions prior to the procedure, utilizing anatomical landmarks or fluoroscopy as a guide. Additionally, if deviations from the implant instructions are required to accommodate for physical body size or habitus, it is recommended that a pre-implant chest x-ray has been reviewed.

**WARNING:** Attention is required to placement of the arm ipsilateral to the device implant to avoid injury of the ulnar nerve and brachial plexus while the patient is in the supine position during device implantation and before VF induction or shock delivery. The patient should be positioned with the arm abducted to an angle of no more than 60° with the hand in a supinated (palm up) position during the implant phase of the procedure. Securing the arm to an arm board is standard practice to maintain positioning of the arm during device implantation. Do not strap the arm too tightly during defibrillation testing. Elevation of the torso through use of a wedge may also add stress to the shoulder joint and should be avoided during defibrillation testing.

#### **Items Included in Package**

Store in a clean, dry area. The following pre-sterilized items are included in the EDS packaging:

- Lateral Tunneling Tool
- Lateral Sheath (pre-loaded)
- Superior Tunneling Tool
- Superior Sheath (pre-loaded)

Additionally, product literature is included.

## IMPLANTATION

### Overview

This section presents the information necessary for implanting the EMBLEM S-ICD Subcutaneous Electrode (Model 3401 or 3501) using the EMBLEM S-ICD Electrode Delivery System (the “EDS”).

**WARNING:** All Boston Scientific S-ICD implantable components are designed for use with the Boston Scientific or Cameron Health S-ICD System only. Connection of any S-ICD System components to a non-compatible component has not been tested and could result in failure to deliver life-saving defibrillation therapy.

**WARNING:** Implant of the system cannot be performed in an MRI site Zone III (and higher) as defined by the American College of Radiology Guidance Document for Safe MR Practices<sup>2</sup>. Some of the accessories used with pulse generators and electrodes, including the torque wrench and electrode implant tools, are not MR Conditional and should not be brought into the MRI scanner room, the control room, or the MRI site Zone III or IV areas.

**NOTE:** *If the electrode terminal will not be connected to a pulse generator at the time of electrode implantation, you must cap the electrode terminal before closing the pocket incision. The lead cap is designed specifically for this purpose. Place a suture around the lead cap to keep it in place.*

The pulse generator and subcutaneous electrode are typically implanted subcutaneously in the left thoracic region. The electrode implant tools are used to create the subcutaneous tunnels in which the electrode is inserted. The defibrillation coil must be positioned parallel to the sternum, in close proximity to or in contact with the deep fascia, below adipose tissue, approximately 1-2 cm from the sternal midline (Figure 1 Placement of the S-ICD System (Model 3501 Electrode shown) on page 10 and Figure 2 Subcutaneous Tissue Layers on page 11).

---

2. Kanal E, et al., American Journal of Roentgenology 188:1447-74, 2007

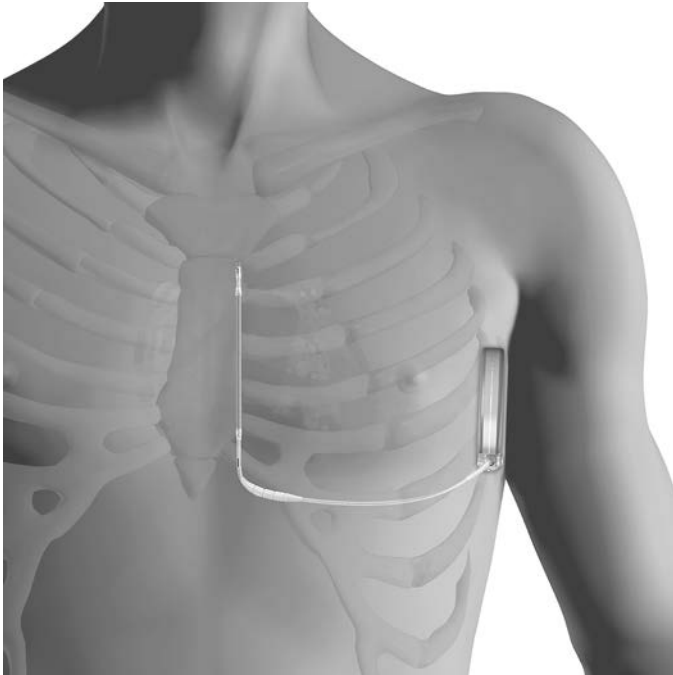

**Figure 1. Placement of the S-ICD System (Model 3501 Electrode shown)**

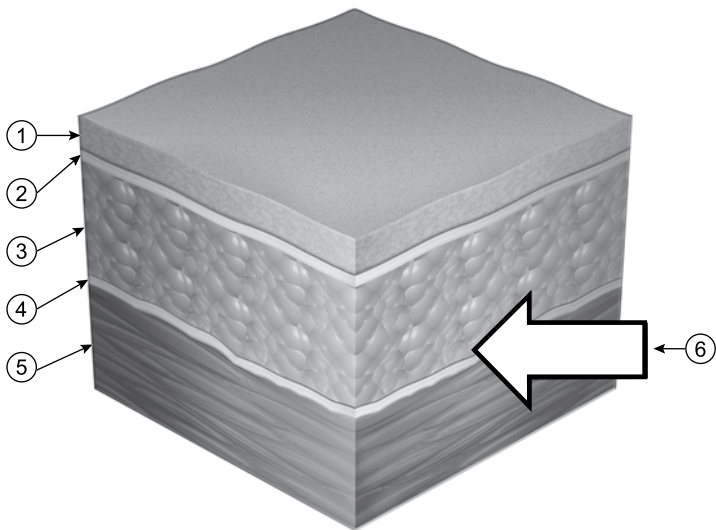

[1] Skin, [2] Hypodermal layer, [3] Adipose tissue, [4] Deep fascia, [5] Sub-fascial tissue (muscle or bone), [6] Correct location for subcutaneous tunnels and the S-ICD Subcutaneous Electrode

**Figure 2. Subcutaneous Tissue Layers**

Placement of the pulse generator and electrode can be achieved using various techniques. To ensure optimal placement of the subcutaneous electrode at the fascial plane, physician preference and patient assessment should be considered when choosing the implant method.

Care should be taken to position both the electrode and device directly on the fascia without underlying adipose tissue. High shocking electrode impedance may be associated with adipose tissue under the coil of the electrode, which may require repositioning of the electrode so that it is on the fascia.

In order to maximize the heart mass between the pulse generator and electrode, while maintaining acceptable sensing parameters, transthoracic defibrillation is achieved through the positioning of an anterior electrode and a device in the mid-axillary line or posterior axillary line.

In case of failure to convert VT/VF without adequate safety margin, either during defibrillation testing or later spontaneous ambulatory episode(s), the physician should review the position of both the electrode and device by use of anatomical landmarks or X-ray/fluoroscopy. A more posterior device location may reduce the defibrillation threshold.

Depending on patient body habitus and anatomy, the physician may choose to position the device between the serratus anterior muscle and the latissimus dorsi muscle. Device fixation to the musculature is needed to secure its position, ensure performance, and to minimize wound complications.

Good tissue contact with the electrode and pulse generator is important to optimize sensing and therapy delivery. Use standard surgical techniques to obtain good tissue contact. For example, keep the tissue moist and flushed with sterile saline, expel any residual air out through the incisions prior to closing and, when closing the skin, take care not to introduce air into the subcutaneous tissue.

A pocket for the pulse generator must be created prior to implanting the subcutaneous electrode. The pocket incision is utilized during the electrode implant. Refer to the applicable S-ICD pulse generator user's manual for information on creating the device pocket.



### Implant the EMBLEM S-ICD Subcutaneous Electrode

The following detailed instructions describe two techniques for implanting the electrode: the two-incision technique and the three-incision technique. Alternate surgical approaches could be considered if system placement requirements can be achieved. The physician determines which tools and surgical technique are used to implant and position the electrode based on the patient's anatomical features. It is recommended that physicians be experienced in the three-incision technique before performing the two-incision technique.

In addition to the incision(s) described below, the pocket incision is utilized when implanting the electrode.

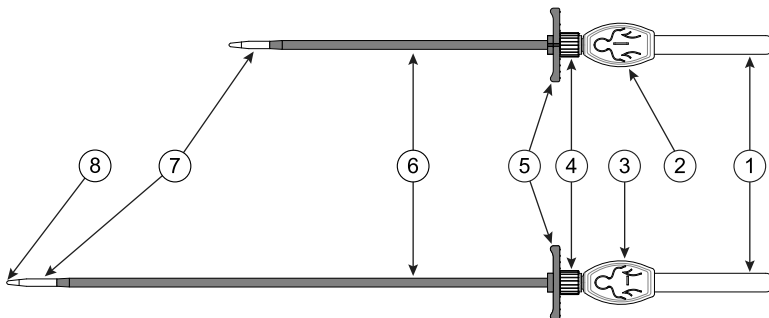

[1] Handle, [2] Picture marking for Superior Tunneling Tool, [3] Picture marking for Lateral Tunneling Tool, [4] Locking Collar, [5] Hub, [6] Pre-loaded Sheath, [7] Distal Tip, [8] Suture hole

**Figure 3. Implant tools**

#### **METHOD 1: TWO-INCISION TECHNIQUE (ANCHORING ELECTRODE AT XIPHOID INCISION ONLY)**

This method of implanting the S-ICD subcutaneous electrode includes the pocket incision and an incision for the electrode at the xiphoid process. It utilizes two tunneling tools of different lengths, both with pre-loaded sheaths that are used to facilitate pushing the electrode through the subcutaneous tunnels. The electrode is anchored to the fascia at one location only, the xiphoid incision.

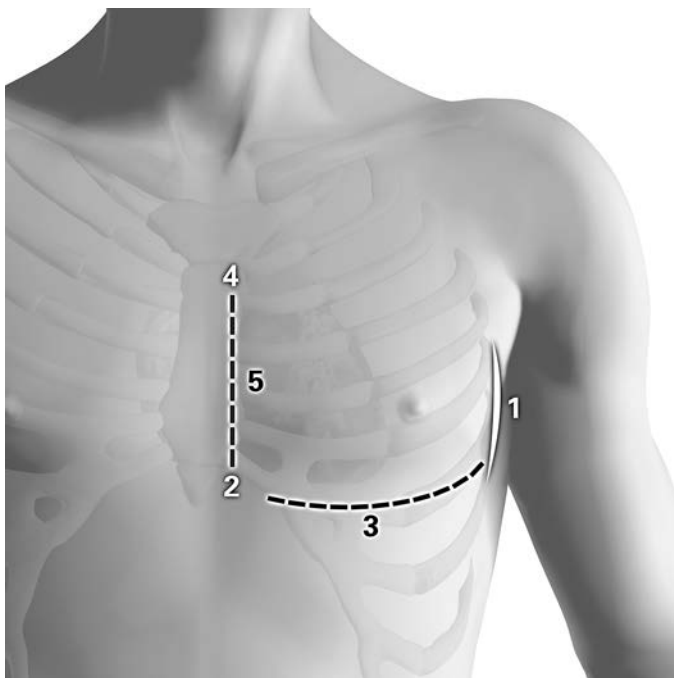

[1] Pocket incision, [2] Xiphoid incision, [3] Lateral tunnel, [4] Superior position or incision, [5] Superior tunnel

**Figure 4. Electrode Implant Schematic**

### ***Lateral Tunnel***

1. Make a small, 2 cm horizontal incision at the xiphoid process (xiphoid incision). The size and orientation may vary at the physician's discretion based on the patient's body habitus.  
**NOTE:** *If desired, in order to facilitate attachment of the suture sleeve to the fascia following electrode placement, two suture ties to the fascia can be placed at the xiphoid incision prior to continuing.*  
**NOTE:** *Ensure that the sutures are securely fastened to fascia by gently tugging on the sutures.*
2. Using the lateral (longer) tunneling tool, verify that the locking collar is securely fastened to the pre-loaded sheath.  
**NOTE:** *Over-rotation of the locking collar will release the sheath from the tunneling handle.*
3. Insert the distal tip of the tunneling tool, with pre-loaded sheath, at the xiphoid incision and tunnel laterally until the distal tip emerges at the pocket incision (Figure 5 Lateral Tunnel on page 17).

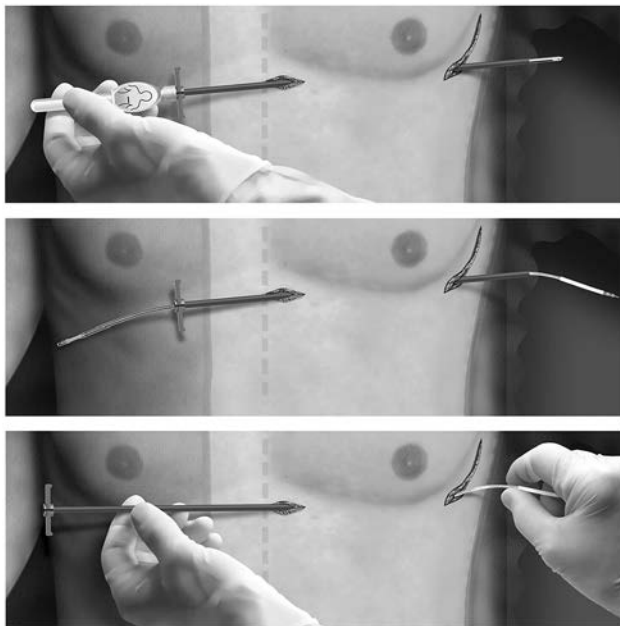

[Top] Creating the lateral tunnel, [Middle] Passing the electrode from the pocket to the xiphoid incision through the sheath, [Bottom] Removing the sheath, leaving the electrode in place

**Figure 5. Lateral Tunnel**

**CAUTION:** Use Boston Scientific tools and accessories designed for use in implanting the subcutaneous electrode to create the subcutaneous tunnels when implanting and positioning the subcutaneous electrode. Avoid tunneling close to any other subcutaneously implanted medical devices or components, for example, an implantable insulin pump, drug pump, sternal wiring from previous sternotomy, or ventricular assist device.

4. Disengage the locking collar and remove the tunneling tool from the sheath while applying forward pressure to the hub of the sheath to stabilize it within the tunnel (Figure 5 Lateral Tunnel on page 17).
5. Starting from the distal end of the sheath at the pocket incision, push the distal tip of the electrode through the sheath until the entire defibrillation coil has passed through the sheath and emerged at the xiphoid incision (Figure 5 Lateral Tunnel on page 17).
6. Hold the proximal end of the electrode at the pocket to stabilize it and remove the sheath by pulling it out through the xiphoid incision (Figure 5 Lateral Tunnel on page 17).
7. Identify the intended position of the distal tip of the electrode, at a point approximately 14 cm superior to the xiphoid incision (superior position (Figure 4 Electrode Implant Schematic on page 15)). The length of the superior tunnel must accommodate the portion of the subcutaneous electrode from the proximal sensing electrode to the distal tip of the electrode body. If the exposed portion of the electrode body is placed on the skin to make this measurement, take tissue depth into account to avoid underestimating the necessary length of the tunnel.

#### ***Anchoring the Electrode at the Xiphoid Incision***

The two subcutaneous electrode models compatible with the EDS have different features for anchoring to the deep fascia. Follow the instructions below that correspond to the model being implanted.

8. **If using S-ICD Subcutaneous Electrode Model 3501**, a suture sleeve is permanently affixed (integrated) to the electrode body. Secure the integrated suture sleeve to the deep fascia with 2-0 silk or similar non-absorbable suture material, using at least two of the four suture grooves. The integrated suture sleeve may be anchored in a horizontal, vertical, or curved orientation (Figure 1 Placement of the S-ICD System (Model 3501 Electrode shown) on page 10).

**OPTIONAL:** If the accessory slit suture sleeve is needed in addition to the integrated suture sleeve, attach it to the electrode body as follows: Place the suture sleeve over the electrode shaft, making sure not to cover the integrated suture sleeve, sensing electrodes, or defibrillation coil. Using the preformed grooves, bind the suture sleeve to the subcutaneous electrode shaft using 2-0 silk or similar non-absorbable suture material. After the suture sleeve is attached to the electrode body, check that it is stable by grasping the suture sleeve with fingers and trying to slide it along the subcutaneous electrode body in either direction. Secure the accessory suture sleeve to the deep fascia with 2-0 silk or similar non-absorbable suture material. The accessory suture sleeve may be anchored in a horizontal, vertical, or angled orientation.

**If using S-ICD Subcutaneous Electrode Model 3401**, place a suture sleeve over the subcutaneous electrode shaft 1 cm below the proximal sensing electrode. Using the preformed grooves, bind the suture sleeve to the subcutaneous electrode shaft using 2-0 silk or similar non-absorbable suture material, making sure not to cover the proximal sensing electrode. After the suture sleeve is attached to the electrode body, check that it is stable by grasping the suture sleeve with fingers and trying to slide it along the subcutaneous electrode body in either direction. Secure the suture sleeve to the deep fascia with 2-0 silk or similar non-absorbable suture material. The suture sleeve may be anchored in a horizontal, vertical, or angled orientation.

**WARNING:** Use appropriate anchoring techniques as described in the implant procedure to prevent S-ICD System dislodgement and/or migration. Dislodgement and/or migration of the S-ICD System may result in an inappropriate shock or failure to deliver therapy to the patient.

**CAUTION:** Do not suture directly over the subcutaneous electrode body, as this may cause structural damage. Use the suture sleeve to prevent subcutaneous electrode movement.

**CAUTION:** Suture only those areas indicated in the implant instructions.

**NOTE:** *Anchoring the subcutaneous electrode to the fascia at the xiphoid incision may be completed either before or after positioning the electrode in the superior tunnel per physician preference.*

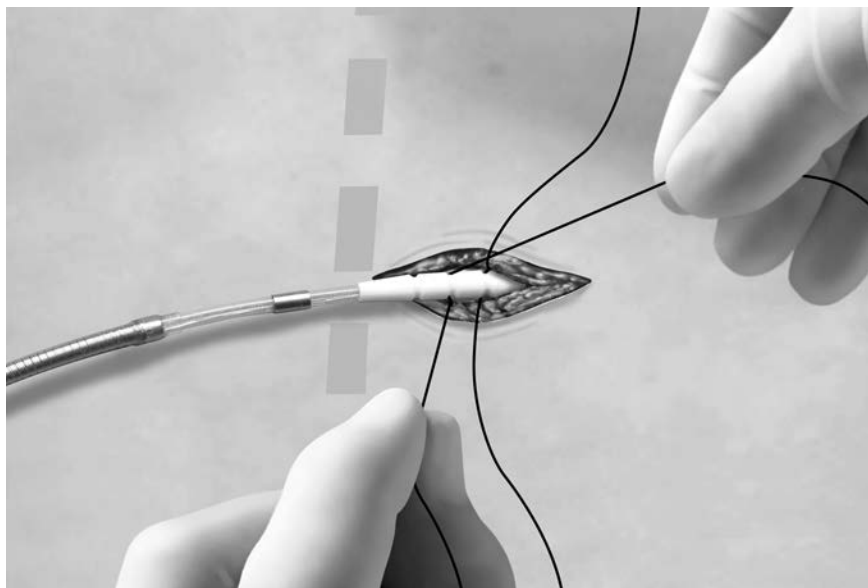

**Figure 6. Anchoring Subcutaneous Electrode at Xiphoid Incision**



### ***Superior Tunnel***

9. Using the superior (shorter) tunneling tool, verify the locking collar is securely fastened to the pre-loaded sheath.

**NOTE:** *Over-rotation of the locking collar will release the sheath from the tunneling handle.*

**CAUTION:** Ensure the superior tunnel is long enough to accommodate the portion of the electrode from the distal tip to the suture sleeve without buckling or curving of the defibrillation coil. Buckling or curvature of the defibrillation coil within the superior tunnel could lead to compromised sensing and/or therapy delivery. After insertion of the electrode into the superior tunnel, X-ray or fluoroscopy may be used to confirm that no buckling or curvature is observed.

10. Insert the distal tip of the tunneling tool into the xiphoid incision between the adipose and fascial plane and tunnel subcutaneously towards the superior position, in parallel to the sternal midline, staying below adipose tissue and as close to the deep fascia as possible (Figure 7 Superior Tunnel on page 22). Palpate the skin to locate the distal end of the tunneling tool. It should match the desired location for the distal tip of the electrode as identified in step 7.

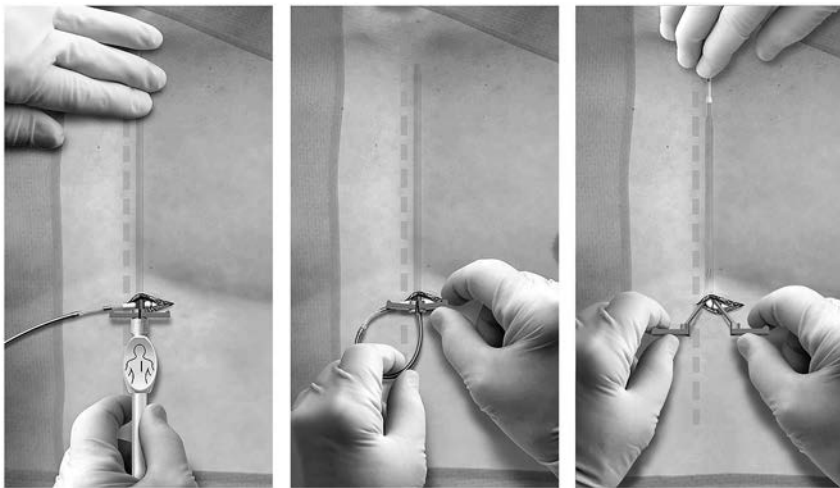

[Left] Creating the superior tunnel, [Middle] Passing the electrode into the sheath after the tunneling tool has been removed, [Right] Peeling the sheath to remove it from the tunnel, while stabilizing the electrode, leaving the electrode in place. The dotted line represents the sternal midline.

**Figure 7. Superior Tunnel**

11. Disengage the sheath from the locking collar by turning the collar counter-clockwise. Remove the tunneling tool from the sheath while applying forward pressure to the hub of the sheath to stabilize it in the tunnel.
12. Crack the hub of the sheath.
13. Starting at the xiphoid incision, advance the distal tip of the electrode through the sheath until the distal sensing electrode reaches the superior position. Palpate the electrode tip to confirm it is correctly positioned (Figure 7 Superior Tunnel on page 22).
14. Stabilize the electrode at the xiphoid incision and/or at the tip to ensure that it remains in position during sheath removal. Peel sheath to remove (Figure 7 Superior Tunnel on page 22).
15. To dispose of the implant tools, return the used product to the original package, then dispose in a biohazard container.
16. To avoid air entrapment and ensure good tissue contact with the implanted subcutaneous electrode, flush all incisions with sterile saline solution and apply firm pressure along the electrode to expel any residual air out through the incisions prior to closing. Consider using fluoroscopy to check the electrode position prior to closure.

#### **METHOD 2: THREE-INCISION TECHNIQUE (ANCHORING ELECTRODE AT XIPHOID AND SUPERIOR INCISIONS)**

This method of implanting the S-ICD subcutaneous electrode includes the pocket incision plus two additional incisions for the electrode at both the xiphoid process and superior position. The longer tool is used to pull the electrode through the subcutaneous tunnels. The electrode is anchored to the deep fascia at two locations, the xiphoid and superior incisions.

##### ***Lateral Tunnel***

1. Make a small, 2 cm horizontal incision at the xiphoid process (xiphoid incision). The size and orientation may vary at the physician's discretion based on the patient's body habitus.

**NOTE:** *If desired, in order to facilitate attachment of the suture sleeve to the fascia following electrode placement, two suture ties to the fascia can be placed at the xiphoid incision prior to continuing.*

**NOTE:** *Ensure that the sutures are securely fastened to fascia by gently tugging on the sutures.*

2. The pre-loaded sheath may be used or removed according to physician preference. Use of the sheath is described in Method 1, step 2. To remove the sheath, turn the locking collar on the tunneling tool counter-clockwise until it disengages from the sheath.
3. Insert the distal tip of the lateral (longer) tunneling tool at the xiphoid incision and tunnel laterally until the distal tip emerges at the pocket incision.

**CAUTION:** Use Boston Scientific tools and accessories designed for use in implanting the subcutaneous electrode to create the subcutaneous tunnels when implanting and positioning the subcutaneous electrode. Avoid tunneling close to any other subcutaneously implanted medical devices or components, for example, an implantable insulin pump, drug pump, sternal wiring from previous sternotomy, or ventricular assist device.

4. Using conventional suture material, tie the anchoring hole at the distal end of the subcutaneous electrode to the suture hole at the distal end of the tunneling tool, creating a long 15-16 cm loop (Figure 8 Connecting the Electrode to the Lateral Tunneling Tool on page 25).



**Figure 8. Connecting the Electrode to the Lateral Tunneling Tool**

5. With the subcutaneous electrode attached, carefully pull the tunneling tool back through the tunnel to the xiphoid incision until the proximal sensing electrode emerges.
6. **If using S-ICD Subcutaneous Electrode Model 3501**, a suture sleeve is permanently affixed (integrated) to the electrode body.

**OPTIONAL:** If the accessory slit suture sleeve is needed in addition to the integrated suture sleeve, attach it to the electrode body as follows: Place the suture sleeve over the electrode shaft, making sure not to

cover the integrated suture sleeve, sensing electrodes, or defibrillation coil. Using the preformed grooves, bind the suture sleeve to the subcutaneous electrode shaft using 2-0 silk or similar non-absorbable suture material. After the suture sleeve is attached to the electrode body, check that it is stable by grasping the suture sleeve with fingers and trying to slide it along the subcutaneous electrode body in either direction.

**If using S-ICD Subcutaneous Electrode Model 3401**, place a suture sleeve over the subcutaneous electrode shaft 1 cm below the proximal sensing electrode. Using the preformed grooves, bind the suture sleeve to the subcutaneous electrode shaft using 2-0 silk or similar non-absorbable suture material, making sure not to cover the proximal sensing electrode. After the suture sleeve is attached to the electrode body, check that it is stable by grasping the suture sleeve with fingers and trying to slide it along the subcutaneous electrode body in either direction.

**NOTE:** *The subcutaneous electrode may be anchored to the fascia either before or after creating the superior tunnel at the physician's discretion. For instructions on anchoring at the xiphoid incision, see Anchoring the Electrode at the Xiphoid Incision later in this section.*

### **Superior Tunnel**

**NOTE:** *The length of the superior sheath is not optimized for the three-incision technique, as the distal tip of the electrode may not protrude from the end of the sheath.*

7. Identify the intended position of the superior incision, at a point approximately 14 cm superior to the xiphoid incision (Figure 4 Electrode Implant Schematic on page 15). The length of the superior tunnel must accommodate the portion of the subcutaneous electrode from the proximal sensing electrode to the distal tip of the electrode body. If the exposed portion of the electrode body is placed on the skin to make this measurement, take tissue depth into account to avoid underestimating the necessary length of the tunnel.
8. Make the superior incision. Pre-place one or two fascial sutures in superior incision. Use a non-absorbable suture material of appropriate size for long-term retention. Apply gentle traction to ensure adequate tissue fixation. Retain the needle on the suture for later use in passing through the electrode anchoring hole.

9. Insert the distal tip of the lateral (longer) tunneling tool with the electrode still attached into the xiphoid incision between the adipose and fascial plane and tunnel subcutaneously towards the superior incision, staying below adipose tissue and as close to the deep fascia as possible (Figure 9 Tunneling to Superior Incision on page 28).

**CAUTION:** Ensure the superior tunnel is long enough to accommodate the portion of the electrode from the distal tip to the suture sleeve without buckling or curving of the defibrillation coil. Buckling or curvature of the defibrillation coil within the superior tunnel could lead to compromised sensing and/or therapy delivery. After insertion of the electrode into the superior tunnel, X-ray or fluoroscopy may be used to confirm that no buckling or curvature is observed.



**Figure 9. Tunneling to Superior Incision**

10. Once the distal tip of the tunneling tool emerges from the superior incision, disconnect and retain the suture loop from the distal tip of the tunneling tool. Secure the ends of the suture with a surgical clamp. Remove the tunneling tool.
11. Using the secured suture loop at the superior incision, carefully pull the suture and subcutaneous electrode through the tunnel until the anchoring hole emerges. The subcutaneous electrode should be parallel to the sternal midline with the defibrillation coil beneath any adipose tissue and in close proximity to the deep fascia.
12. Cut and discard the suture material.



### ***Anchoring the Electrode at the Xiphoid Incision***

13. At the xiphoid incision, anchor the subcutaneous electrode to the fascia using 2-0 silk or similar non-absorbable suture material.

**If using S-ICD Subcutaneous Electrode Model 3501**, use at least two of the four suture grooves when anchoring the electrode to the fascia. The integrated suture sleeve may be anchored in a horizontal, vertical, or curved orientation.

**If using S-ICD Subcutaneous Electrode Model 3401**, the suture sleeve(s) may be anchored in a horizontal, vertical, or angled orientation.

**WARNING:** Use appropriate anchoring techniques as described in the implant procedure to prevent S-ICD System dislodgement and/or migration. Dislodgement and/or migration of the S-ICD System may result in an inappropriate shock or failure to deliver therapy to the patient.

**CAUTION:** Do not suture directly over the subcutaneous electrode body, as this may cause structural damage. Use the suture sleeve to prevent subcutaneous electrode movement.

**CAUTION:** Suture only those areas indicated in the implant instructions.

**NOTE:** *Ensure that the suture is securely fastened to fascia by gently tugging on the suture prior to tying to the suture sleeve and subcutaneous electrode.*

14. At the superior incision, secure the anchoring hole at the distal end of the electrode to the fascia using the pre-placed sutures from step 8 (Figure 10 Anchoring the Distal Tip of the Subcutaneous Electrode on page 30).



**Figure 10. Anchoring the Distal Tip of the Subcutaneous Electrode**

**NOTE:** *Ensure that the suture is securely fastened to fascia by gently tugging on the suture prior to tying to the subcutaneous electrode anchoring hole.*

15. Gently tug the subcutaneous electrode at the superior incision to ensure the anchoring hole is secured to the fascia.
16. To dispose of the Electrode Delivery System, return the used products to the original package, then dispose in a biohazard container.
17. To avoid air entrapment and ensure good tissue contact with the implanted subcutaneous electrode, flush all incisions with sterile saline solution and apply firm pressure along the electrode to expel any residual air out through the incisions prior to closing. Consider using fluoroscopy to check the electrode position prior to closure.

### Connect the Subcutaneous Electrode to the Pulse Generator

For information on connecting the subcutaneous electrode to the pulse generator, as well as information about setup of the pulse generator and defibrillation testing, refer to the applicable S-ICD pulse generator user's manual. Additional information on post-implant follow-up and explant of the system can also be found in the applicable S-ICD pulse generator user's manual.

### EMBLEM S-ICD ELECTRODE DELIVERY SYSTEM DIAGRAM

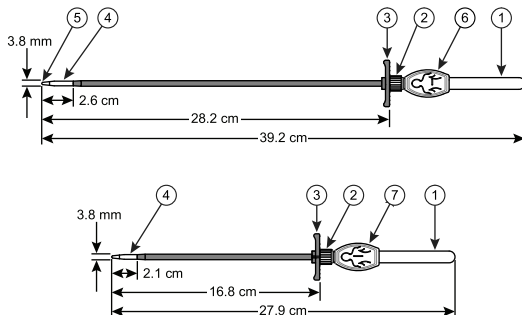

[1] Handle, [2] Locking Collar, [3] Hub, [4] Distal Tip, [5] Suture hole, [6] Picture marking for Lateral Tunneling Tool, [7] Picture marking for Superior Tunneling Tool

**Figure 11. Model 4712 dimensions**

## EMBLEM S-ICD ELECTRODE DELIVERY SYSTEM SPECIFICATIONS

**Table 1. Specifications (Nominal)**

<b>Component</b>	<b>Specifications</b>
Tunneling Tools Materials	<ul style="list-style-type: none"><li>• Acrylonitrile-butadiene-styrene (ABS)</li><li>• Stainless steel</li><li>• Polypropylene</li></ul>
Sheaths (pre-loaded) Materials	<ul style="list-style-type: none"><li>• Polytetrafluoroethylene (PTFE)</li><li>• Polymethylpentene (TPX™)<sup>a</sup></li></ul>
Lateral Tunneling Tool Length	39.2 cm
Lateral Sheath Length	25.7 cm
Superior Tunneling Tool Length	27.9 cm
Superior Sheath Length	14.8 cm
Lateral and Superior Tunneling Tools Tip Diameter	3.78 mm

**Table 1. Specifications (Nominal)** (continued)



Component	Specifications
Sheath Size: Sheath Tip Inner Diameter	3.84 mm (11 Fr)
Transportation, Handling, and Storage Temperature Range	-18°C to +55°C (0°F to +131°F)

a. TPX is a trademark of Mitsui Chemicals America, Inc.







#### DEFINITIONS OF PACKAGE LABEL SYMBOLS

The following symbols may be used on packaging and labeling.





**Table 2. Packaging Symbols**

Symbol	Description
	Sterilized using ethylene oxide
	Date of manufacture
	Authorized Representative in the European Community

**Table 2. Packaging Symbols (continued)**

<b>Symbol</b>	<b>Description</b>
	Use by
	Lot number
	Reference number
	Temperature limitation
	Open here
	Consult instructions for use on this website: <a href="http://www.bostonscientific-elabeling.com">www.bostonscientific-elabeling.com</a>

**Table 2. Packaging Symbols (continued)**

<b>Symbol</b>	<b>Description</b>
	Do not resterilize
	Do not reuse
	Do not use if package is damaged
	Manufacturer

**WARRANTY DISCLAIMER**

Except as otherwise provided herein, Boston Scientific disclaims all express and implied warranties for this product, including without limitation any implied warranties of merchantability or fitness for a particular purpose. Boston Scientific's obligations under any warranty provided herein shall be limited strictly to replacement of the product. Buyer assumes all risk of loss or damages arising from use of this product.











# Boston Scientific

Boston Scientific Corporation  
4100 Hamline Avenue North  
St. Paul, MN 55112-5798 USA

[www.bostonscientific.com](http://www.bostonscientific.com)

1.800.CARDIAC (227.3422)  
+1.651.582.4000

© 2017 Boston Scientific Corporation or its affiliates.  
All rights reserved.

360244-001 EN US 2017-08

