

PHYSICIAN'S TECHNICAL MANUAL

**AUTOGEN™ EL ICD,
DYNAGEN™ EL ICD,
DYNAGEN™ MINI ICD,
INOGEN™ EL ICD,
INOGEN™ MINI ICD,
ORIGEN™ EL ICD,
ORIGEN™ MINI ICD,
INCEPTA™ ICD,
ENERGEN™ ICD,
PUNCTUA™ ICD,
TELIGEN™ 100 ICD**

CAUTION: Federal law (USA) restricts this device to sale by or on the order of a physician trained or experienced in device implant and follow-up procedures.

IMPLANTABLE CARDIOVERTER DEFIBRILLATOR

Model D160, D161, D162, D163, D150, D151, D152, D153, D020, D021, D022, D023, D140, D141, D142, D143, D010, D011, D012, D013, D050, D051, D052, D053, D000, D001, D002, D003, E160, E161, E162, E163, E140, E141, E142, E143, E050, E051, E052, E053, E102, E110

Table of Contents

Additional Information	1
Device Description	1
Related Information.....	3
Indications and Usage.....	4
Contraindications	4
Warnings	5
Precautions.....	7
Supplemental Precautionary Information.....	19
Post-Therapy Pulse Generator Follow Up	19
Transcutaneous Electrical Nerve Stimulation (TENS)	20
Electrocautery and Radio Frequency (RF) Ablation	21
Ionizing Radiation	22
Elevated Pressures.....	23
Potential Adverse Events	25
Mechanical Specifications	27
Items Included in Package	34
Symbols on Packaging.....	35
Characteristics as Shipped.....	39
X-Ray Identifier	41
Federal Communications Commission (FCC).....	42
Pulse Generator Longevity	43
Warranty Information.....	51
Product Reliability	52
Patient Counseling Information	52
Patient Handbook	53
Lead Connections	54

Implanting the Pulse Generator	59
Check Equipment.....	59
Interrogate and Check the Pulse Generator.....	59
Implant the Lead System.....	60
Take Baseline Measurements	61
Form the Implantation Pocket.....	64
Connect the Leads to the Pulse Generator	65
Evaluate Lead Signals	69
Program the Pulse Generator.....	71
Test for Ability to Convert Ventricular Fibrillation and Inducible Arrhythmias	74
Tachyarrhythmia Programming Considerations	77
Implant the Pulse Generator.....	79
Complete and Return the Implantation Form	80
Bidirectional Torque Wrench.....	80
Follow Up Testing.....	82
Explantation	84

ADDITIONAL INFORMATION

For additional reference information, go to www.bostonscientific-elabeling.com.

DEVICE DESCRIPTION

This manual contains information about the AUTOGEN, DYNAGEN, INOGEN, ORIGEN, INCEPTA, ENERGEN, PUNCTUA, and TELIGEN families of implantable cardioverter defibrillators (ICDs), which contain the following types of pulse generators (specific models are listed in "Mechanical Specifications" on page 27):

- VR—single-chamber ICD combining ventricular tachyarrhythmia therapy with ventricular pacing and sensing
- DR—dual-chamber ICD combining ventricular tachyarrhythmia therapy with ventricular and atrial pacing and sensing

NOTE: *This manual may contain information for model numbers that are not currently approved for sale in all geographies. For a complete list of model numbers approved in your geography, consult with your local sales representative. Some model numbers may contain fewer features; for those devices, disregard information about unavailable features.*

Therapies

These pulse generators have a small, thin, physiologic shape that minimizes pocket size and may minimize device migration. They provide a variety of therapies, including:

- Ventricular tachyarrhythmia therapy, which is used to treat rhythms associated with sudden cardiac death (SCD) such as VT and VF
- Bradycardia pacing, including adaptive rate pacing, to detect and treat bradyarrhythmias and to provide cardiac rate support after defibrillation therapy

Cardioversion/defibrillation therapies include:

- A range of low- and high-energy shocks using a biphasic waveform

- The choice of multiple shock vectors:
 - Distal shock electrode to proximal shock electrode and pulse generator case (TRIAD electrode system)
 - Distal shock electrode to proximal shock electrode (RV Coil to RA Coil)
 - Distal shock electrode to pulse generator case (RV Coil to Can)

Leads

The pulse generator has independently programmable outputs and accepts one or more of the following leads, depending on the model:

- One IS-1¹ atrial lead
- One DF-1/IS-1² cardioversion/defibrillation lead
- One DF4-LLHH or DF4-LLHO³ multipolar connector cardioversion/defibrillation lead

Leads with either a GDT-LLHH/LLHO or DF4-LLHH/LLHO label are equivalent and are compatible with a device containing either a GDT-LLHH or DF4-LLHH port.

The pulse generator and the leads constitute the implantable portion of the pulse generator system.

PRM System

These pulse generators can be used with the ZOOM LATITUDE Programming System, which is the external portion of the pulse generator system and includes:

- Model 3120 Programmer/Recorder/Monitor (PRM)
- Model 3140 ZOOM Wireless Transmitter

1. IS-1 refers to the international standard ISO 5841-3:2013.
2. DF-1 refers to the international standard ISO 11318:2002.
3. DF4 refers to the international standard ISO 27186:2010.

- Model 2868 ZOOMVIEW Software Application
- Model 6577 Accessory Telemetry Wand

You can use the PRM system to do the following:

- Interrogate the pulse generator
- Program the pulse generator to provide a variety of therapy options
- Access the pulse generator's diagnostic features
- Perform noninvasive diagnostic testing
- Access therapy history data
- Store a 12 second trace of the ECG/EGM display from any screen
- Access an interactive Demonstration Mode or Patient Data Mode without the presence of a pulse generator
- Print patient data including pulse generator therapy options and therapy history data
- Save patient data

You can program the pulse generator using two methods: automatically using Indications-Based Programming (IBP) or manually.

RELATED INFORMATION

Refer to the lead's instruction manual for implant information, general warnings and precautions, indications, contraindications, and technical specifications. Read this material carefully for implant procedure instructions specific to the chosen lead configurations.

Refer to the PRM system Operator's Manual or ZOOM Wireless Transmitter Reference Guide for specific information about the PRM or ZOOM Wireless Transmitter such as setup, maintenance, and handling.

Refer to these pulse generators' Reference Guide for additional reference information such as using the PRM software, tachyarrhythmia detection and therapy, pacing therapy, sensing, and diagnostics.

LATITUDE NXT is a remote monitoring system that provides pulse generator data for clinicians. All pulse generators described in this manual are designed to be LATITUDE NXT enabled; availability varies by region.

- Physicians/Clinicians—LATITUDE NXT enables you to periodically monitor both patient and device status remotely and automatically. The LATITUDE NXT system provides patient data that can be used as part of the clinical evaluation of the patient.
- Patients—A key component of the system is the LATITUDE Communicator, an easy-to-use, in-home monitoring device. The Communicator automatically reads implanted device data from a compatible Boston Scientific pulse generator at times scheduled by the physician. The Communicator sends this data to the LATITUDE NXT secure server. The LATITUDE NXT server displays the patient data on the LATITUDE NXT Web site, which is readily accessible over the Internet to authorized physicians and clinicians.

Refer to the LATITUDE NXT Clinician Manual for more information.

INTENDED AUDIENCE

This literature is intended for use by professionals trained or experienced in device implant and/or follow-up procedures.

INDICATIONS AND USAGE

Boston Scientific implantable cardioverter defibrillators (ICDs) are intended to provide ventricular antitachycardia pacing (ATP) and ventricular defibrillation for automated treatment of life-threatening ventricular arrhythmias.

CONTRAINDICATIONS

These Boston Scientific pulse generators are contraindicated for the following patients:

- Patients whose ventricular tachyarrhythmias may have reversible cause, such as:
 - Digitalis intoxication

- Electrolyte imbalance
- Hypoxia
- Sepsis
- Patients whose ventricular tachyarrhythmias have a transient cause, such as:
 - Acute myocardial infarction (MI)
 - Electrocutation
 - Drowning
- Patients who have a unipolar pacemaker

WARNINGS

General

- **Labeling knowledge.** Read this manual thoroughly before implantation to avoid damage to the pulse generator and/or lead. Such damage can result in patient injury or death.
- **For single patient use only.** Do not reuse, reprocess, or resterilize. Reuse, reprocessing, or resterilization may compromise the structural integrity of the device and/or lead to device failure which, in turn, may result in patient injury, illness, or death. Reuse, reprocessing, or resterilization may also create a risk of contamination of the device and/or cause patient infection or cross-infection, including, but not limited to, the transmission of infectious disease(s) from one patient to another. Contamination of the device may lead to injury, illness, or death of the patient.
- **Backup defibrillation protection.** Always have external defibrillation equipment available during implant and electrophysiologic testing. If not terminated in a timely fashion, an induced ventricular tachyarrhythmia can result in the patient's death.
- **Resuscitation availability.** Ensure that an external defibrillator and medical personnel skilled in CPR are present during post-implant device testing should the patient require external rescue.

- **Separate pulse generator.** Do not use this pulse generator with another pulse generator. This combination could cause pulse generator interaction, resulting in patient injury or a lack of therapy delivery.

Handling

- **Avoid shock during handling.** Program the pulse generator Tachy Mode(s) to Off during implant, explant, or postmortem procedures to avoid inadvertent high voltage shocks.
- **Do not kink leads.** Do not kink, twist, or braid the lead with other leads as doing so could cause lead insulation abrasion damage or conductor damage.
- **Handling the lead without Connector Tool.** For leads that require the use of a Connector Tool, use caution handling the lead terminal when the Connector Tool is not present on the lead. Do not directly contact the lead terminal with any surgical instruments or electrical connections such as PSA (alligator) clips, ECG connections, forceps, hemostats, and clamps. This could damage the lead terminal, possibly compromising the sealing integrity and result in loss of therapy or inappropriate therapy, such as a short within the header.
- **Handling the terminal while tunneling.** Do not contact any other portion of the DF4–LLHH or DF4–LLHO lead terminal, other than the terminal pin, even when the lead cap is in place.

Programming and Device Operations

- **Atrial tracking modes.** Do not use atrial tracking modes in patients with chronic refractory atrial tachyarrhythmias. Tracking of atrial arrhythmias could result in ventricular tachyarrhythmias.

Post-Implant

- **Protected environments.** Advise patients to seek medical guidance before entering environments that could adversely affect the operation of the active implantable medical device, including areas protected by a warning notice that prevents entry by patients who have a pulse generator.

- **Magnetic Resonance Imaging (MRI) exposure.** Do not expose a patient to MRI scanning. Strong magnetic fields may damage the pulse generator and/or lead system, possibly resulting in injury to or death of the patient.
- **Diathermy.** Do not subject a patient with an implanted pulse generator and/or lead to diathermy since diathermy may cause fibrillation, burning of the myocardium, and irreversible damage to the pulse generator because of induced currents.
- **Ensure PTM is enabled.** If desired, ensure that Patient Triggered Monitor is enabled prior to sending the patient home by confirming the Magnet Response is programmed to Store EGM. If the feature is inadvertently left in the Inhibit Therapy setting, the patient could potentially disable tachyarrhythmia detection and therapy.
- **Magnet Response set to Inhibit Therapy.** Once the Patient Triggered Monitor feature has been triggered by the magnet and an EGM has been stored, or after 60 days have elapsed from the day that Store EGM was enabled, the Magnet Response programming automatically will be set to Inhibit Therapy. When this happens, the patient should not apply the magnet because tachyarrhythmia therapy could be inhibited.

PRECAUTIONS

Clinical Considerations

- **Pacemaker-mediated tachycardia (PMT).** Programming minimum PVARP less than retrograde V–A conduction may increase the likelihood of a PMT.

Sterilization and Storage

- **If package is damaged.** The blister trays and contents are sterilized with ethylene oxide gas before final packaging. When the pulse generator and/or lead is received, it is sterile provided the container is intact. If the packaging is wet, punctured, opened, or otherwise damaged, return the pulse generator and/or lead to Boston Scientific.

- **If device is dropped.** Do not implant a device which has been dropped while outside of its intact shelf package. Do not implant a device which has been dropped from a height of more than 24 inches (61 cm) while within its intact shelf package. Sterility, integrity, and/or function cannot be guaranteed under these conditions, and the device should be returned to Boston Scientific for inspection.
- **Storage temperature and equilibration.** Recommended storage temperatures are 0°C–50°C (32°F–122°F). Allow the device to reach a proper temperature before using telemetry communication capabilities, programming, or implanting the device because temperature extremes may affect initial device function.
- **Device storage.** Store the pulse generator in a clean area away from magnets, kits containing magnets, and sources of EMI to avoid device damage.
- **Use by date.** Implant the pulse generator and/or lead before or on the USE BY date on the package label because this date reflects a validated shelf life. For example, if the date is January 1, do not implant on or after January 2.

Implantation

- **Expected benefits.** Determine whether the expected device benefits provided by programmable options outweigh the possibility of more rapid battery depletion.
- **Evaluate patient for surgery.** There may be additional factors regarding the patient's overall health and medical condition that, while not related to device function or purpose, could render the patient a poor candidate for implantation of this system. Cardiac health advocacy groups may have published guidelines that may be helpful in conducting this evaluation.
- **Lead compatibility.** Prior to implantation, confirm the lead-to-pulse generator compatibility. Using incompatible leads and pulse generators can damage the connector and/or result in potential adverse consequences, such as undersensing of cardiac activity or failure to deliver necessary therapy.
- **Telemetry wand.** Make sure a sterile telemetry wand is available should loss of ZIP telemetry occur. Verify that the wand can easily be connected to the programmer and is within reach of the pulse generator.

- **Line-powered equipment.** Exercise extreme caution if testing leads using line-powered equipment because leakage current exceeding 10 μA can induce ventricular fibrillation. Ensure that any line-powered equipment is within specifications.
- **Replacement device.** Implanting a replacement device in a subcutaneous pocket that previously housed a larger device may result in pocket air entrapment, migration, erosion, or insufficient grounding between the device and tissue. Irrigating the pocket with sterile saline solution decreases the possibility of pocket air entrapment and insufficient grounding. Suturing the device in place reduces the possibility of migration and erosion.
- **Do not bend the lead near the lead-header interface.** Insert the lead terminal straight into the lead port. Do not bend the lead near the lead-header interface. Improper insertion can cause insulation or connector damage.
- **Absence of a lead.** The absence of a lead or plug in a lead port may affect device performance. If a lead is not used, be sure to properly insert a plug in the unused port, and then tighten the setscrew onto the plug.
- **Electrode connections.** Do not insert a lead into the pulse generator connector without taking the following precautions to ensure proper lead insertion:
 - Insert the torque wrench into the preslit depression of the seal plug before inserting the lead into the port, to release any trapped fluid or air.
 - Visually verify that the setscrew is sufficiently retracted to allow insertion. Use the torque wrench to loosen the setscrew if necessary.
 - Fully insert each lead into its lead port and then tighten the setscrew onto the terminal pin.
- **Defibrillation lead impedance.** If total shocking lead impedance during implant is less than 20 Ω , verify the proximal coil is not in contact with the pulse generator surface. A measurement of less than 20 Ω is an indication of a short somewhere in the system. If repeated measurements show the total shocking lead impedance is less than 20 Ω , the lead and/or pulse generator may need to be replaced.

- **Shunting energy.** Do not allow any object that is electrically conductive to come into contact with the lead or device during induction because it may shunt energy, resulting in less energy getting to the patient, and may damage the implanted system.
- **Do not suture directly over lead.** Do not suture directly over the lead body, as this may cause structural damage. Use the suture sleeve to secure the lead proximal to the venous entry site to prevent lead movement.

Device Programming

- **Device communication.** Use only the designated programmer and software application to communicate with this pulse generator.
- **STAT PACE settings.** When a pulse generator is programmed to STAT PACE settings, it will continue to pace at the high-energy STAT PACE values if it is not reprogrammed. The use of STAT PACE parameters will likely decrease device longevity.
- **Pacing and sensing margins.** Consider lead maturation in your choice of Pacing Amplitude, pacing Pulse Width, and Sensitivity settings.
 - An acute Pacing Threshold greater than 1.5 V or a chronic Pacing Threshold greater than 3 V can result in loss of capture because thresholds may increase over time.
 - An R-Wave Amplitude less than 5 mV or a P-Wave Amplitude less than 2 mV can result in undersensing because the sensed amplitude may decrease after implantation.
 - Pacing Lead Impedance should be greater than the programmed Low Impedance Limit and less than the programmed High Impedance Limit.
- **Proper programming of the shock vector.** If the Shock Vector is programmed to RVcoil>>RAcoil and the lead does not have an RA coil, shocking will not occur.

- **Programming for supraventricular tachyarrhythmias (SVTs).** Determine if the device and programmable options are appropriate for patients with SVTs because SVTs can initiate unwanted device therapy.
- **Adaptive-rate pacing.** Rate Adaptive Pacing should be used with care in patients who are unable to tolerate increased pacing rates.
- **Ventricular refractory periods (VRPs) in adaptive-rate pacing.** Adaptive-rate pacing is not limited by refractory periods. A long refractory period programmed in combination with a high MSR can result in asynchronous pacing during refractory periods since the combination can cause a very small sensing window or none at all. Use Dynamic AV Delay or Dynamic PVARP to optimize sensing windows. If you are programming a fixed AV Delay, consider the sensing outcomes.
- **Shock waveform polarity.** For IS-1/DF-1 leads, never change the shock waveform polarity by physically switching the lead anodes and cathodes in the pulse generator header—use the programmable Polarity feature. Device damage or nonconversion of the arrhythmia post-operatively may result if the polarity is switched physically.
- **Tachy Mode to Off.** To prevent inappropriate shocks, ensure that the pulse generator's Tachy Mode is programmed to Off when not in use and before handling the device. For tachyarrhythmia detection and therapy, verify that the Tachy Mode is programmed to Monitor + Therapy.
- **Atrial oversensing.** Take care to ensure that artifacts from the ventricles are not present on the atrial channel, or atrial oversensing may result. If ventricular artifacts are present in the atrial channel, the atrial lead may need to be repositioned to minimize its interaction.
- **ATR entry count.** Exercise care when programming the Entry Count to low values in conjunction with a short ATR Duration. This combination allows mode switching with very few fast atrial beats. For example, if the Entry Count was programmed to 2 and the ATR Duration to 0, ATR mode switching could occur on 2 fast atrial intervals. In these instances, a short series of premature atrial events could cause the device to mode switch.

- **ATR exit count.** Exercise care when programming the Exit Count to low values. For example, if the Exit Count was programmed to 2, a few cycles of atrial undersensing could cause termination of mode switching.
- **Proper programming without an atrial lead.** If an atrial lead is not implanted (port is plugged instead), or an atrial lead is abandoned but remains connected to the header, device programming should be consistent with the number and type of leads actually in use.
- **Atrial sensing programmed to Off.** When atrial sensing is programmed to Off in a DDI(R) or DDD(R) mode, any atrial pacing that occurs will be asynchronous. Additionally, features that require atrial sensing may not function as expected.
- **Cross-chamber artifacts.** Sensitivity adjustments associated with Smart Blanking may not be sufficient to inhibit detection of cross-chamber artifacts if the cross-chamber artifacts are too large. Consider other factors that impact the size/amplitude of cross-chamber artifacts including lead-placement, pacing output, programmed Sensitivity settings, shock output, and time since last delivered shock.
- **Sensor signal artifacts.** If Respiratory Sensor signal artifacts are observed on EGMs, and the leads are otherwise shown to be performing appropriately, consider programming the sensor to Off to prevent oversensing.
- **Sensing adjustment.** Following any sensing range adjustment or any modification of the sensing lead, always verify appropriate sensing. Programming Sensitivity to the highest value (lowest sensitivity) may result in delayed detection or undersensing of cardiac activity. Likewise, programming to the lowest value (highest sensitivity) may result in oversensing of non-cardiac signals.
- **Programming Respiratory Sensor when Tachy Mode is Off.** For INCEPTA, ENERGEN, and TELIGEN devices, the Respiratory Sensor will not be suspended due to 3 fast intervals if the Tachy Mode is set to Off. Consider turning the Respiratory Sensor Off when Tachy Mode is Off to prevent potential oversensing and pauses in pacing.

- **Patients hear tones coming from their device.** Patients should be advised to contact their physician immediately if they hear tones coming from their device.
- **Use of Patient Triggered Monitor.** Use care when using Patient Triggered Monitor, because the following conditions will exist while it is enabled:
 - All other magnet features, including inhibiting therapy, are disabled. The Magnet/Beeper feature will not indicate magnet position.
 - Device longevity is impacted. To help reduce the longevity impact, PTM only allows storage of one episode, and PTM is automatically disabled after 60 days if data storage was never triggered.
 - Once the EGM is stored (or 60 days elapses), PTM is disabled and the device Magnet Response automatically will be set to Inhibit Therapy. However, the pulse generator will not inhibit therapy until the magnet is removed for 3 seconds and placed on the device again.

Environmental and Medical Therapy Hazards

- **Avoid electromagnetic interference (EMI).** Advise patients to avoid sources of EMI because EMI may cause the pulse generator to deliver inappropriate therapy or inhibit appropriate therapy.

Moving away from the source of the EMI or turning off the source usually allows the pulse generator to return to normal operation.

Examples of potential EMI sources are:

- Electrical power sources, arc welding or resistance welding equipment, and robotic jacks
- High voltage power distribution lines
- Electrical smelting furnaces
- Large RF transmitters such as radar
- Radio transmitters, including those used to control toys

- Electronic surveillance (antitheft) devices
- An alternator on a car that is running
- Medical treatments and diagnostic tests in which an electrical current is passed through the body, such as TENS, electrocautery, electrolysis/thermolysis, electrodiagnostic testing, electromyography, or nerve conduction studies
- Any externally applied device that uses an automatic lead detection alarm system (e.g., an EKG machine)
- **Wireless ECG.** Wireless ECG is susceptible to RF interference, and may have an intermittent or lost signal. If interference is present, especially during diagnostic testing, consider using a surface ECG instead.

Hospital and Medical Environments

- **Mechanical ventilators.** During mechanical ventilation, respiration-based trending may be misleading; therefore, the Respiratory Sensor should be programmed to Off.
- **Conducted electrical current.** Any medical equipment, treatment, therapy, or diagnostic test that introduces electrical current into the patient has the potential to interfere with pulse generator function.
 - External patient monitors (e.g., respiratory monitors, surface ECG monitors, hemodynamic monitors) may interfere with the pulse generator's impedance-based diagnostics (e.g., shock lead impedance measurements, Respiratory Rate trend). To resolve suspected interactions with Respiratory Sensor-based diagnostics, deactivate the pulse generator's Respiratory Sensor by programming it to Off.
 - Medical therapies, treatments, and diagnostic tests that use conducted electrical current (e.g., TENS, electrocautery, electrolysis/thermolysis, electrodiagnostic testing, electromyography, or nerve conduction studies) may interfere with or damage the pulse generator. Program the device to Electrocautery Protection Mode prior to the treatment, and monitor device performance during the

treatment. After the treatment, verify pulse generator function ("Post-Therapy Pulse Generator Follow Up" on page 19).

- **Internal defibrillation.** Do not use internal defibrillation paddles or catheters unless the pulse generator is disconnected from the leads because the leads may shunt energy. This could result in injury to the patient and damage to the implanted system.
- **External defibrillation.** It can take up to 15 seconds for sensing to recover after an external shock is delivered. In non-emergency situations, for pacemaker dependent patients, consider programming the pulse generator to an asynchronous pacing mode and programming the Respiratory Sensor to Off prior to performing external cardioversion or defibrillation.

Avoid placing a pad (or paddle) directly over any subcutaneous leads.

External defibrillation or cardioversion can damage the pulse generator. To help prevent damage to the pulse generator, consider the following:

- Avoid placing a pad (or paddle) directly over the pulse generator. Position the pads (or paddles) as far from the pulse generator as possible.
- Position the pads (or paddles) in a posterior-anterior orientation when the device is implanted in the right pectoral region or an anterior-apex orientation when the device is implanted in the left pectoral region.
- Set energy output of external defibrillation equipment as low as clinically acceptable.

Following external cardioversion or defibrillation, verify pulse generator function ("Post-Therapy Pulse Generator Follow Up" on page 19).

- **Lithotripsy.** Extracorporeal shock wave lithotripsy (ESWL) may cause electromagnetic interference with or damage to the pulse generator. If ESWL is medically necessary, consider the following to minimize the potential for encountering interaction:
 - Focus the ESWL beam at least 15 cm (6 in) away from the pulse generator.

- Depending on the pacing needs of the patient, program the Brady Mode to Off or a non-rate-responsive VVI mode.
- Program the Tachy Mode to Off to prevent inappropriate shocks.
- **Ultrasound energy.** Therapeutic ultrasound (e.g., lithotripsy) energy may damage the pulse generator. If therapeutic ultrasound energy must be used, avoid focusing near the pulse generator site. Diagnostic ultrasound (e.g., echocardiography) is not known to be harmful to the pulse generator.
- **Electrical interference.** Electrical interference or “noise” from devices such as electrocautery and monitoring equipment may interfere with establishing or maintaining telemetry for interrogating or programming the device. In the presence of such interference, move the programmer away from electrical devices, and ensure that the wand cord and cables are not crossing one another. If telemetry is cancelled as a result of interference, the device should be re-interrogated prior to evaluating information from pulse generator memory.
- **Radio frequency (RF) interference.** RF signals from devices that operate at frequencies near that of the pulse generator may interrupt ZIP telemetry while interrogating or programming the pulse generator. This RF interference can be reduced by increasing the distance between the interfering device and the PRM and pulse generator. Examples of devices that may cause interference in the 916.5 MHz frequency band include:
 - Cordless phone handsets or base stations
 - Certain patient monitoring systems
- **Central line guidewire insertion.** Use caution when inserting guidewires for placement of other types of central venous catheter systems such as PIC lines or Hickman catheters in locations where pulse generator leads may be encountered. Insertion of such guidewires into veins containing leads could result in the leads being damaged or dislodged.

Home and Occupational Environments

- **Home appliances.** Home appliances that are in good working order and properly grounded do not usually produce enough EMI to interfere with pulse generator operation. There have been reports of pulse generator disturbances caused by electric hand tools or electric razors used directly over the pulse generator implant site.
- **Magnetic fields.** Advise patients that extended exposure to strong (greater than 10 gauss or 1 mTesla) magnetic fields may trigger the magnet feature. Examples of magnetic sources include:
 - Industrial transformers and motors
 - MRI scanners
 - Large stereo speakers
 - Telephone receivers if held within 1.27 cm (0.5 inches) of the pulse generator
 - Magnetic wands such as those used for airport security and in the Bingo game
- **Electronic Article Surveillance (EAS) and security systems.** Advise patients to avoid lingering near or leaning against anti-theft and security gates or tag readers that include radio frequency identification (RFID) equipment. These systems may be found at the entrances and exits of stores, in public libraries, and in point-of-entry access control systems. These systems are unlikely to affect cardiac device function when patients walk through them at a normal pace. If the patient is near an electronic anti-theft, security, or entry control system and experiences symptoms, they should promptly move away from nearby equipment and inform their doctor.
- **Cellular phones.** Advise patients to hold cellular phones to the ear opposite the side of the implanted device. Patients should not carry a cellular phone that is turned on in a breast pocket or on a belt within 15 cm (6 inches) of the implanted device since some cellular phones may cause the pulse generator to deliver inappropriate therapy or inhibit appropriate therapy.

Follow-up Testing

- **Conversion testing.** Successful VF or VT conversion during arrhythmia conversion testing is no assurance that conversion will occur post-operatively. Be aware that changes in the patient's condition, drug regimen, and other factors may change the DFT, which may result in nonconversion of the arrhythmia post-operatively.
- **Pacing threshold testing.** If the patient's condition or drug regimen has changed or device parameters have been reprogrammed, consider performing a pacing threshold test to confirm adequate margins for pace capture.
- **Follow-up considerations for patients leaving the country.** Pulse generator follow-up considerations should be made in advance for patients who plan to travel or relocate post-implant to a country other than the country in which their device was implanted. Regulatory approval status for devices and associated programmer software configurations varies by country; certain countries may not have approval or capability to follow specific products.

Contact Boston Scientific, using the information on the back cover, for help in determining feasibility of device follow-up in the patient's destination country.

Explant and Disposal

- **Incineration.** Be sure that the pulse generator is removed before cremation. Cremation and incineration temperatures might cause the pulse generator to explode.
- **Device handling.** Before explanting, cleaning, or shipping the device, complete the following actions to prevent unwanted shocks, overwriting of important therapy history data, and audible tones:
 - Program the pulse generator Tachy and Brady Modes to Off.
 - Program the Magnet Response feature to Off.
 - Program the Beep when Explant is Indicated feature to Off.
 - Program the Beep When Out-of-Range feature to Off

Clean and disinfect the device using standard biohazard handling techniques.

SUPPLEMENTAL PRECAUTIONARY INFORMATION

Post-Therapy Pulse Generator Follow Up

Following any surgery or medical procedure with the potential to affect pulse generator function, you should perform a thorough follow-up, which may include the following:

- Interrogating the pulse generator with a programmer
- Reviewing clinical events and fault codes
- Reviewing the Arrhythmia Logbook, including stored electrograms (EGMs)
- Reviewing real-time EGMs
- Testing the leads (threshold, amplitude, and impedance)
- Performing a manual capacitor re-formation
- Reviewing respiratory sensor-based diagnostics
- Verifying battery status
- Programming any permanent brady parameter to a new value and then reprogramming it back to the desired value
- Programming the Tachy Mode to a new value and then reprogramming it back to the desired value
- Saving all patient data
- Verifying the appropriate final programming prior to allowing the patient to leave the clinic

Transcutaneous Electrical Nerve Stimulation (TENS)

CAUTION: TENS involves passing electrical current through the body, and may interfere with pulse generator function. If TENS is medically necessary, evaluate the TENS therapy settings for compatibility with the pulse generator. The following guidelines may reduce the likelihood of interaction:

- Place the TENS electrodes as close together and as far away from the pulse generator and leads as possible.
- Use the lowest clinically-appropriate TENS energy output.
- Consider cardiac monitoring during TENS use, especially for pacemaker-dependent patients.

Additional steps can be taken to help reduce interference during in-clinic use of TENS:

- If interference is suspected during in-clinic use, turn off the TENS unit.
- Do not change TENS settings until you have verified that the new settings do not interfere with pulse generator function.

If TENS is medically necessary outside the clinical setting (at-home use), provide patients with the following instructions:

- Do not change the TENS settings or electrode positions unless instructed to do so.
- End each TENS session by turning off the unit before removing the electrodes.
- If the patient receives a shock during TENS use, or if they experience symptoms of lightheadedness, dizziness, or loss of consciousness, they should turn off the TENS unit and contact their physician.

Follow these steps to use the PRM to evaluate pulse generator function during TENS use:

1. Program the pulse generator Tachy Mode to Monitor Only.
2. Observe real-time EGMs at prescribed TENS output settings, noting when appropriate sensing or interference occurs.

NOTE: Patient triggered monitoring may be used as an additional method to confirm device function during TENS use.

3. When finished, turn off the TENS unit and reprogram the Tachy Mode to Monitor + Therapy.

You should also perform a thorough follow-up evaluation of the pulse generator following TENS, to ensure that device function has not been compromised ("Post-Therapy Pulse Generator Follow Up" on page 19).

For additional information, contact Boston Scientific using the information on the back cover.

Electrocautery and Radio Frequency (RF) Ablation

CAUTION: Electrocautery and RF ablation may induce ventricular arrhythmias and/or fibrillation, and may cause asynchronous pacing, inhibition of pacing, inappropriate shocks, and/or a reduction in pulse generator pacing output possibly leading to loss of capture. RF ablation may also cause ventricular pacing up to the MTR and/or changes in pacing thresholds. Additionally, exercise caution when performing any other type of cardiac ablation procedure in patients with implanted devices.

If electrocautery or RF ablation is medically necessary, observe the following to minimize risk to the patient and device:

- Depending on the pacing needs of the patient, program the Tachy Mode to Electrocautery Protection Mode or Off.
- Have temporary pacing and external defibrillation equipment available.
- Avoid direct contact between the electrocautery equipment or ablation catheters and the pulse generator and leads. RF ablation close to the lead electrode may damage the lead-tissue interface.
- Keep the path of the electrical current as far away as possible from the pulse generator and leads.
- If RF ablation and/or electrocautery is performed on tissue near the device or leads, monitor pre- and post-measurements for sensing and pacing thresholds and impedances to determine the integrity and stability of the system.

- For electrocautery, use a bipolar electrocautery system where possible and use short, intermittent, and irregular bursts at the lowest feasible energy levels.
- RF ablation equipment may cause telemetry interference between the pulse generator and PRM. If device programming changes are necessary during an RF ablation procedure, turn off the RF ablation equipment before interrogation.

When the procedure is finished, cancel the Electrocautery Protection Mode or program Tachy Mode to Monitor + Therapy in order to reactivate the previously programmed therapy modes.

Ionizing Radiation

CAUTION: It is not possible to specify a safe radiation dosage or guarantee proper pulse generator function following exposure to ionizing radiation. Multiple factors collectively determine the impact of radiation therapy on an implanted pulse generator, including proximity of the pulse generator to the radiation beam, type and energy level of the radiation beam, dose rate, total dose delivered over the life of the pulse generator, and shielding of the pulse generator. The impact of ionizing radiation will also vary from one pulse generator to another and may range from no changes in function to a loss of pacing and defibrillation therapy.

Sources of ionizing radiation vary significantly in their potential impact on an implanted pulse generator. Several therapeutic radiation sources are capable of interfering with or damaging an implanted pulse generator, including those used for the treatment of cancer, such as radioactive cobalt, linear accelerators, radioactive seeds, and betatrons.

Prior to a course of therapeutic radiation treatment, the patient's radiation oncologist and cardiologist or electrophysiologist should consider all patient management options, including increased follow-up and device replacement. Other considerations include:

- Maximizing shielding of the pulse generator within the treatment field
- Determining the appropriate level of patient monitoring during treatment

Evaluate pulse generator operation during and following the course of radiation treatment to exercise as much device functionality as possible ("Post-Therapy Pulse Generator Follow Up" on page 19). The extent, timing, and frequency of this evaluation relative to the radiation therapy regimen are dependent upon current patient health, and therefore should be determined by the attending cardiologist or electrophysiologist.

Many pulse generator diagnostics are performed automatically once per hour, so pulse generator evaluation should not be concluded until pulse generator diagnostics have been updated and reviewed (at least one hour after radiation exposure). The effects of radiation exposure on the implanted pulse generator may remain undetected until some time following exposure. For this reason, continue to monitor pulse generator function closely and use caution when programming a feature in the weeks or months following radiation therapy.

Elevated Pressures

The International Standards Organization (ISO) has not approved a standardized pressure test for implantable pulse generators that experience hyperbaric oxygen therapy (HBOT) or SCUBA diving. However, Boston Scientific developed a test protocol to evaluate device performance upon exposure to elevated atmospheric pressures. The following summary of pressure testing should not be viewed as and is not an endorsement of HBOT or SCUBA diving.

CAUTION: Elevated pressures due to HBOT or SCUBA diving may damage the pulse generator. During laboratory testing, all pulse generators in the test sample functioned as designed when exposed to more than 1000 cycles at a pressure up to 5.0 ATA. Laboratory testing did not characterize the impact of elevated pressure on pulse generator performance or physiological response while implanted in a human body.

Pressure for each test cycle began at ambient/room pressure, increased to a high pressure level, and then returned to ambient pressure. Although dwell time (the amount of time under elevated pressure) may have an impact on human physiology, testing indicated it did not impact pulse generator performance. Pressure value equivalencies are provided below (Table 1 Pressure Value Equivalencies on page 24).

Table 1. Pressure Value Equivalencies

Pressure value equivalencies	
Atmospheres Absolute	5.0 ATA
Sea water depth ^a	40 m (130 ft)
Pressure, absolute	72.8 psia
Pressure, gauge ^b	58.1 psig
Bar	5.0
kPa Absolute	500

a. All pressures were derived assuming sea water density of 1030 kg/m³.

b. Pressure as read on a gauge or dial (psia = psig + 14.7 psi).

Prior to SCUBA diving or starting an HBOT program, the patient's attending cardiologist or electrophysiologist should be consulted to fully understand the potential consequences relative to the patient's specific health condition. A Dive Medicine Specialist may also be consulted prior to SCUBA diving.

More frequent device follow-up may be warranted in conjunction with HBOT or SCUBA diving. Evaluate pulse generator operation following high pressure exposure ("Post-Therapy Pulse Generator Follow Up" on page 19). The extent, timing, and frequency of this evaluation relative to the high pressure exposure are dependent upon current patient health, and should be determined by the attending cardiologist or electrophysiologist.

If you have additional questions, or would like more detail regarding the test protocol or test results specific to HBOT or SCUBA diving, contact Boston Scientific using the information on the back cover.

POTENTIAL ADVERSE EVENTS

Based on the literature and on pulse generator and/or lead implant experience, the following alphabetical list includes the possible adverse events associated with implantation of products described in this literature:

- Air embolism
- Allergic reaction
- Bleeding
- Bradycardia
- Cardiac tamponade
- Chronic nerve damage
- Component failure
- Conductor coil fracture
- Death
- Elevated thresholds
- Erosion
- Excessive fibrotic tissue growth
- Extracardiac stimulation (muscle/nerve stimulation)
- Failure to convert an induced arrhythmia
- Fluid accumulation
- Foreign body rejection phenomena
- Formation of hematomas or seromas
- Heart block
- Heart failure following chronic RV apical pacing
- Inability to defibrillate or pace

- Inappropriate therapy (e.g., shocks and antitachycardia pacing [ATP] where applicable, pacing)
- Incisional pain
- Incomplete lead connection with pulse generator
- Infection including endocarditis
- Insulating myocardium during defibrillation with internal or external paddles
- Lead dislodgment
- Lead fracture
- Lead insulation breakage or abrasion
- Lead perforation
- Lead tip deformation and/or breakage
- Local tissue reaction
- Loss of capture
- Myocardial infarction (MI)
- Myocardial necrosis
- Myocardial trauma (e.g., tissue damage, valve damage)
- Myopotential sensing
- Oversensing/undersensing
- Pacemaker-mediated tachycardia (PMT) (Applies to dual-chamber devices only.)
- Pericardial rub, effusion
- Pneumothorax
- Pulse generator migration
- Shunting current during defibrillation with internal or external paddles
- Syncope

- Tachyarrhythmias, which include acceleration of arrhythmias and early, recurrent atrial fibrillation
- Thrombosis/thromboemboli
- Valve damage
- Vasovagal response
- Venous occlusion
- Venous trauma (e.g., perforation, dissection, erosion)
- Worsening heart failure

Patients may develop psychological intolerance to a pulse generator system and may experience the following:

- Dependency
- Depression
- Fear of premature battery depletion
- Fear of shocking while conscious
- Fear that shocking capability may be lost
- Imagined shocking
- Fear of device malfunction

MECHANICAL SPECIFICATIONS

The following mechanical specifications and material specifications apply to AUTOGEN, DYNAGEN, INOGEN, and ORIGEN devices.

All Extended Longevity (EL) ICD models have a case electrode surface area of 6192 mm². Usable battery capacity is 1.9 Ah and residual usable battery capacity at Explant is 0.12 Ah for single chamber devices and 0.12 Ah for dual chamber devices. Mechanical specifications specific to each model are listed below.

All MINI ICD models have a case electrode surface area of 5487 mm². Usable battery capacity is 1.0 Ah and residual usable battery capacity at Explant is 0.12 Ah for single chamber devices and 0.12 Ah for dual chamber devices. Mechanical specifications specific to each model are listed below.

Table 2. Mechanical Specifications - AUTOGEN Extended Longevity (EL) ICDs

Model	Dimensions W x H x D (cm)	Mass (g)	Volume (cm³)	Connector Type
D160 (VR)	5.37 x 7.36 x 0.99	68.9	29.5	RV: DF4
D161 (VR)	5.37 x 7.79 x 0.99	70.7	31.5	RV: IS-1/DF-1
D162 (DR)	5.37 x 7.68 x 0.99	71.4	31.0	RA: IS-1; RV: DF4
D163 (DR)	5.37 x 7.79 x 0.99	71.0	31.5	RA: IS-1; RV: IS-1/DF-1

Table 3. Mechanical Specifications - DYNAGEN Extended Longevity (EL) ICDs

Model	Dimensions W x H x D (cm)	Mass (g)	Volume (cm³)	Connector Type
D150 (VR)	5.37 x 7.36 x 0.99	68.9	29.5	RV: DF4
D151 (VR)	5.37 x 7.79 x 0.99	70.7	31.5	RV: IS-1/DF-1

Table 3. Mechanical Specifications - DYNAGEN Extended Longevity (EL) ICDs (continued)

Model	Dimensions W x H x D (cm)	Mass (g)	Volume (cm³)	Connector Type
D152 (DR)	5.37 x 7.68 x 0.99	71.4	31.0	RA: IS-1; RV: DF4
D153 (DR)	5.37 x 7.79 x 0.99	71.0	31.5	RA: IS-1; RV: IS-1/DF-1

Table 4. Mechanical Specifications - DYNAGEN MINI ICDs

Model	Dimensions W x H x D (cm)	Mass (g)	Volume (cm³)	Connector Type
D020 (VR)	5.23 x 6.71 x 0.99	60.0	26.5	RV: DF4
D021 (VR)	5.23 x 7.14 x 0.99	61.9	28.5	RV: IS-1/DF-1
D022 (DR)	5.23 x 7.03 x 0.99	62.5	28.0	RA: IS-1; RV: DF4
D023 (DR)	5.23 x 7.14 x 0.99	62.3	28.5	RA: IS-1; RV: IS-1/DF-1

Table 5. Mechanical Specifications - INOGEN Extended Longevity (EL) ICDs

Model	Dimensions W x H x D (cm)	Mass (g)	Volume (cm³)	Connector Type
D140 (VR)	5.37 x 7.36 x 0.99	68.9	29.5	RV: DF4
D141 (VR)	5.37 x 7.79 x 0.99	70.7	31.5	RV: IS-1/DF-1
D142 (DR)	5.37 x 7.68 x 0.99	71.4	31.0	RA: IS-1; RV: DF4
D143 (DR)	5.37 x 7.79 x 0.99	71.0	31.5	RA: IS-1; RV: IS-1/DF-1

Table 6. Mechanical Specifications - INOGEN MINI ICDs

Model	Dimensions W x H x D (cm)	Mass (g)	Volume (cm³)	Connector Type
D010 (VR)	5.23 x 6.71 x 0.99	60.0	26.5	RV: DF4
D011 (VR)	5.23 x 7.14 x 0.99	61.9	28.5	RV: IS-1/DF-1
D012 (DR)	5.23 x 7.03 x 0.99	62.5	28.0	RA: IS-1; RV: DF4
D013 (DR)	5.23 x 7.14 x 0.99	62.3	28.5	RA: IS-1; RV: IS-1/DF-1

Table 7. Mechanical Specifications - ORIGEN Extended Longevity (EL) ICDs

Model	Dimensions W x H x D (cm)	Mass (g)	Volume (cm³)	Connector Type
D050 (VR)	5.37 x 7.36 x 0.99	68.9	29.5	RV: DF4
D051 (VR)	5.37 x 7.79 x 0.99	70.7	31.5	RV: IS-1/DF-1
D052 (DR)	5.37 x 7.68 x 0.99	71.4	31.0	RA: IS-1; RV: DF4
D053 (DR)	5.37 x 7.79 x 0.99	71.0	31.5	RA: IS-1; RV: IS-1/DF-1

Table 8. Mechanical Specifications - ORIGEN MINI ICDs

Model	Dimensions W x H x D (cm)	Mass (g)	Volume (cm³)	Connector Type
D000 (VR)	5.23 x 6.71 x 0.99	60.0	26.5	RV: DF4
D001 (VR)	5.23 x 7.14 x 0.99	61.9	28.5	RV: IS-1/DF-1
D002 (DR)	5.23 x 7.03 x 0.99	62.5	28.0	RA: IS-1; RV: DF4
D003 (DR)	5.23 x 7.14 x 0.99	62.3	28.5	RA: IS-1; RV: IS-1/DF-1

Material specifications are shown below:

- **Case:** hermetically sealed titanium
- **Header:** implantation-grade polymer
- **Power Supply (EL):** lithium-manganese dioxide cell; Boston Scientific ENDURALIFE; 401988
- **Power Supply (MINI):** lithium-manganese dioxide cell; Boston Scientific; 400010

The following mechanical specifications and material specifications apply to INCEPTA, ENERGEN, and PUNCTUA devices.

All models have a mass of 72.0 g and a case electrode surface area of 6670 mm². Usable battery capacity is 1.8 Ah and residual usable battery capacity at Explant is 0.12 Ah for single chamber devices and 0.13 Ah for dual chamber devices. Mechanical specifications specific to each model are listed below.

Table 9. Mechanical Specifications - INCEPTA ICDs

Model	Dimensions W x H x D (cm)	Volume (cm³)	Connector Type
E160 (VR)	6.17 x 6.90 x 0.99	30.5	RV: DF4-LLHH
E161 (VR)	6.17 x 7.45 x 0.99	31.5	RV: IS-1/DF-1
E162 (DR)	6.17 x 7.40 x 0.99	31.5	RA: IS-1, RV: DF4-LLHH
E163 (DR)	6.17 x 7.45 x 0.99	31.5	RA: IS-1, RV: IS-1/DF-1

Table 10. Mechanical Specifications - ENERGEN ICDs

Model	Dimensions W x H x D (cm)	Volume (cm³)	Connector Type
E140 (VR)	6.17 x 6.90 x 0.99	30.5	RV: DF4-LLHH
E141 (VR)	6.17 x 7.45 x 0.99	31.5	RV: IS-1/DF-1
E142 (DR)	6.17 x 7.40 x 0.99	31.5	RA: IS-1, RV: DF4-LLHH
E143 (DR)	6.17 x 7.45 x 0.99	31.5	RA: IS-1, RV: IS-1/DF-1

Table 11. Mechanical Specifications - PUNCTUA ICDs

Model	Dimensions W x H x D (cm)	Volume (cm³)	Connector Type
E050 (VR)	6.17 x 6.90 x 0.99	30.5	RV: DF4-LLHH
E051 (VR)	6.17 x 7.45 x 0.99	31.5	RV: IS-1/DF-1
E052 (DR)	6.17 x 7.40 x 0.99	31.5	RA: IS-1, RV: DF4-LLHH
E053 (DR)	6.17 x 7.45 x 0.99	31.5	RA: IS-1, RV: IS-1/DF-1

Material specifications are shown below:

- **Case:** hermetically sealed titanium
- **Header:** implantation-grade polymer
- **Power Supply:** lithium-manganese dioxide cell; Boston Scientific ENDURALIFE; 401988

The following mechanical specifications and material specifications apply to TELIGEN devices.

All models have a mass of 72.0 g and a case electrode surface area of 6670 mm². Usable battery capacity is 1.7 Ah and residual usable battery capacity at Explant is 0.12 Ah for single chamber devices and 0.13 Ah for dual chamber devices. Mechanical specifications specific to each model are listed below.

Table 12. Mechanical Specifications - TELIGEN ICDs

Model	Dimensions W x H x D (cm)	Volume (cm³)	Connector Type
E102 (VR)	6.17 x 7.45 x 0.99	31.5	RV: IS-1/DF-1
E110 (DR)	6.17 x 7.45 x 0.99	31.5	RA: IS-1, RV: IS-1/DF-1

Material specifications are shown below:

- **Case:** hermetically sealed titanium
- **Header:** implantation-grade polymer
- **Power Supply:** lithium-manganese dioxide cell; Boston Scientific ENDURALIFE; 401988

ITEMS INCLUDED IN PACKAGE

The following items are included with the pulse generator:

- One torque wrench
- Product literature

NOTE: Accessories (e.g., wrenches) are intended for one-time use only. They should not be resterilized or reused.

SYMBOLS ON PACKAGING

The following symbols may be used on packaging and labeling (Table 13 Symbols on packaging on page 35):

Table 13. Symbols on packaging





Symbol	Description
	Reference number
	Package contents
	Pulse generator
	Torque wrench

Table 13. Symbols on packaging (continued)







Symbol	Description
	Literature enclosed
	Serial number
	Use by
	Lot number
	Date of manufacture
	Non-ionizing electromagnetic radiation
	Sterilized using ethylene oxide

Table 13. Symbols on packaging (continued)





Symbol	Description
	Do not re-sterilize
	Do not reuse
	Do not use if package is damaged
	Dangerous voltage
	Consult instructions for use on this website: www.boston-scientific-elabeling.com

Table 13. Symbols on packaging (continued)











Symbol	Description
	Temperature limitation
	Place telemetry wand here
	Open here
	Authorized Representative in the European Community
	Manufacturer
	CRT-D RA, RV, LV

Table 13. Symbols on packaging (continued)

Symbol	Description
	ICD RA, RV
	ICD RV
	Uncoated device
	RF Telemetry

CHARACTERISTICS AS SHIPPED

Refer to the table for pulse generator settings at shipment (Table 14 Characteristics as shipped on page 40).

Table 14. Characteristics as shipped

Parameter	Setting
Tachy Mode	Storage
Tachy Therapy available	ATP, Shock
Pacing Mode	Storage
Pacing Therapy available	DDDR (DR models) VVIR (VR models)
Sensor	Accelerometer
Pace/Sense Configuration	RA: BI/BI (DR models)
Pace/Sense Configuration	RV: BI/BI

The pulse generator is shipped in a power-saving Storage mode to extend its shelf life. In Storage mode, all features are inactive except:

- Telemetry support, which allows interrogation and programming
- Real-time clock
- Commanded capacitor re-formation
- STAT SHOCK and STAT PACE commands

The device leaves Storage mode when one of the following actions occurs; however, programming other parameters will not affect the Storage mode:

- STAT SHOCK or STAT PACE is commanded
- Tachy Mode is programmed to:
 - Off
 - Monitor Only
 - Monitor + Therapy

Once you have programmed the pulse generator out of Storage mode, the device cannot be reprogrammed to that mode.

X-RAY IDENTIFIER

The pulse generator has an identifier that is visible on x-ray film or under fluoroscopy. This identifier provides noninvasive confirmation of the manufacturer and consists of the following:

- For AUTOGEN, DYNAGEN, INOGEN, and ORIGEN pulse generators, the letters BSC identify Boston Scientific as the manufacturer. The number 140 identifies the Model 2868 PRM software application needed to communicate with the pulse generator.
- For INCEPTA, ENERGEN and PUNCTUA pulse generators, the letters BSC identify Boston Scientific as the manufacturer. The number 120 identifies the Model 2868 PRM software application needed to communicate with the pulse generator.
- For TELIGEN pulse generators, the letters BOS identify Boston Scientific as the manufacturer. The number 112 identifies the Model 2868 PRM software application needed to communicate with the pulse generator.

The x-ray identifier is embedded in the header of the device. For a left side pectoral implant, the identifier will be visible by x-ray or fluorography at the approximate location shown (Figure 1 X-ray identifier on page 42).

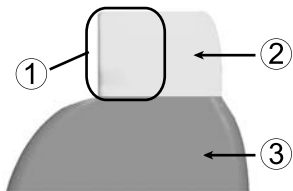

[1] X-Ray Identifier [2] Header [3] Pulse Generator Case

Figure 1. X-ray identifier

For information on identifying the device via the PRM, refer to the PRM Operator's Manual.

The pulse generator model number is stored in device memory and is shown on the PRM Summary screen once the pulse generator is interrogated.

FEDERAL COMMUNICATIONS COMMISSION (FCC)

This device complies with Title 47, Part 15 of the FCC rules. Operation is subject to the following two conditions:

- This device may not cause harmful interference, and
- This device must accept any interference received, including interference that may cause undesired operation.

For pulse generators operating with a transmit frequency of 402 to 405 MHz: this transmitter is authorized by rule under the Medical Device Radiocommunication Service (in part 95 of the FCC Rules) and must not cause harmful interference to stations operating in the 400.150–406.000 MHz band in the Meteorological Aids (i.e.,

transmitters and receivers used to communicate weather data), the Meteorological Satellite, or the Earth Exploration Satellite Services and must accept interference that may be caused by such stations, including interference that may cause undesired operation. This transmitter shall be used only in accordance with the FCC Rules governing the Medical Device Radiocommunication Service. Analog and digital voice communications are prohibited. Although this transmitter has been approved by the Federal Communications Commission, there is no guarantee that it will not receive interference or that any particular transmission from this transmitter will be free from interference.

CAUTION: Changes or modifications not expressly approved by Boston Scientific could void the user's authority to operate the equipment.

AUTOGEN, DYNAGEN, INOGEN, and ORIGEN devices operate in the 402–405 MHz band using FSK modulation with radiated power conforming to the applicable 25 μ W limit. The FCC ID is ESCCRMG17912. Wanded telemetry operates at 57 kHz and uses QPSK modulation.

INCEPTA, ENERGEN, and PUNCTUA devices operate with a transmit frequency of 916.5 MHz using ASK modulation with a maximum radiated output power of less than -1.25 dBm. The FCC ID is ESCCRMN11906. Wanded telemetry operates at 57 kHz and uses QPSK modulation.

TELIGEN devices operate with a transmit frequency of 916.5 MHz using ASK modulation with a maximum radiated output power of less than -1.25 dBm. The FCC ID is ESCCRMN11906. Wanded telemetry operates at 102.4 kHz and uses QPSK modulation.

PULSE GENERATOR LONGEVITY

Based on simulated studies, it is anticipated that these pulse generators have average longevity to explant as shown below.

Refer to the PRM Summary and Battery Detail Summary screens for an estimate of pulse generator longevity specific to the implanted device.

The longevity expectations, which account for the energy used during manufacture and storage, apply at the conditions shown in the tables along with the following:

- Assumes 60 ppm LRL, ventricular and atrial settings of 2.5 V pacing pulse Amplitude and 0.4 ms pacing pulse width; RA Impedance 500 Ω ; sensors On.

The following longevity tables and conditions of use apply to AUTOGEN, DYNAGEN, INOGEN, and ORIGEN devices.

Projected longevity is calculated assuming 3 maximum energy charging cycles per year, including automatic capacitor re-forms and therapeutic shocks. For the final year of device service, an additional 5 charging cycles are assumed to account for additional automatic capacitor re-forms as the device approaches the Explant indicator. These calculations also assume 3-channel EGM Onset is on and that the pulse generator spends 6 months in Storage mode during shipping and storage.

Table 15. Extended Longevity (EL) ICD pulse generator life expectancy estimation (implant to explant) with ENDURALIFE battery

All Models ^{a b}						
Pacing	Longevity (years) at 500 Ω , 700 Ω , and 900 Ω Pacing Impedance (RV)					
	500 Ω		700 Ω		900 Ω	
	VR	DR	VR	DR	VR	DR
0%	11.7	11.2	11.7	11.2	11.7	11.2
15%	11.5	10.8	11.5	10.9	11.6	10.9

Table 15. Extended Longevity (EL) ICD pulse generator life expectancy estimation (implant to explant) with ENDURALIFE battery (continued)

All Models ^{a b}						
Pacing	Longevity (years) at 500 Ω , 700 Ω , and 900 Ω Pacing Impedance (RV)					
	500 Ω		700 Ω		900 Ω	
	VR	DR	VR	DR	VR	DR
50%	11.0	10.0	11.1	10.1	11.2	10.2
100%	10.3	9.0	10.6	9.2	10.8	9.3

- a. Assumes ZIP telemetry use for 1 hour at implant and for 40 minutes annually for in-clinic follow-up checks.
 b. Assumes standard use of the LATITUDE Communicator as follows: Daily Device Check on, monthly Full Interrogations (scheduled remote follow ups, and quarterly patient-initiated interrogations).

Table 16. MINI ICD pulse generator life expectancy estimation (implant to explant)

All Models ^{a b}						
Pacing	Longevity (years) at 500 Ω , 700 Ω , and 900 Ω Pacing Impedance (RV)					
	500 Ω		700 Ω		900 Ω	
	VR	DR	VR	DR	VR	DR
0%	5.5	5.3	5.5	5.3	5.5	5.3
15%	5.4	5.1	5.4	5.1	5.5	5.1
50%	5.2	4.7	5.3	4.7	5.3	4.8
100%	4.9	4.2	5.0	4.3	5.1	4.4

- a. Assumes ZIP telemetry use for 1 hour at implant and for 40 minutes annually for in-clinic follow-up checks.
- b. Assumes standard use of the LATITUDE Communicator as follows: Daily Device Check on, monthly Full Interrogations (scheduled remote follow ups, and quarterly patient-initiated interrogations).

Table 17. AUTOGEN Extended Longevity (EL) ICD pulse generator life expectancy estimation (implant to explant) with ENDURALIFE battery and PaceSafe

All Models ^{a b}						
Pacing	Longevity (years) at 500 Ω, 700 Ω, and 900 Ω Pacing Impedance (RV)					
	500 Ω		700 Ω		900 Ω	
	VR	DR	VR	DR	VR	DR
PaceSafe On (RA=2.0 V, RV=2.0 V [assuming an RV threshold of < 1.0 and an RA threshold of < 1.0]). VR models estimated using RVAT only.						
15%	11.5	10.9	11.6	11.0	11.6	11.0
50%	11.2	10.4	11.3	10.5	11.4	10.5
100%	10.8	9.7	11.0	9.8	11.1	9.9

- a. Assumes ZIP telemetry use for 1 hour at implant and for 40 minutes annually for in-clinic follow-up checks.
 b. Assumes standard use of the LATITUDE Communicator as follows: Daily Device Check on, monthly Full Interrogations (scheduled remote follow ups, and quarterly patient-initiated interrogations).

NOTE: *The energy consumption in the longevity table is based upon theoretical electrical principles and verified via bench testing only.*

The pulse generator longevity may increase with a decrease in any of the following:

- Pacing rate

- Pacing pulse amplitude(s)
- Pacing pulse width(s)
- Percentage of paced to sensed events
- Charging frequency

Longevity is also affected in the following circumstances:

- A decrease in pacing impedance may reduce longevity.
- For Extended Longevity (EL) devices, when the Respiratory Sensor is programmed Off for the life of the device, longevity is increased by approximately 4.5 months.
- For MINI devices, when the Respiratory Sensor is programmed Off for the life of the device, longevity is increased by approximately 2 months.
- When Patient Triggered Monitor is programmed to On for 60 days, longevity is reduced by approximately 5 days.
- One hour of additional ZIP wandless telemetry reduces longevity by approximately 9 days.
- Five patient-initiated LATITUDE Communicator interrogations per week for a year reduces longevity by approximately 39 days.
- For Extended Longevity (EL) devices, an additional maximum-energy shock reduces longevity by approximately 21 days.
- For MINI devices, an additional maximum-energy shock reduces longevity by approximately 23 days.
- An additional 6 months in Storage mode prior to implant will reduce longevity by 54 days. Assumes implanted settings of 60 ppm LRL, 2.5 V pacing pulse Amplitude and 0.4 ms pacing Pulse Width; 500 Ω pacing Impedance; 50% pacing.

Device longevity may also be affected by:

- Tolerances of electronic components
- Variations in programmed parameters

- Variations in usage as a result of patient condition

The following longevity tables and conditions of use apply to INCEPTA, ENERGEN, PUNCTUA, and TELIGEN devices.

Projected longevity is calculated assuming 5 maximum energy charging cycles per year, including automatic capacitor re-forms and therapeutic shocks. For the final year of device service, an additional 4 charging cycles are assumed to account for additional automatic capacitor re-forms as the device approaches the Explant indicator. These calculations also assume 3-channel EGM Onset is on and that the pulse generator spends 6 months in Storage mode during shipping and storage.

Table 18. Pulse generator life expectancy estimation (implant to explant) with ENDURALIFE battery

All Models ^{a b}						
Pacing	Longevity (years) at 500 Ω, 700 Ω, and 900 Ω Pacing Impedance (RV)					
	500 Ω		700 Ω		900 Ω	
	VR	DR	VR	DR	VR	DR
0%	10.8	10.3	10.8	10.3	10.8	10.3
15%	10.4	9.7	10.5	9.7	10.5	9.8

Table 18. Pulse generator life expectancy estimation (implant to explant) with ENDURALIFE battery (continued)

All Models ^{a b}						
Pacing	Longevity (years) at 500 Ω, 700 Ω, and 900 Ω Pacing Impedance (RV)					
	500 Ω		700 Ω		900 Ω	
	VR	DR	VR	DR	VR	DR
50%	10.1	9.2	10.2	9.3	10.3	9.3
100%	9.6	8.4	9.8	8.7	10.0	8.7

- a. For RF-enabled models, assumes ZIP telemetry use for 1 hour at implant and for 40 minutes annually for in-clinic follow-up checks.
- b. Assumes standard use of the LATITUDE Communicator as follows: Daily Device Check on, Weekly Device Alert on, weekly scheduled remote follow ups, and quarterly patient-initiated interrogations.

NOTE: *The energy consumption in the longevity table is based upon theoretical electrical principles and verified via bench testing only.*

The pulse generator longevity may increase with a decrease in any of the following:

- Pacing rate
- Pacing pulse amplitude(s)
- Pacing pulse width(s)
- Percentage of paced to sensed events

- Charging frequency

Longevity is also affected in the following circumstances:

- A decrease in pacing impedance may reduce longevity.
- When the Respiratory Sensor is programmed Off for the life of the device, longevity is increased by approximately 3 months.
- When Patient Triggered Monitor is programmed to On for 60 days, longevity is reduced by approximately 5 days
- For models with ZIP wandless telemetry, one hour of additional telemetry reduces longevity by approximately 7 days.
- Five patient-initiated LATITUDE Communicator interrogations per week for a year reduces longevity by approximately 14 days
- An additional maximum-energy shock reduces longevity by approximately 19 days.
- An additional 6 months in Storage mode prior to implant will reduce longevity by 66 days. Assumes implanted settings of 60 ppm LRL, 2.5 V pacing pulse Amplitude and 0.4 ms pacing Pulse Width; 500 Ω pacing Impedance; 50% pacing.

Device longevity may also be affected by:

- Tolerances of electronic components
- Variations in programmed parameters
- Variations in usage as a result of patient condition

WARRANTY INFORMATION

A limited warranty certificate for the pulse generator is available at www.bostonscientific.com. For a copy, contact Boston Scientific using the information on the back cover.

PRODUCT RELIABILITY

It is Boston Scientific's intent to provide implantable devices of high quality and reliability. However, these devices may exhibit malfunctions that may result in lost or compromised ability to deliver therapy. These malfunctions may include the following:

- Premature battery depletion
- Sensing or pacing issues
- Inability to shock
- Error codes
- Loss of telemetry

Refer to Boston Scientific's CRM Product Performance Report on www.bostonscientific.com for more information about device performance, including the types and rates of malfunctions that these devices have experienced historically. While historical data may not be predictive of future device performance, such data can provide important context for understanding the overall reliability of these types of products.

Sometimes device malfunctions result in the issuance of product advisories. Boston Scientific determines the need to issue product advisories based on the estimated malfunction rate and the clinical implication of the malfunction. When Boston Scientific communicates product advisory information, the decision whether to replace a device should take into account the risks of the malfunction, the risks of the replacement procedure, and the performance to date of the replacement device.

PATIENT COUNSELING INFORMATION

The following topics should be discussed with the patient prior to discharge.

- External defibrillation—the patient should contact their physician to have their pulse generator system evaluated if they receive external defibrillation
- Beeping tones—the patient should contact their physician immediately if they hear tones coming from their pulse generator

- Signs and symptoms of infection
- Symptoms that should be reported (e.g., sustained high-rate pacing requiring reprogramming)
- Protected environments—the patient should seek medical guidance before entering areas protected by a warning notice that prevents entry by patients who have a pulse generator
- Avoiding potential sources of EMI in home, work, and medical environments
- Persons administering CPR—the presence of voltage (tingling) on the patient's body surface may be experienced when the pulse generator delivers a shock
- Reliability of their pulse generator ("Product Reliability" on page 52)
- Activity restrictions (if applicable)
- Minimum heart rate (lower rate limit of the pulse generator)
- Frequency of follow up
- Travel or relocation—Follow-up arrangements should be made in advance if the patient is leaving the country of implant
- Patient ID card—the patient should be advised to carry their patient ID card at all times (a temporary patient ID card is provided with the device, and a permanent ID card will be sent to the patient 4 to 6 weeks after the implant form is received by Boston Scientific)

Patient Handbook

The Patient Handbook is provided for each device.

It is recommended that you discuss the information in the Patient Handbook with concerned individuals both before and after implantation so they are fully familiar with pulse generator operation.

For additional copies, contact Boston Scientific using the information on the back cover.

LEAD CONNECTIONS

Lead connections are illustrated below.

CAUTION: Prior to implantation, confirm the lead-to-pulse generator compatibility. Using incompatible leads and pulse generators can damage the connector and/or result in potential adverse consequences, such as undersensing of cardiac activity or failure to deliver necessary therapy.

The following lead connections apply to AUTOGEN, DYNAGEN, INOGEN, and ORIGEN devices.

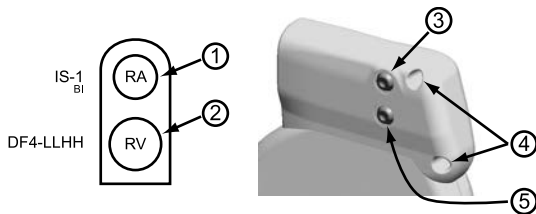

[1] RA: White [2] RV: Red [3] RA (-) [4] Suture Holes [5] RV (-)

Figure 2. Lead connections and setscrew locations, RA: IS-1, RV: DF4-LLHH

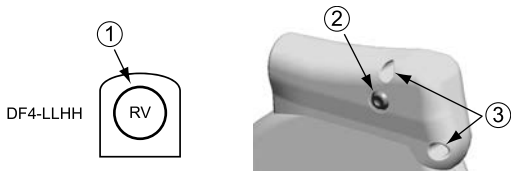

[1] RV: Red [2] RV (-) [3] Suture Holes

Figure 3. Lead connections and setscrew locations, RV: DF4-LLHH

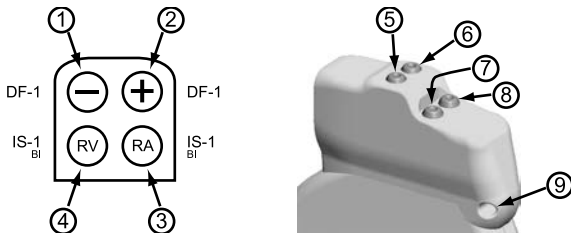

[1] Defib (-): Red [2] Defib (+): Blue [3] RA: White [4] RV: White [5] Defib (+) [6] Defib (-) [7] RA (-) [8] RV (-) [9] Suture Hole

Figure 4. Lead connections and setscrew locations, RA: IS-1, RV: IS-1/DF-1

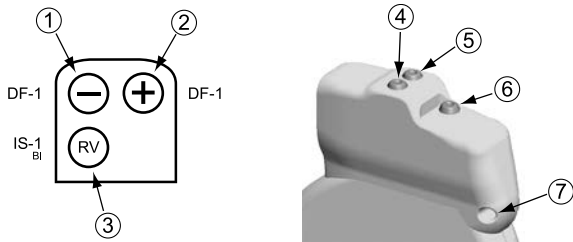

[1] Defib (-): Red [2] Defib (+): Blue [3] RV: White [4] Defib (+) [5] Defib (-) [6] RV (-) [7] Suture Hole

Figure 5. Lead connections and setscrew locations, RV: IS-1/DF-1

The following lead connections apply to INCEPTA, ENERGEN, PUNCTUA, and TELIGEN devices.

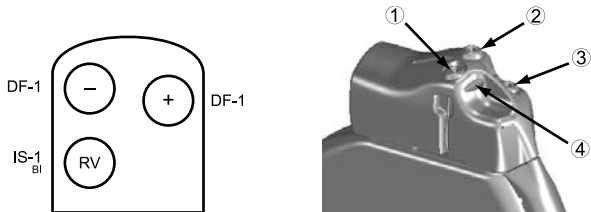

[1] Defib (+) [2] Defib (-) [3] RV (-) [4] Suture Hole

Figure 6. Lead connections and setscrew locations, RV: IS-1/DF-1

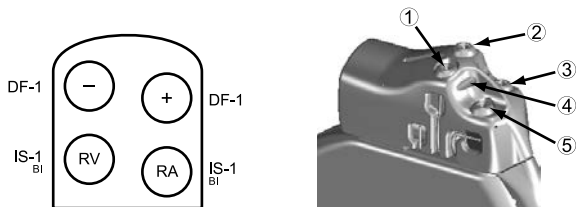

[1] Defib (+) [2] Defib (-) [3] RV (-) [4] Suture Hole [5] RA (-)

Figure 7. Lead connections and setscrew locations, RA: IS-1, RV: IS-1/DF-1

The following lead connections apply to INCEPTA, ENERGEN, and PUNCTUA devices.

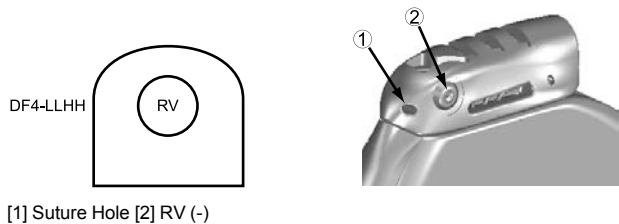

Figure 8. Lead connections and setscrew locations, RV: DF4-LLHH

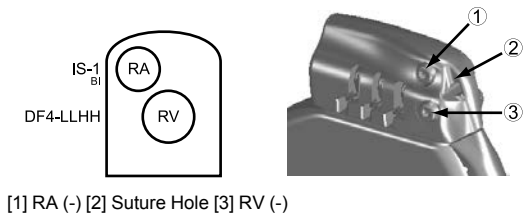

Figure 9. Lead connections and setscrew locations, RA: IS-1, RV: DF4-LLHH

NOTE: *The pulse generator case is used as a defibrillating electrode unless the pulse generator has been programmed to the Distal Coil to Proximal Coil (or “Cold Can”) Shock Vector.*

IMPLANTING THE PULSE GENERATOR

Implant the pulse generator by performing the following steps in the sequence provided. Some patients may require pacing therapies immediately upon connecting the leads to the pulse generator. In such cases, consider programming the pulse generator before or in parallel with implanting the lead system and forming the implantation pocket.

Step A: Check Equipment

It is recommended that instrumentation for cardiac monitoring, defibrillation, and lead signal measurement should be available during the implant procedure. This includes the PRM system with its related accessories and the software application. Before beginning the implantation procedure, become completely familiar with the operation of all the equipment and the information in the respective operator's and user's manuals. Verify the operational status of all equipment that may be used during the procedure. In case of accidental damage or contamination, the following should be available:

- Sterile duplicates of all implantable items
- Sterile wand
- Sterile PSA cables
- Torque and non-torque wrenches

During the implantation procedure, always have a standard external defibrillator with external pads or paddles available for use during defibrillation threshold testing.

Step B: Interrogate and Check the Pulse Generator

The PRM communicates with the pulse generator using a telemetry wand. After initiating communication with the wand, the PRM can use wandless ZIP telemetry (two-way RF communication) to interface with RF capable

pulse generators. Telemetry is required to direct commands from the PRM system, modify device parameter settings and conduct diagnostics tests.

For additional technical specifications regarding telemetry function, refer to "Federal Communications Commission (FCC)" on page 42.

To maintain sterility, test the pulse generator as described below before opening the sterile blister tray. The pulse generator should be at room temperature to ensure accurately measured parameters.

1. Interrogate the pulse generator using the PRM. Verify that the pulse generator's Tachy Mode is programmed to Storage. If otherwise, contact Boston Scientific using the information on the back cover.

To begin a ZIP telemetry session for AUTOGEN, DYNAGEN, INOGEN, and ORIGEN devices, verify that the ZOOM Wireless Transmitter is connected to the PRM via the USB cable and that the green light on top of the transmitter is illuminated. To initiate communication with all devices, position the wand over the PG and use the PRM to Interrogate the pulse generator. Keep the telemetry wand in position until either a message appears, indicating that the telemetry wand may be removed from proximity of the pulse generator, or the ZIP telemetry light illuminates on the PRM system. Select the End Session button to quit a telemetry session and return to the startup screen. Radio frequency interference may temporarily disrupt ZIP telemetry communication. Increasing the distance from the source of interfering signals or repositioning the ZOOM Wireless Transmitter may improve ZIP telemetry performance. If ZIP telemetry performance is not satisfactory, the option of using wanded telemetry is available.

2. Perform a manual capacitor re-formation.
3. Review the pulse generator's current battery status. Counters should be at zero. If the pulse generator battery status is not at full capacity, do not implant the pulse generator. Contact Boston Scientific using the information on the back cover.

Step C: Implant the Lead System

The pulse generator requires a lead system for sensing, pacing, and delivering shocks. The pulse generator can use its case as a defibrillating electrode.

Selection of lead configuration and specific surgical procedures is a matter of professional judgment. The following leads are available for use with the pulse generator depending on the device model.

- Bipolar endocardial cardioversion/defibrillation and pacing lead system
- Ventricular endocardial bipolar lead
- Atrial bipolar lead
- Superior vena cava lead coupled with a ventricular patch lead
- Two-patch epicardial leads configuration

CAUTION: The absence of a lead or plug in a lead port may affect device performance. If a lead is not used, be sure to properly insert a plug in the unused port, and then tighten the setscrew onto the plug.

CAUTION: Do not suture directly over the lead body, as this may cause structural damage. Use the suture sleeve to secure the lead proximal to the venous entry site to prevent lead movement.

Whichever lead configuration is used for both pacing/sensing and defibrillating, several considerations and cautions should be heeded. Factors such as cardiomegaly or drug therapy may necessitate repositioning of the defibrillating leads or substituting one lead for another to facilitate arrhythmia conversion. In some instances, no lead configuration may be found that provides reliable arrhythmia termination at energy levels available from the pulse generator. Implantation of the pulse generator is not recommended in these cases.

Implant the leads via the surgical approach chosen.

NOTE: *Should lead performance changes occur which cannot be resolved with programming, the lead may need to be replaced if no adapter is available.*

Step D: Take Baseline Measurements

Once the leads are implanted, take baseline measurements. Evaluate the lead signals. If performing a pulse generator replacement procedure, existing leads should be reevaluated, (e.g., signal amplitudes, pacing

thresholds, and impedance). The use of radiography may help ensure lead position and integrity. If testing results are unsatisfactory, lead system repositioning or replacement may be required.

- Connect the pace/sense lead(s) to a pacing system analyzer (PSA).

WARNING: For leads that require the use of a Connector Tool, use caution handling the lead terminal when the Connector Tool is not present on the lead. Do not directly contact the lead terminal with any surgical instruments or electrical connections such as PSA (alligator) clips, ECG connections, forceps, hemostats, and clamps. This could damage the lead terminal, possibly compromising the sealing integrity and result in loss of therapy or inappropriate therapy, such as a short within the header.

- Pace/sense lead measurements, measured approximately 10 minutes after initial placement (acute) or during a replacement procedure (chronic), are listed below. Values other than what are suggested in the table may be clinically acceptable if appropriate sensing can be documented with the currently programmed values. Consider reprogramming the sensitivity parameter if inappropriate sensing is observed. Note that the pulse generator measurements may not exactly correlate to the PSA measurements due to signal filtering.

Table 19. Lead measurements

	Pace/ sense lead (acute)	Pace/ sense lead (chronic)	Shocking lead (acute and chronic)
R-Wave Amplitude ^{a b}	> 5 mV	> 5 mV	> 1.0 mV
P-Wave Amplitude ^{a b}	> 1.5 mV	> 1.5 mV	
R-Wave Duration ^{b c d}	< 100 ms	< 100 ms	
Pacing Threshold (right ventricle)	< 1.5 V endocardial < 2.0 V epicardial	< 3.0 V endocardial < 3.5 V epicardial	

Table 19. Lead measurements (continued)

	Pace/ sense lead (acute)	Pace/ sense lead (chronic)	Shocking lead (acute and chronic)
Pacing Threshold (atrium)	< 1.5 V endocardial	< 3.0 V endocardial	
Lead impedance (at 5.0 V and 0.5 ms atrium and right ventricle) ^e	> programmed Low Impedance Limit ^f < programmed High Impedance Limit ^g	> programmed Low Impedance Limit ^f < programmed High Impedance Limit ^g	> 20 Ω < programmed High Impedance Limit (125–200 Ω)

- Amplitudes less than 2 mV cause inaccurate rate counting in the chronic state, and result in inability to sense a tachyarrhythmia or the misinterpretation of a normal rhythm as abnormal.
- Lower R-wave amplitudes and longer duration may be associated with placement in ischemic or scarred tissues. Since signal quality may deteriorate chronically, efforts should be made to meet the above criteria by repositioning the leads to obtain signals with the largest possible amplitude and shortest duration.
- Durations longer than 135 ms (the pulse generator's refractory period) may result in inaccurate cardiac rate determination, inability to sense a tachyarrhythmia, or in the misinterpretation of a normal rhythm as abnormal.
- This measurement is not inclusive of current of injury.
- Changes in the defibrillation electrode surface area, such as changing from a triad configuration to a single coil configuration, can affect the impedance measurements. Baseline defibrillation impedance measurements should fall within the recommended values indicated in the table.
- The Low Impedance Limit is programmable between 200–500 Ω .
- The High Impedance Limit is programmable between 2000 Ω and either 2500 or 3000 Ω depending on the pulse generator model.

If the lead integrity is in question, standard lead troubleshooting tests should be used to assess the lead system integrity. Troubleshooting tests include, but are not limited to, the following:

- Electrogram analysis with pocket manipulation
- X-ray or fluoroscopic image review
- Additional maximum-energy shocks
- Programming the Shock Lead Vector
- Wireless ECG
- Invasive visual inspection

Step E: Form the Implantation Pocket

Using standard operating procedures to prepare an implantation pocket, choose the position of the pocket based on the implanted lead configuration and the patient's body habitus. Giving consideration to patient anatomy and pulse generator size and motion, gently coil any excess lead and place adjacent to the pulse generator. It is important to place the lead into the pocket in a manner that minimizes lead tension, twisting, sharp angles, and/or pressure. Pulse generators are typically implanted subcutaneously in order to minimize tissue trauma and facilitate explant. However, deeper implantation (e.g., subpectoral) may help avoid erosion or extrusion in some patients.

If an abdominal implant is suitable, it is recommended that implantation occur on the left abdominal side.

If it is necessary to tunnel the lead, consider the following:

WARNING: For leads that require the use of a Connector Tool, use caution handling the lead terminal when the Connector Tool is not present on the lead. Do not directly contact the lead terminal with any surgical instruments or electrical connections such as PSA (alligator) clips, ECG connections, forceps, hemostats, and clamps. This could damage the lead terminal, possibly compromising the sealing integrity and result in loss of therapy or inappropriate therapy, such as a short within the header.

WARNING: Do not contact any other portion of the DF4–LLHH or DF4–LLHO lead terminal, other than the terminal pin, even when the lead cap is in place.

- If a compatible tunneler is not used, cap the lead terminal pins. A Penrose drain, large chest tube, or tunneling tool may be used to tunnel the leads.
- For DF4-LLHH or DF4-LLHO leads, if a compatible tunneling tip and/or tunneler kit is not used, cap the lead terminal and grip only the terminal pin with a hemostat or equivalent.
- Gently tunnel the leads subcutaneously to the implantation pocket, if necessary.
- Reevaluate all lead signals to determine if any of the leads have been damaged during the tunneling procedure.

If the leads are not connected to a pulse generator at the time of lead implantation, they must be capped before closing the incision.

Step F: Connect the Leads to the Pulse Generator

To connect leads to the pulse generator, use only the tools provided in the pulse generator sterile tray or accessory kit. Failure to use the supplied torque wrench may result in damage to the setscrews, seal plugs, or connector threads. Do not implant the pulse generator if the seal plugs appear to be damaged. Retain the tools until all testing procedures are complete and the pulse generator is implanted.

NOTE: *Some patients may require pacing therapies immediately upon connecting the leads to the pulse generator. In such cases, consider programming the pulse generator before continuing.*

Leads should be connected to the pulse generator in the following sequence (for pulse generator header and setscrew location illustrations, refer to "Lead Connections" on page 54):

1. **Right ventricle.** Connect the RV lead first because it is required to establish RV-based timing cycles that yield appropriate sensing and pacing in all chambers, regardless of the programmed configuration.

- In models with an IS-1 RV lead port, insert and secure the terminal pin of an IS-1 RV pace/sense lead.
- In models with a DF4-LLHH RV lead port, insert and secure the terminal pin of a DF4-LLHH or DF4-LLHO lead.

2. **Right atrium.**

- In models with an IS-1 RA lead port, insert and secure the terminal pin of an IS-1 atrial pace/sense lead.

3. **Defibrillation lead.**

- In models with DF-1 lead ports, first insert and secure the defibrillation lead anode (+, proximal) into the (+) DF-1 lead port. Then insert and secure the lead cathode (–, distal) into the (–) DF-1 lead port.

CAUTION: For IS-1/DF-1 leads, never change the shock waveform polarity by physically switching the lead anodes and cathodes in the pulse generator header—use the programmable Polarity feature. Device damage or nonconversion of the arrhythmia post-operatively may result if the polarity is switched physically.

Connect each lead to the pulse generator by following these steps (for additional information about the torque wrench, refer to "Bidirectional Torque Wrench" on page 80):

1. Check for the presence of any blood or other body fluids in the lead ports on the pulse generator header. If fluid inadvertently enters the ports, clean them thoroughly with sterile water.
2. If applicable, remove and discard the tip protection before using the torque wrench.
3. Gently insert the torque wrench blade into the setscrew by passing it through the preslit, center depression of the seal plug at a 90° angle (Figure 10 Inserting the torque wrench on page 67). This will open up the seal plug, relieving any potential pressure build-up from the lead port by providing a pathway to release trapped fluid or air.

NOTE: Failure to properly insert the torque wrench in the preslit depression of the seal plug may result in damage to the plug and its sealing properties.

CAUTION: Do not insert a lead into the pulse generator connector without taking the following precautions to ensure proper lead insertion:

- Insert the torque wrench into the preslit depression of the seal plug before inserting the lead into the port, to release any trapped fluid or air.
- Visually verify that the setscrew is sufficiently retracted to allow insertion. Use the torque wrench to loosen the setscrew if necessary.
- Fully insert each lead into its lead port and then tighten the setscrew onto the terminal pin.

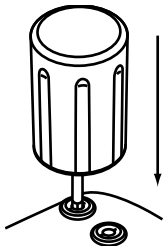

Figure 10. Inserting the torque wrench

4. With the torque wrench in place, fully insert the lead terminal into the lead port. The lead terminal pin should be clearly visible beyond the connector block when viewed through the side of the pulse generator

header. Place pressure on the lead to maintain its position and ensure that it remains fully inserted in the lead port.

CAUTION: Insert the lead terminal straight into the lead port. Do not bend the lead near the lead-header interface. Improper insertion can cause insulation or connector damage.

NOTE: *If necessary, lubricate the lead connectors sparingly with sterile water to make insertion easier.*

NOTE: *For IS-1 leads, be certain that the terminal pin visibly extends beyond the connector block at least 1 mm.*

NOTE: *For DF4-LLHH or DF4-LLHO leads, the terminal pin must be inserted beyond the setscrew block to enable a proper connection. Visualization of the terminal pin insertion indicator beyond the setscrew block may be used to confirm that the terminal pin is fully inserted into the lead port.*

5. Apply gentle downward pressure on the torque wrench until the blade is fully engaged within the setscrew cavity, taking care to avoid damage to the seal plug. Tighten the setscrew by slowly turning the torque wrench clockwise, until it ratchets once. The torque wrench is preset to apply the proper amount of force to the captive setscrew; additional rotation and force is unnecessary.
6. Remove the torque wrench.
7. Apply gentle traction to the lead to ensure a secure connection.
8. If the lead terminal is not secure, attempt to reseal the setscrew. Reinsert the torque wrench as described above, and loosen the setscrew by slowly turning the wrench counterclockwise, until the lead is loose. Then repeat the sequence above.
9. If a lead port is not used, insert a plug into the unused port and tighten the setscrew.

CAUTION: The absence of a lead or plug in a lead port may affect device performance. If a lead is not used, be sure to properly insert a plug in the unused port, and then tighten the setscrew onto the plug.

Step G: Evaluate Lead Signals

1. Take the pulse generator out of power-saving Storage mode by programming the Tachy Mode to Off.

CAUTION: To prevent inappropriate shocks, ensure that the pulse generator's Tachy Mode is programmed to Off when not in use and before handling the device. For tachyarrhythmia detection and therapy, verify that the Tachy Mode is programmed to Monitor + Therapy.

2. Insert the pulse generator into the implantation pocket.
3. Evaluate the pace/sense and defibrillation lead signals by viewing the real-time EGMs and markers. The signal from the implanted defibrillation leads should be continuous and without artifact, similar to a body-surface ECG. A discontinuous signal may indicate a poor connection, lead fracture or otherwise damaged lead, or an insulation break that would necessitate lead replacement. Inadequate signals may result in failure of the pulse generator system to detect an arrhythmia, inability to deliver programmed therapy, or unnecessary delivery of therapy. Lead measurements should reflect those above (Table 19 Lead measurements on page 62).

CAUTION: Take care to ensure that artifacts from the ventricles are not present on the atrial channel, or atrial oversensing may result. If ventricular artifacts are present in the atrial channel, the atrial lead may need to be repositioned to minimize its interaction.

4. Evaluate all lead impedances.

CAUTION: If total shocking lead impedance during implant is less than 20 Ω , verify the proximal coil is not in contact with the pulse generator surface. A measurement of less than 20 Ω is an indication of a short somewhere in the system. If repeated measurements show the total shocking lead impedance is less than 20 Ω , the lead and/or pulse generator may need to be replaced.

For AUTOGEN, DYNAGEN, INOGEN, and ORIGEN devices, the High Impedance Limit is nominally set to 2000 Ω , and is programmable between 2000 and 3000 Ω in 250 Ω increments. The Low Impedance Limit is nominally set to 200 Ω , and is programmable between 200 and 500 Ω in 50 Ω increments.

For INCEPTA, ENERGEN, PUNCTUA, and TELIGEN devices, the High Impedance Limit is nominally set to 2000 Ω , and is programmable between 2000 and 2500 Ω in 250 Ω increments. The Low Impedance Limit is nominally set to 200 Ω , and is programmable between 200 and 500 Ω in 50 Ω increments.

Consider the following factors when choosing a value for the impedance limits:

- For chronic leads, historical impedance measurements for the lead, as well as other electrical performance indicators such as stability over time
- For newly implanted leads, the starting measured impedance value

NOTE: *Depending on lead maturation effects, during follow-up testing the physician may choose to reprogram the impedance limits.*

- Pacing dependence of the patient
- Recommended impedance range for the lead(s) being used, if available

The Shock Low Impedance Limit is fixed at 20 Ω . The Shock High Impedance Limit is nominally set to 125 Ω , and is programmable between 125 and 200 Ω in 25 Ω increments. Consider the following factors when choosing a value for the High Impedance Limits:

- For chronic leads, historical impedance measurements for the lead, as well as other electrical performance indicators such as stability over time
- For newly implanted leads, the starting measured impedance value

NOTE: *Depending on lead maturation effects, during follow-up testing the physician may choose to reprogram the High Impedance Limits.*

- Recommended impedance range for the lead(s) being used, if available
- The impedance value of a high or maximum energy shock impedance test

Shocking lead impedance readings between 20 Ω and the programmed High Impedance Limit are considered in-range. If abrupt or large impedance fluctuations or out-of-range conditions are observed, consider the following:

- Verify the configuration—ensure the programmed Shock Vector matches the configuration of the implanted lead (e.g., use RV Coil to Can with a single-coil lead).
- Verify the connection—ensure the shocking lead's terminal pins are placed in the correct lead ports and verify a secure lead connection.
- Verify the contact—ensure the device is inside a wet implant pocket since the pulse generator case serves as an active electrode in the V-TRIAD configuration. Avoid pocket manipulation during the test.
- Turn off sources of external noise (e.g., electrocautery equipment, monitors).
- Use other troubleshooting tools, as needed, to further assess lead system integrity, including electrogram analysis, X-ray or fluoroscopic image review, or internal visual inspection.

NOTE: *Because this device uses a subthreshold test pulse to conduct shock lead impedance measurements, it can be difficult to measure responses to test signals when electrical interference or “noise” (e.g., electrocautery or external monitoring equipment attached directly to the patient) is present during the test. This may result in impedance measurement variations, particularly at implant. In the absence of such electrical interference, shock lead impedance readings will be more stable.*

Step H: Program the Pulse Generator

1. Check the Programmer Clock and set and synchronize the pulse generator as necessary so that the proper time appears on printed reports and PRM strip chart recordings.
2. It may be useful to program the Beep During Capacitor Charge feature to On during conversion testing and implantation to help recognize when the pulse generator is charging to deliver a shock.
3. Perform a manual capacitor re-formation if not already performed.

4. Program the pulse generator appropriately if a lead port(s) is not used.
5. Program the pulse generator to desired parameters appropriate for the patient for conversion testing.

Consider the following when programming the pulse generator:

- The minimum 2X voltage or 3X pulse width safety margin is recommended for each chamber based on the capture thresholds, which should provide an adequate safety margin and help preserve battery longevity.
- When Smart Blanking is used, it is possible that polarization artifacts following atrial pacing may be detected as R-waves and inhibit ventricular pacing (after tachy therapy or high-output ventricular pacing). If the patient is pacemaker-dependent, test for proper sensing after shock therapy. If oversensing is occurring post-shock, be prepared to use the STAT PACE command.
- Programming a longer blanking period may increase the likelihood of undersensing R-waves.
- Programming a shorter blanking period may increase the likelihood for ventricular oversensing of an atrial paced event.
- To reduce the risk of ventricular undersensing due to V-Blank after A-Pace (when a dual-chamber pacing mode with Rate Smoothing or Rate Adaptive Pacing is necessary):
 - Reduce the LRL
 - Shorten the AV Delay or use Dynamic AV Delay and reduce the minimum Dynamic AV Delay setting
 - Reduce the Search AV Delay for AV Search +
 - Increase the Down Rate Smoothing percentage to the largest possible value
 - Decrease the Recovery Time for Rate Adaptive Pacing modes
 - Reduce the MTR or MPR if Down Rate Smoothing is on
 - Reduce the MSR if the pacing mode is rate adaptive

- When reprogramming the RhythmMatch Threshold value, consider the following:
 - Review the measured RhythmMatch values for previous episodes of VT and SVT (induced or spontaneous)
 - To increase the likelihood of appropriate treatment of VT, the RhythmMatch Threshold should be programmed above the measured RhythmMatch values of any VTs
 - To increase the likelihood of appropriate inhibition of therapy for SVT, the RhythmMatch Threshold should be programmed below the measured RhythmMatch values of any SVTs
 - In general, the sensitivity of VT detection declines with lower programmed RhythmMatch Threshold values, therefore for maximum sensitivity to VT, the highest appropriate RhythmMatch Threshold value should be programmed.
 - Measured RhythmMatch values may also be useful for programming other Rhythm ID parameters including Atrial Tachyarrhythmia Discrimination, AFib Rate Threshold, and Stability
- When programming MTR, consider the patient's condition, age, general health, sinus node function, and that a high MTR may be inappropriate for patients who experience angina or other symptoms of myocardial ischemia at higher rates.
- When programming MSR, consider the patient's condition, age, general health and that adaptive-rate pacing at higher rates may be inappropriate for patients who experience angina or other symptoms of myocardial ischemia at these higher rates. An appropriate MSR should be selected based on an assessment of the highest pacing rate that the patient can tolerate well.
- Programming long Atrial Refractory periods in combination with certain AV Delay periods can cause 2:1 block to occur abruptly at the programmed MTR.
- Prior to programming RVAT on, consider performing a Commanded Ventricular Automatic Threshold Measurement to verify that the feature functions as expected.

- In pacemaker-dependent patients, use care when considering setting Noise Response to Inhibit Pacing as pacing will not occur in the presence of noise.
- To resolve suspected impedance-based interactions with the Respiratory Sensor, program the sensor to Off.

CAUTION: To prevent inappropriate shocks, ensure that the pulse generator's Tachy Mode is programmed to Off when not in use and before handling the device. For tachyarrhythmia detection and therapy, verify that the Tachy Mode is programmed to Monitor + Therapy.

Step I: Test for Ability to Convert Ventricular Fibrillation and Inducible Arrhythmias

After obtaining acceptable signals from the implanted leads, the physician may choose to perform VT and VF conversion testing to determine (1) if the configuration and position of the implanted leads are appropriate for the patient and (2) if the pulse generator's programmed shock energy or maximum-shock energy will be sufficient to convert arrhythmias reliably and (3) if AGC and detection enhancements are programmed appropriately to detect VF/VT. A conversion test consists of inducing the arrhythmia and then attempting to convert the arrhythmia with a preselected energy level.

Demonstrating conversion of ventricular fibrillation is suggested before implanting a pulse generator because a shock delivered during ventricular tachycardia has the potential to accelerate the arrhythmia. Intraoperative testing may be minimized by performing only VF testing at time of implant and performing VT testing post-operatively in the electrophysiology lab prior to the patient's discharge.

If the conversion is unsuccessful, the patient should be rescued using an appropriate external defibrillator. As part of the overall clinical evaluation during conversion testing and evaluation of spontaneous episodes during follow up, ensure there is no delay or interruption in tachyarrhythmia detection and therapy delivery. Perform additional evaluation if any diversion of charging cycles or shock delivery is observed.

If conversion testing is performed, the permanently programmed parameters may be the same as those used during testing, or they may be modified to different values. The device can be programmed with the intended final parameter settings for all VT/VF (multiple zones), or with a single zone VF setting with a rate threshold

below that of any known arrhythmia. When no conversion testing is performed in patients with primary prevention indications, a physician should consider that high detection rates can limit the ability of the device to accurately detect and treat polymorphic tachyarrhythmias. It is important to evaluate the device's stored diagnostic data and EGMs, including the interval plot, after conversion testing (refer to "Tachyarrhythmia Programming Considerations" below). Programming final rate thresholds for VT/VF to higher values, or less sensitive AGC settings, than the tested parameters may result in under-detection of later spontaneous tachyarrhythmias.

WARNING: Always have external defibrillation equipment available during implant and electrophysiologic testing. If not terminated in a timely fashion, an induced ventricular tachyarrhythmia can result in the patient's death.

NOTE: *If open chest surgery is performed and a chest retractor is used, remove it before conversion testing to best simulate the ambulatory conditions in which the pulse generator will operate and to avoid potential shunting of energy.*

Induce the Patient's Arrhythmia

An arrhythmia can be induced by using the induction features of the pulse generator.

Allow the patient's blood pressure and electrophysiologic status to return to baseline between arrhythmia inductions, whether successful or unsuccessful. The minimum time between conversion tests should be based on the clinical (hemodynamic and metabolic) stability of the patient and the physician's discretion.

During each arrhythmia induction, note the heart rate to determine the appropriate rate threshold values. Ventricular cycle lengths that occur close to but below the lowest programmed rate threshold value may be detected as normal sinus rhythm. To provide sufficient opportunity for detection, the rate threshold value(s) should be programmed at least 10 bpm below the rate of the arrhythmia(s) intended to be treated.

Perform the Induction

1. Verify the pulse generator is in the implantation pocket. Temporarily close the pocket enough to ensure that the pulse generator will remain in position during conversion testing. Make sure the pulse generator

has good contact with surrounding tissue; flush the pocket with saline solution, if necessary, to avoid a dry pocket.

CAUTION: Do not allow any object that is electrically conductive to come into contact with the lead or device during induction because it may shunt energy, resulting in less energy getting to the patient, and may damage the implanted system.

2. Verify magnet function and telemetry to ensure the pulse generator is within acceptable range.
3. Program the appropriate parameters and change the pulse generator Tachy Mode to Monitor + Therapy.
4. Perform the induction using the programmer.

Testing Energy Requirements and Thresholds for Successful Defibrillation

Defibrillation energy requirements and threshold testing for successful defibrillation should be performed at implant.

Shocks intended for VF or polymorphic VT therapy should be programmed with a 10 J safety margin above the shock energy level that the physician determines is required for successful VF conversion. In some situations, an alternative safety margin (above the shock energy level required for successful VF conversion) may be determined by the physician to be adequate.

Different test methods for determining defibrillation thresholds are described in clinical literature and include, but are not limited to:

- Stepping down to failure defibrillation threshold testing to determine the DFT and verifying the last successful energy either once [1x (DFT+)] or twice [2x (DFT++)].
- Selecting the defibrillation energy requirement testing by subtracting the accepted safety margin from the device maximum output.

Defining an implantation safety margin and the relationship to the probability for success is described in clinical literature. Any result from a single test method may be an example of statistical variation, and a one-time

conversion of a rhythm disturbance at a particular energy level does not guarantee or ensure that the energy level is reliable for conversion.

As a safety margin with a 41 J system, it is recommended that the conversion test be performed at the DFT level two times if the DFT or selected energy level is 31 J, or one time if the DFT or selected energy level is 21 J with no failures to convert.

Always have a standard external defibrillator with external pads or paddles available for use during defibrillation threshold testing.

If implantation safety margin and initial conversion at 31 J is unsuccessful, consider a combination of different methods to optimize the defibrillation field and efficacy. Possibilities include, but are not limited to:

- Optimize the lead position — place the lead as apical and septal as possible to direct most of the energy to the left ventricular mass as described in clinical literature.
- Reverse polarity — use electronic device programming options to change polarity. Do not physically switch the lead anodes and cathodes in the pulse generator header.
- Reprogram the Shock Lead Vector configuration in the device (e.g., remove the proximal coil from a TRIAD configuration to a single shock vector such as the RV Coil to Can configuration).
- Add additional defibrillation coils or leads to increase the defibrillation surface area.

NOTE: Refer to Table 19 Lead measurements on page 62 for acceptable lead measurements after lead repositioning or reprogramming.

Step J: Tachyarrhythmia Programming Considerations

Detection Zones

Select the appropriate number of therapy zones (VT-1, VT, VF) to treat the expected ventricular tachyarrhythmias based on the tachyarrhythmia hemodynamic stability, patient indications, and the individual

patient clinical characteristics. To provide sufficient opportunity for detection, the rate threshold value(s) should be programmed at least 10 bpm below the rate of known arrhythmia(s) intended to be treated.

NOTE: *The device detection and subsequent therapy may be different for the same underlying tachyarrhythmia depending on the number of zones and programmed parameters such as rate threshold, detection time, and detection enhancements (if applied).*

Episode Storage Review

Device diagnostics are stored in the pulse generator and are viewable via the PRM or LATITUDE NXT. Diagnostics enable a review of device detection and response to induced and spontaneous tachyarrhythmias. Stored electrograms include an interval plot. Evaluating the interval plot helps to identify detected beats including those below the rate threshold. Beats below the programmed rate threshold may delay or inhibit device detection of a tachyarrhythmia, and consideration should be given to reprogram the rates to improve detection. Inspection of the stored electrograms, with use of the on-screen calipers for EGM amplitude and timing measurement, permits the physician to interpret whether there are ventricular beats which are not detected. If there are unmarked beats, then an assessment should occur to determine if programming slower rate zones would improve detection.

Detection and Automatic Gain Control (AGC)

The right ventricular AGC is set to a nominal value of 0.6 mV and can be adjusted using the PRM. Adjustment of the AGC may be considered for cases with low amplitude EGMs, delay in time to therapy, or per the physician's discretion in individual cases. Any adjustment of the AGC must be evaluated in combination with the programmed detection rate thresholds/zones to ensure appropriate rate detection of the expected tachyarrhythmia. The AGC may not reach its programmed floor when tachyarrhythmia detection rates are rapid and the arrhythmia is polymorphic. Always evaluate the rate of the detection zones and the AGC setting in combination using the episode storage information. If a physician examines the EGMs and believes the device is not detecting ventricular beat(s) in the appropriate zone, then reprogramming detection rate thresholds to slower rates may facilitate the overall detection behavior. Adjusting the AGC with conversion testing may be considered. Changes in the patient's metabolic state, along with prescription drugs, may affect the size of the

waveform on the EGM. AGC reprogramming may not be necessary when markers indicate device sensing is appropriate, but the sensed intervals are below the rate criteria.

Markers

Markers such as VT-1, VT, and VF, including the measured cycle length, are recorded and associated with the programmed detection zones. The presence of markers indicates that the device has detected a certain beat. Fluctuating tachycardia rates that are close to, or just below, the lowest rate threshold may be marked as VS (ventricular sense). Review of the interval plot provides an overview of the programmed rate thresholds and interval distribution during the episodes. This information enables clinical adjustment of detection parameters per the physician's discretion.

Step K: Implant the Pulse Generator

1. Program the Tachy Mode to Off.
2. Verify magnet function and wand telemetry to ensure the pulse generator is within acceptable range to initiate interrogation.
3. Ensure that the pulse generator has good contact with surrounding tissue of the implantation pocket, and then suture it in place to minimize device migration (for suture hole location illustrations, refer to "Lead Connections" on page 54). Gently coil excess lead and place adjacent to the pulse generator. Flush the pocket with saline solution, if necessary, to avoid a dry pocket.

WARNING: Do not kink, twist, or braid the lead with other leads as doing so could cause lead insulation abrasion damage or conductor damage.

4. Close the implantation pocket. Consideration should be given to place the leads in a manner to prevent contact with suture materials. It is recommended that absorbable sutures be used for closure of tissue layers.
5. Complete any electrocautery procedures before reactivating the pulse generator.
6. Program the Tachy Mode to the desired setting and confirm final programmed parameters.

CAUTION: Following any sensing range adjustment or any modification of the sensing lead, always verify appropriate sensing. Programming Sensitivity to the highest value (lowest sensitivity) may result in delayed detection or undersensing of cardiac activity. Likewise, programming to the lowest value (highest sensitivity) may result in oversensing of non-cardiac signals.

7. Use the PRM to print out parameter reports and save all patient data.

Step L: Complete and Return the Implantation Form

Within ten days of implantation, complete the Warranty Validation and Lead Registration form and return the original to Boston Scientific along with a copy of the patient data saved from the PRM. This information enables Boston Scientific to register each implanted pulse generator and set of leads, and provide clinical data on the performance of the implanted system. Keep a copy of the Warranty Validation and Lead Registration form and programmer printouts, and the original patient data for the patient's file.

Complete the temporary patient identification card and give it to the patient. After receiving the validation form, Boston Scientific sends the patient a permanent identification card.

BIDIRECTIONAL TORQUE WRENCH

A torque wrench (model 6628) is included in the sterile tray with the pulse generator, and is designed for tightening and loosening #2-56 setscrews, captured setscrews, and setscrews on this and other Boston Scientific pulse generators and lead accessories that have setscrews that spin freely when fully retracted (these setscrews typically have white seal plugs).

This torque wrench is bidirectional, and is preset to apply adequate torque to the setscrew and will ratchet when the setscrew is secure. The ratchet release mechanism prevents overtightening that could result in device damage. To facilitate the loosening of tight extended setscrews, this wrench applies more torque in the counterclockwise direction than in the clockwise direction.

NOTE: *As an additional safeguard, the tip of the torque wrench is designed to break off if used to overtighten beyond preset torque levels. If this occurs, the broken tip must be extracted from the setscrew using forceps.*

This torque wrench may also be used for loosening setscrews on other Boston Scientific pulse generators and lead accessories that have setscrews that tighten against a stop when fully retracted (these setscrews typically have clear seal plugs). However, when retracting these setscrews, stop turning the torque wrench when the setscrew has come in contact with the stop. The additional counterclockwise torque of this wrench may cause these setscrews to become stuck if tightened against the stop.

Loosening Stuck Setscrews

Follow these steps to loosen stuck setscrews:

1. From a perpendicular position, tilt the torque wrench to the side 20° to 30° from the vertical center axis of the setscrew (Figure 11 Rotating the torque wrench to loosen a stuck setscrew on page 82).
2. Rotate the wrench clockwise (for retracted setscrew) or counterclockwise (for extended setscrew) around the axis three times, such that the handle of the wrench orbits the centerline of the screw (Figure 11 Rotating the torque wrench to loosen a stuck setscrew on page 82). The torque wrench handle should not turn or twist during this rotation.
3. As needed, you may attempt this up to four times with slightly more angle each time. If you cannot fully loosen the setscrew, use the #2 torque wrench from Wrench Kit Model 6501.
4. Once the setscrew has been freed, it may be extended or retracted as appropriate.
5. Discard the torque wrench upon completion of this procedure.

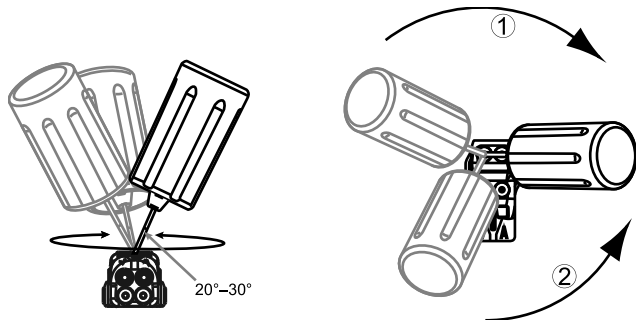

[1] Clockwise rotation to free setscrews stuck in the retracted position [2] Counterclockwise rotation to free setscrews stuck in the extended position

Figure 11. Rotating the torque wrench to loosen a stuck setscrew

FOLLOW UP TESTING

It is recommended that device functions be evaluated with periodic follow-up testing by trained personnel. Follow up guidance below will enable thorough review of device performance and associated patient health status throughout the life of the device.

WARNING: Ensure that an external defibrillator and medical personnel skilled in CPR are present during post-implant device testing should the patient require external rescue.

Predischarge Follow Up

The following procedures are typically performed during the predischarge follow up test using PRM telemetry:

1. Interrogate the pulse generator and review the Summary screen.
2. Verify pacing thresholds, lead impedance, and amplitude of intrinsic signals.
3. Review counters and histograms.
4. When all testing is complete, perform a final interrogation and save all the patient data.
5. Print the Quick Notes and Patient Data reports to retain in your files for future reference.
6. Clear the counters and histograms so that the most recent data will be displayed at the next follow up session. Counters and histograms can be cleared by pressing Reset on the Histogram screen, Tachy Counters screen, or Brady Counters screen.

Routine Follow Up

You should conduct routine follow up examinations one month after the predischarge check and every three months thereafter to evaluate device programming, therapy effectiveness, lead status, and battery status. Office visits may be supplemented by remote monitoring where available.

NOTE: *Because the duration of the device replacement timer is three months (starting when Explant status is reached), three month follow up frequency is particularly important after the One Year Remaining status is reached.*

Consider performing the following procedures during a routine follow-up test:

1. Interrogate the pulse generator and review the Summary screen.
2. Verify pacing thresholds, lead impedance, and amplitude of intrinsic signals.
3. Print the Quick Notes and Patient Data reports to retain in your files for future reference.
4. Review the Arrhythmia Logbook screen and for episodes of interest, print episode details and stored electrogram information.
5. Clear the counters and histograms so that the most recent episode data will be displayed at the next follow-up session.
6. Verify that important programmed parameter values (e.g., Lower Rate Limit, AV Delay, Rate Adaptive Pacing, output Amplitude, Pulse Width, Sensitivity, Ventricular Zones, Detection Rate) are optimal for current patient status. Refer to the steps above (“Test for Ability to Convert Ventricular Fibrillation” and “Inducible Arrhythmias and Tachyarrhythmia Programming Considerations”) for additional information on programming tachyarrhythmia detection and therapy (“Implanting the Pulse Generator” on page 59).

NOTE: *Echo-Doppler studies may be used to non-invasively evaluate AV Delay and other programming options post-implant.*

CAUTION: Successful VF or VT conversion during arrhythmia conversion testing is no assurance that conversion will occur post-operatively. Be aware that changes in the patient's condition, drug regimen, and other factors may change the DFT, which may result in nonconversion of the arrhythmia post-operatively.

EXPLANATION

NOTE: *Return all explanted pulse generators and leads to Boston Scientific. Examination of explanted pulse generators and leads can provide information for continued improvement in system reliability and warranty considerations.*

WARNING: Do not reuse, reprocess, or resterilize. Reuse, reprocessing, or resterilization may compromise the structural integrity of the device and/or lead to device failure which, in turn, may result in patient injury, illness, or death. Reuse, reprocessing, or resterilization may also create a risk of contamination of the device and/or cause patient infection or cross-infection, including, but not limited to, the transmission of infectious disease(s) from one patient to another. Contamination of the device may lead to injury, illness, or death of the patient.

Contact Boston Scientific when any of the following occur:

- When a product is removed from service.
- In the event of patient death (regardless of cause), along with an autopsy report, if performed.
- For other observation or complication reasons.

NOTE: *Disposal of explanted pulse generators and/or leads is subject to applicable laws and regulations. For a Returned Product Kit, contact Boston Scientific using the information on the back cover.*

NOTE: *Discoloration of the pulse generator may have occurred due to a normal process of anodization, and has no effect on the pulse generator function.*

CAUTION: Be sure that the pulse generator is removed before cremation. Cremation and incineration temperatures might cause the pulse generator to explode.

CAUTION: Before explanting, cleaning, or shipping the device, complete the following actions to prevent unwanted shocks, overwriting of important therapy history data, and audible tones:

- Program the pulse generator Tachy and Brady Modes to Off.
- Program the Magnet Response feature to Off.
- Program the Beep when Explant is Indicated feature to Off.
- Program the Beep When Out-of-Range feature to Off

Clean and disinfect the device using standard biohazard handling techniques.

Consider the following items when explanting and returning the pulse generator and/or lead:

- Interrogate the pulse generator and print a comprehensive report.
- Deactivate the pulse generator before explantation.
- Disconnect the leads from the pulse generator.
- If leads are explanted, attempt to remove them intact, and return them regardless of condition. Do not remove leads with hemostats or any other clamping tool that may damage the leads. Resort to tools only if manual manipulation cannot free the lead.
- Wash, but do not submerge, the pulse generator and leads to remove body fluids and debris using a disinfectant solution. Do not allow fluids to enter the pulse generator's lead ports.
- Use a Boston Scientific Returned Product Kit to properly package the pulse generator and/or lead, and send it to Boston Scientific.

Boston Scientific

For additional reference information, go to www.bostonscientific-elabeling.com.

Boston Scientific Corporation
4100 Hamline Avenue North
St. Paul, MN 55112–5798 USA

www.bostonscientific.com

1.800.CARDIAC (227.3422)
+1.651.582.4000

© 2016 Boston Scientific Corporation or its affiliates.
All rights reserved.

359403-003 EN US 2016-05

