

Endoscopy Product Catalogue

Boston Scientific
Advancing science for life™

Produktkatalog – Catalogue Produits
Catálogo de Productos – Catalogo dei Prodotti

2015

INSTRUCTIONS for iPad users

To use the full functionality of this interactive Endoscopy catalogue, please follow the instructions:



Tap and hold on PDF, then tap on
[Open in "iBooks"](#)



For single use only. Do not reuse.

Updated 02/2015



Contents



Alphabetical
Index

Product Code
Index

Contents

RX Biliary System™

Cannulas	Tandem™ RX Cannula	2
	RX Cannulas	2
Sphincterotomes	Hydratome™ RX Cannulating Sphincterotomes with Pre-loaded Hydra Jagwire™ Guidewire	3
	Dreamtome™ RX Cannulating Sphincterotomes with Pre-loaded Dreamwire™ Guidewire	3
	Jagtome™ RX Cannulating Sphincterotomes with Pre-loaded Jagwire™ Guidewire	4
	Autotome™ RX Cannulating Sphincterotomes	5
	RX Triple-lumen Needleknife	5
Stone Retrieval	Extractor™ Pro RX Triple-lumen Retrieval Balloons – Distal Injection	6
	Extractor™ Pro RX Triple-lumen Retrieval Balloons – Proximal Injection	6
	Trapezoid™ RX Wire-guided Retrieval Baskets	6
Dilation	Hurricane™ RX Biliary Dilation Balloons	7
Cytology	RX Cytology Brush	7
Accessories	RX Accessories	8
	Encore™ 26 Inflation Device	8

Biliary

Cannulas	Tandem™ XL Triple-lumen ERCP Cannula	10
	Contour™ ERCP Cannulas	10
	Fluoro Tip™ ERCP Cannulas	11
Sphincterotomes	Stonetome™ Stone Removal Device	11
	TRUEtome™ Jag Cannulating Sphincterotomes with Pre-loaded Jagwire™ Guidewire	12
	TRUEtome™ Dreamwire Cannulating Sphincterotomes with Pre-loaded Dreamwire™ Guidewire	12
	TRUEtome™ Hydra Cannulating Sphincterotomes with Pre-loaded Hydra Jagwire™ Guidewire	12
	TRUEtome™ Cannulating Sphincterotomes	13
	Ultratome XL™ Triple-lumen Wire-guided Sphincterotomes	14
	Ultratome™ Double-lumen Wire-guided Sphincterotomes	14
	Microknife™ XL Triple-lumen Needleknife	14
Stone Retrieval	Extractor™ Pro XL Triple-lumen Retrieval Balloons – Distal Injection	15
	Extractor™ Pro XL Triple-lumen Retrieval Balloons – Proximal Injection	15
	Extractor™ Pro DL Double-lumen Retrieval Balloons	15
Dilation	Max Force™ Biliary Dilation Balloons	16
Accessories	Biliary Accessories	16

SpyGlass™ Direct Visualisation Systems

SpyGlass™ DS	SpyGlass™ DS Capital Equipment	18
	SpyGlass™ DS Disposable Equipment	18
SpyGlass™	SpyGlass™ Capital Equipment	19
	SpyGlass™ Reusable Equipment	19
	SpyGlass™ Disposable Equipment	19
	SpyGlass™ Optional Accessories	19

Contents (CONTINUED)

Endoscopic Ultrasound (EUS)

Fine Needle Aspiration (FNA)	Expect™ Standard Handle Needles	21
	Expect™ Slimline Handle Needles	21

Stents

RX Biliary Metal Stents	WallFlex™ Biliary RX Fully Covered Stents with Permalume™ Covering (including benign indication)	23
	WallFlex™ Biliary RX Partially Covered Stents with Permalume™ Covering	23
	WallFlex™ Biliary RX Non-covered Stents	24
	Wallstent™ RX Biliary Stents with Permalume™ Covering	25
	Wallstent™ RX Biliary Stents	25
Biliary Metal Stents	Wallstent™ Biliary Stents with Permalume™ Covering	26
	Wallstent™ Biliary Stents	26
RX Biliary Plastic Stents	Advanix™ Pre-loaded RX Stents with NaviFlex™ RX Delivery System	27
	Advanix™ Stents – Singles	28–29
	NaviFlex™ RX Delivery System	29
	RX Biliary Plastic Stents	30
Biliary Plastic Stents	Flexima™ Biliary Stents	31
	Flexima™ Nasobiliary Stents	31
	Percuflex™ Amsterdam Biliary Stents	32
	Percuflex™ Amsterdam Introducer Kits	32
	C-flex™ Pigtail Biliary Stents	32
Pancreatic Plastic Stents	Advanix™ Pancreatic Stent Kits (Stent + RX Pusher) – Pigtail	33
	Advanix™ Pancreatic Stent Kits (Stent + RX Pusher) – Straight	33
	Advanix™ Pancreatic Single Stents – Pigtail	34–35
	Advanix™ Pancreatic Single Stents – Straight	35–37
	NaviFlex™ RX Pancreatic Delivery System & NaviFlex Pushers	38
Esophageal Stents	WallFlex™ Fully Covered Esophageal Stents with Permalume™ Covering (including benign indication)	39
	WallFlex™ Partially Covered Esophageal Stents with Permalume™ Covering	39
	Ultraflex™ Covered Esophageal NG Stents – Proximal Release	40
	Ultraflex™ Covered Esophageal NG Stents – Distal Release	40
	Ultraflex™ Non-covered Esophageal NG Stents – Proximal Release	40
	Ultraflex™ Non-covered Esophageal NG Stents – Distal Release	40
	Polyflex Stent™ Self-expanding Silicone Esophageal Stents	41
Colonic and Duodenal Stents	WallFlex™ Colonic Stents	42
	WallFlex™ Duodenal Stents	42
	Wallstent™ Colonic and Duodenal Stents	43
	Ultraflex Precision™ Colonic Stents	43
While in Stock	WallFlex™ Biliary RX Fully Covered Stents with Permalume™ Covering	44
	WallFlex™ Fully Covered Esophageal Stents with Permalume™ Covering	44



Contents (CONTINUED)

Dilation

CRE™ Controlled Radial Expansion Dilation Balloons	CRE™ Wireguided Esophageal/Pyloric/Biliary Dilation Balloons (including DASE indication)	46
	CRE™ Wireguided Esophageal/Pyloric/Colonic/Biliary Dilation Balloons (including DASE indication)	46
	CRE™ Fixed Wire Dilation Balloons	47
Max Force™ TTS Dilation Balloons	Max Force™ TTS Esophageal Dilation Balloons	48
	Rigiflex™ II Achalasia Dilation Balloons	48
Inflation Systems	Alliance™ II Inflation System	49
Dilation Accessories	Inflation/Deflation Devices and Accessories	49
While in Stock	CRE™ Wireguided Esophageal/Pyloric Dilation Balloons	50
	CRE™ Wireguided Esophageal/Pyloric/Colonic Dilation Balloons	50

Guidewires

High Performance	Dreamwire™ High Performance Guidewires	52
	Hydra Jagwire™ High Performance Guidewires	52
	Jagwire™ High Performance Guidewires	53
	Jagwire™ High Performance Guidewires – Extendable Jagwire	53
	NaviPro™ 100% Hydrophilic Guidewires	54
Exchange	Pathfinder™ Exchange Guidewire	54
Standard	Amplatz™ Super Stiff Guidewire	54
	Wallstent™ Super Stiff Guidewire	54

Hemostasis

Clipping Devices	Resolution™ Clip	56
Multiple Band Ligators	Speedband Superview Super 7™ Multiple Band Ligators	56
Bipolar Electrohemostasis Catheters	Injection Gold Probe™ Electrohemostasis/Injection Catheters	57
	Gold Probe™ Electrohemostasis Catheters	57
Needles	Interject™ Sclerotherapy Needles	58
	Interject™ Clear Sclerotherapy Needles	58
	Optiflo™ Hemostasis Catheters	59
Electrosurgical Bipolar Cable Adaptors	Electrosurgical Bipolar Cable Adaptors	59

Polypectomy

Snares	Rotatable Snares	61
	Sensation™ Short Throw Snares	61
	Captiflex™ Snares	62
	Captivator™ Snares	62
	Captivator™ II Snares	63
	Profile™ Pediatric Snares	63
Hot Biopsy Forceps	Radial Jaw™ 4 Hot Biopsy Forceps	64
Polyp Retrieval Devices	TWISTER® PLUS Rotatable Retrieval Device	64
	Active Cords	64



Contents (CONTINUED)

Biopsy

Forceps	Radial Jaw™ 4 Standard Capacity Biopsy Forceps	66
	Radial Jaw™ 4 Large Capacity Biopsy Forceps	66
	Radial Jaw™ 4 Jumbo Biopsy Forceps	67
	Radial Jaw™ 4 Gastropediatric Biopsy Forceps	67
	Multibite™ Multiple Sample Biopsy Forceps	67

Enteral Feeding

Initial Placement	Standard PEGs	69
	PEG/Replacement PEG Accessories	69
	One Step Button Low Profile PEG Kits	69
	One Step Button and Low Profile Button Accessories	70
	Through-The-PEG (TTP) Jejunal Feeding Tube	70
Replacements	Recommended Anchoring Device	70
	Standard Balloon Replacements	71
	Low Profile Button Replacements	71

Pulmonary

Alair™ Bronchial Thermoplasty (BT) System	Alair™ Bronchial Thermoplasty (BT) System	73
	Alair™ BT Controller Accessory Kits ATS 201	73
Airway Stents	Dynamic™ (Y) Stents	74
	Ultraflex™ Covered Tracheobronchial NG Stents – Distal Release – Tracheal Stents	74
	Ultraflex™ Covered Tracheobronchial NG Stents – Distal Release – Bronchial Stents	74
	Ultraflex™ Non-covered Tracheobronchial NG Stents – Proximal Release – Tracheal Stents	75
	Ultraflex™ Non-covered Tracheobronchial NG Stents – Proximal Release – Bronchial Stents	75
	Ultraflex™ Non-covered Tracheobronchial NG Stents – Distal Release – Tracheal Stents	75
	Ultraflex™ Non-covered Tracheobronchial NG Stents – Distal Release – Bronchial Stents	75
	Polyflex Stent™ Self-expanding Silicone Airway Stents	76
Biopsy Forceps	Radial Jaw™ 4 Pulmonary Biopsy Forceps	77
Transbronchial Aspiration Needles	eXcelon™ Transbronchial Aspiration Needle with Syringe	77
Cytology Brushes	Celebrity™ Endoscopic Cytology Brushes – Bronchoscope	77
Airway Retrieval Baskets	ZeroTip™ Airway Retrieval Baskets	78
Dilation Balloons	CRE™ Pulmonary Dilation Balloons	78
Guidewires	Jagwire™ Pulmonary Guidewire	78
Inflation System	Alliance™ II Inflation System	79



Alphabetical Index

Active Cords	64
Advanix™ Pancreatic Single Stents – Pigtail	34–35
Advanix™ Pancreatic Single Stents – Straight	35–37
Advanix™ Pancreatic Stent Kits (Stent + RX Pusher) – Pigtail	33
Advanix™ Pancreatic Stent Kits (Stent + RX Pusher) – Straight	33
Advanix™ Pre-loaded RX Stents with NaviFlex™ RX Delivery System	27
Advanix™ Stents – Singles	28–29
Alair™ Bronchial Thermoplasty (BT) System	73
Alair™ BT Controller Accessory Kits ATS 201	73
Alliance™ II Inflation System	49, 79
Amplatz™ Super Stiff Guidewire	54
Autotome™ RX Cannulating Sphincterotomes	5
Biliary Accessories	16
C-flex™ Pigtail Biliary Stents	32
Captiflex™ Snares	62
Captivator™ II Snares	63
Captivator™ Snares	62
Celebrity™ Endoscopic Cytology Brushes – Bronchoscope	77
Contour™ ERCP Cannulas	10
CRE™ Fixed Wire Dilation Balloons	47
CRE™ Pulmonary Dilation Balloons	78
CRE™ Wireguided Esophageal/Pyloric Dilation Balloons	50
CRE™ Wireguided Esophageal/Pyloric/Biliary Dilation Balloons (including DASE indication)	46
CRE™ Wireguided Esophageal/Pyloric/Colonic Dilation Balloons	50
CRE™ Wireguided Esophageal/Pyloric/Colonic/Biliary Dilation Balloons (including DASE indication)	46
Dreamtome™ RX Cannulating Sphincterotomes with Pre-loaded Dreamwire™ Guidewire	3
Dreamwire™ High Performance Guidewires	52
Dynamic™ (Y) Stents	74
Electrosurgical Bipolar Cable Adaptors	59
Encore™ 26 Inflation Device	8, 16
eXcelon™ Transbronchial Aspiration Needle with Syringe	77
Expect™ Slimline Handle Needles	21
Expect™ Standard Handle Needles	21
Extractor™ Pro DL Double-lumen Retrieval Balloons	15
Extractor™ Pro RX Triple-lumen Retrieval Balloons – Distal Injection	6
Extractor™ Pro RX Triple-lumen Retrieval Balloons – Proximal Injection	6
Extractor™ Pro XL Triple-lumen Retrieval Balloons – Distal Injection	15
Extractor™ Pro XL Triple-lumen Retrieval Balloons – Proximal Injection	15
Flexima™ Biliary Stents	31
Flexima™ Nasobiliary Stents	31
Fluoro Tip™ ERCP Cannulas	11
Gold Probe™ Electrohemostasis Catheters	57
Hurricane™ RX Biliary Dilation Balloons	7
Hydra Jagwire™ High Performance Guidewires	52
Hydratome™ RX Cannulating Sphincterotomes with Pre-loaded Hydra Jagwire™ Guidewire	3
Inflation/Deflation Devices and Accessories	49
Injection Gold Probe™ Electrohemostasis/Injection Catheters	57
Interject™ Clear Sclerotherapy Needles	58
Interject™ Sclerotherapy Needles	58
Jagtome™ RX Cannulating Sphincterotomes with Pre-loaded Jagwire™ Guidewire	4



Alphabetical Index (CONTINUED)

Jagwire™ High Performance Guidewires	53
Jagwire™ High Performance Guidewires – Extendable Jagwire	53
Jagwire™ Pulmonary Guidewire	78
Low Profile Button Replacements	71
Max Force™ Biliary Dilation Balloons	16
Max Force™ TTS Esophageal Dilation Balloons	48
Microknife™ XL Triple-lumen Needleknife	14
Multibite™ Multiple Sample Biopsy Forceps	67
NaviFlex™ RX Delivery System	29
NaviFlex™ RX Pancreatic Delivery System & NaviFlex Pushers	38
NaviPro™ 100% Hydrophilic Guidewires	54
One Step Button and Low Profile Button Accessories	70
One Step Button Low Profile PEG Kits	69
Optiflo™ Hemostasis Catheters	59
Pathfinder™ Exchange Guidewire	54
PEG/Replacement PEG Accessories	69
Percuflex™ Amsterdam Biliary Stents	32
Percuflex™ Amsterdam Introducer Kits	32
Polyflex Stent™ Self-expanding Silicone Airway Stents	76
Polyflex Stent™ Self-expanding Silicone Esophageal Stents	41
Profile™ Pediatric Snares	63
Radial Jaw™ 4 Gastropediatric Biopsy Forceps	67
Radial Jaw™ 4 Hot Biopsy Forceps	64
Radial Jaw™ 4 Jumbo Biopsy Forceps	67
Radial Jaw™ 4 Large Capacity Biopsy Forceps	66
Radial Jaw™ 4 Pulmonary Biopsy Forceps	77
Radial Jaw™ 4 Standard Capacity Biopsy Forceps	66
Recommended Anchoring Device	70
Resolution™ Clip	56
Rigiflex™ II Achalasia Dilation Balloons	48
Rotatable Snares	61
RX Accessories	8
RX Biliary Plastic Stents	30
RX Cannulas	2
RX Cytology Brush	7
RX Triple-lumen Needleknife	5
Sensation™ Short Throw Snares	61
Speedband Superview Super 7™ Multiple Band Ligators	56
SpyGlass™ Capital Equipment	19
SpyGlass™ Disposable Equipment	19
SpyGlass™ DS Capital Equipment	18
SpyGlass™ DS Disposable Equipment	18
SpyGlass™ Optional Accessories	19
SpyGlass™ Reusable Equipment	19
Standard Balloon Replacements	71
Standard PEGs	69
Stonetome™ Stone Removal Device	11
Tandem™ RX Cannula	2
Tandem™ XL Triple-lumen ERCP Cannula	10
Through-The-PEG (TTP) Jejunal Feeding Tube	70



Alphabetical Index (CONTINUED)

Trapezoid™ RX Wire-guided Retrieval Baskets	6
TRUEtome™ Cannulating Sphincterotomes	13
TRUEtome™ Dreamwire Cannulating Sphincterotomes with Pre-loaded Dreamwire™ Guidewire	12
TRUEtome™ Hydra Cannulating Sphincterotomes with Pre-loaded Hydra Jagwire™ Guidewire	12
TRUEtome™ Jag Cannulating Sphincterotomes with Pre-loaded Jagwire™ Guidewire	12
TWISTER® PLUS Rotatable Retrieval Device	64
Ultraflex Precision™ Colonic Stents	43
Ultraflex™ Covered Esophageal NG Stents – Distal Release	40
Ultraflex™ Covered Esophageal NG Stents – Proximal Release	40
Ultraflex™ Covered Tracheobronchial NG Stents – Distal Release – Bronchial Stents	74
Ultraflex™ Covered Tracheobronchial NG Stents – Distal Release – Tracheal Stents	74
Ultraflex™ Non-covered Esophageal NG Stents – Distal Release	40
Ultraflex™ Non-covered Esophageal NG Stents – Proximal Release	40
Ultraflex™ Non-covered Tracheobronchial NG Stents – Distal Release – Bronchial Stents	75
Ultraflex™ Non-covered Tracheobronchial NG Stents – Distal Release – Tracheal Stents	75
Ultraflex™ Non-covered Tracheobronchial NG Stents – Proximal Release – Bronchial Stents	75
Ultraflex™ Non-covered Tracheobronchial NG Stents – Proximal Release – Tracheal Stents	75
Ultratome XL™ Triple-lumen Wire-guided Sphincterotomes	14
Ultratome™ Double-lumen Wire-guided Sphincterotomes	14
WallFlex™ Biliary RX Fully Covered Stents with Permalume™ Covering	44
WallFlex™ Biliary RX Fully Covered Stents with Permalume™ Covering (including benign indication)	23
WallFlex™ Biliary RX Non-covered Stents	24
WallFlex™ Biliary RX Partially Covered Stents with Permalume™ Covering	23
WallFlex™ Colonic Stents	42
WallFlex™ Duodenal Stents	42
WallFlex™ Fully Covered Esophageal Stents with Permalume™ Covering	44
WallFlex™ Fully Covered Esophageal Stents with Permalume™ Covering (including benign indication)	39
WallFlex™ Partially Covered Esophageal Stents with Permalume™ Covering	39
Wallstent™ Biliary Stents	26
Wallstent™ Biliary Stents with Permalume™ Covering	26
Wallstent™ Colonic and Duodenal Stents	43
Wallstent™ RX Biliary Stents	25
Wallstent™ RX Biliary Stents with Permalume™ Covering	25
Wallstent™ Super Stiff Guidewire	54
ZeroTip™ Airway Retrieval Baskets	78



Product Code Index

Order Number	Description	Page Number
Wallstent™ Super Stiff Guidewire		
H965180011	Wallstent Super Stiff Guidewire	54
Wallstent™ Biliary Stents		
H965430100	Wallstent Biliary	26
H965430200	Wallstent Biliary	26
H965430300	Wallstent Biliary	26
H965430400	Wallstent Biliary	26
H965430500	Wallstent Biliary	26
H965430600	Wallstent Biliary	26
Wallstent™ Biliary Stents with Permalume™ Covering		
H965430700	Wallstent Biliary with Permalume	26
H965430800	Wallstent Biliary with Permalume	26
H965430900	Wallstent Biliary with Permalume	26
H965431000	Wallstent Biliary with Permalume	26
H965431100	Wallstent Biliary with Permalume	26
H965431200	Wallstent Biliary with Permalume	26
Alair™ Bronchial Thermoplasty (BT) System		
M005ATS20000	Alair RF Controller – monopolar (return electrode not included)	73
Alair™ BT Controller Accessory Kits ATS 201		
M005ATS20110	North American Plug	73
M005ATS20120	British Type G	73
M005ATS20130	EU Hybrid Type E/F	73
M005ATS20140	Australian Type I	73
M005ATS20150	Danish Type K	73
M005ATS20160	Brazil IEC 60906-1	73
M005ATS20170	Chinese CPCS-CCC (Chinese 10 A/250 V)	73
M005ATS20180	Swiss Type J	73
M005ATS20190	Israel Type H	73
Alair™ Bronchial Thermoplasty (BT) System		
M005ATS25010	Alair BT Catheter – North America	73
M005ATS25020	Alair BT Catheter – Global	73
Multibite™ Multiple Sample Biopsy Forceps		
M00510101	Multibite Multiple Sample Biopsy Forceps	67
M00510121	Multibite Multiple Sample Biopsy Forceps	67
Trapezoid™ RX Wire-guided Retrieval Baskets		
M00510860	Trapezoid RX Wire-guided Retrieval Basket	6
M00510870	Trapezoid RX Wire-guided Retrieval Basket	6
M00510880	Trapezoid RX Wire-guided Retrieval Basket	6
M00510890	Trapezoid RX Wire-guided Retrieval Basket	6
Optiflo™ Hemostasis Catheters		
M00511731	Optiflo Hemostasis Catheter	59
M00511751	Optiflo Hemostasis Catheter	59
ZeroTip™ Airway Retrieval Baskets		
M00513200	ZeroTip Airway Retrieval Basket	78

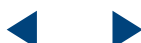

Product Code Index (CONTINUED)

Order Number	Description	Page Number
	ZeroTip™ Airway Retrieval Baskets (CONTINUED)	
M00513210	ZeroTip Airway Retrieval Basket	78
	Radial Jaw™ 4 Large Capacity Biopsy Forceps	
M00513301	Radial Jaw 4 Large Capacity	66
M00513302	Radial Jaw 4 Large Capacity	66
M00513303	Radial Jaw 4 Large Capacity	66
M00513311	Radial Jaw 4 Large Capacity w/Needle	66
M00513312	Radial Jaw 4 Large Capacity w/Needle	66
M00513313	Radial Jaw 4 Large Capacity w/Needle	66
M00513321	Radial Jaw 4 Large Capacity	66
M00513322	Radial Jaw 4 Large Capacity	66
M00513323	Radial Jaw 4 Large Capacity	66
M00513331	Radial Jaw 4 Large Capacity w/Needle	66
M00513332	Radial Jaw 4 Large Capacity w/Needle	66
M00513333	Radial Jaw 4 Large Capacity w/Needle	66
	Radial Jaw™ 4 Jumbo Biopsy Forceps	
M00513343	Radial Jaw 4 Jumbo	67
M00513353	Radial Jaw 4 Jumbo w/Needle	67
M00513361	Radial Jaw 4 Jumbo	67
M00513362	Radial Jaw 4 Jumbo	67
M00513363	Radial Jaw 4 Jumbo	67
M00513371	Radial Jaw 4 Jumbo w/Needle	67
M00513372	Radial Jaw 4 Jumbo w/Needle	67
M00513373	Radial Jaw 4 Jumbo w/Needle	67
	Radial Jaw™ 4 Standard Capacity Biopsy Forceps	
M00513381	Radial Jaw 4 Standard Capacity	66
M00513382	Radial Jaw 4 Standard Capacity	66
M00513383	Radial Jaw 4 Standard Capacity	66
M00513391	Radial Jaw 4 Standard Capacity w/Needle	66
M00513392	Radial Jaw 4 Standard Capacity w/Needle	66
M00513393	Radial Jaw 4 Standard Capacity w/Needle	66
M00513401	Radial Jaw 4 Standard Capacity	66
M00513402	Radial Jaw 4 Standard Capacity	66
M00513403	Radial Jaw 4 Standard Capacity	66
M00513411	Radial Jaw 4 Standard Capacity w/Needle	66
M00513412	Radial Jaw 4 Standard Capacity w/Needle	66
M00513413	Radial Jaw 4 Standard Capacity w/Needle	66
	Radial Jaw™ 4 Gastropediatric Biopsy Forceps	
M00513441	Radial Jaw 4 Gastropediatric	67
M00513443	Radial Jaw 4 Gastropediatric	67
M00513451	Radial Jaw 4 Gastropediatric w/Needle	67
M00513453	Radial Jaw 4 Gastropediatric w/Needle	67
	Ultraflex™ Non-covered Esophageal NG Stents – Distal Release	
M00513700	Ultraflex Esophageal NG Stent	40



Product Code Index (CONTINUED)

Order Number	Description	Page Number
Ultraflex™ Non-covered Esophageal NG Stents – Distal Release <small>(CONTINUED)</small>		
M00513710	Ultraflex Esophageal NG Stent	40
M00513720	Ultraflex Esophageal NG Stent	40
Ultraflex™ Covered Esophageal NG Stents – Distal Release		
M00513730	Ultraflex Esophageal NG Stent	40
M00513740	Ultraflex Esophageal NG Stent	40
M00513750	Ultraflex Esophageal NG Stent	40
Ultraflex™ Non-covered Esophageal NG Stents – Proximal Release		
M00513800	Ultraflex Esophageal NG Stent	40
M00513810	Ultraflex Esophageal NG Stent	40
M00513820	Ultraflex Esophageal NG Stent	40
M00513830	Ultraflex Esophageal NG Stent	40
Ultraflex™ Covered Esophageal NG Stents – Proximal Release		
M00513840	Ultraflex Esophageal NG Stent	40
M00513850	Ultraflex Esophageal NG Stent	40
M00513860	Ultraflex Esophageal NG Stent	40
Ultraflex™ Covered Esophageal NG Stents – Distal Release		
M00514200	Ultraflex Esophageal NG Stent	40
M00514210	Ultraflex Esophageal NG Stent	40
Ultraflex™ Non-covered Esophageal NG Stents – Proximal Release		
M00514220	Ultraflex Esophageal NG Stent	40
M00514230	Ultraflex Esophageal NG Stent	40
Ultraflex™ Covered Esophageal NG Stents – Proximal Release		
M00514240	Ultraflex Esophageal NG Stent	40
M00514250	Ultraflex Esophageal NG Stent	40
Polyflex Stent™ Self-expanding Silicone Esophageal Stents		
M00514270	Polyflex Esophageal Stent	41
M00514280	Polyflex Esophageal Stent	41
M00514290	Polyflex Esophageal Stent	41
M00514300	Polyflex Esophageal Stent	41
M00514310	Polyflex Esophageal Stent	41
M00514320	Polyflex Esophageal Stent	41
M00514330	Polyflex Esophageal Stent	41
M00514340	Polyflex Esophageal Stent	41
M00514350	Polyflex Esophageal Stent	41
Radial Jaw™ 4 Hot Biopsy Forceps		
M00515031	Radial Jaw 4 Hot Biopsy Forceps	64
M00515032	Radial Jaw 4 Hot Biopsy Forceps	64
M00515033	Radial Jaw 4 Hot Biopsy Forceps	64
Jagwire™ Pulmonary Guidewire		
M00515171	Jagwire	78
Radial Jaw™ 4 Pulmonary Biopsy Forceps		
M00515181	Radial Jaw 4 Standard Capacity	77
M00515182	Radial Jaw 4 Standard Capacity	77



Product Code Index (CONTINUED)

Order Number	Description	Page Number
Radial Jaw™ 4 Pulmonary Biopsy Forceps (CONTINUED)		
M00515191	Radial Jaw 4 Standard Capacity w/Needle	77
M00515192	Radial Jaw 4 Standard Capacity w/Needle	77
M00515201	Radial Jaw 4 Large Capacity	77
M00515202	Radial Jaw 4 Large Capacity	77
Cellebrity™ Endoscopic Cytology Brushes – Bronchoscope		
M00516001	Cellebrity Cytology Brush	77
M00516011	Cellebrity Cytology Brush	77
M00516071	Cellebrity Cytology Brush	77
M00516151	Cellebrity Cytology Brush	77
WallFlex™ Fully Covered Esophageal Stents with Permalume™ Covering (including benign indication)		
M00516210	WallFlex Fully Covered Esophageal Stent	39
M00516220	WallFlex Fully Covered Esophageal Stent	39
M00516230	WallFlex Fully Covered Esophageal Stent	39
M00516240	WallFlex Fully Covered Esophageal Stent	39
M00516250	WallFlex Fully Covered Esophageal Stent	39
M00516260	WallFlex Fully Covered Esophageal Stent	39
WallFlex™ Fully Covered Esophageal Stents with Permalume™ Covering		
M00516700	WallFlex Fully Covered Esophageal Stent	44
M00516710	WallFlex Fully Covered Esophageal Stent	44
M00516720	WallFlex Fully Covered Esophageal Stent	44
M00516730	WallFlex Fully Covered Esophageal Stent	44
M00516740	WallFlex Fully Covered Esophageal Stent	44
M00516750	WallFlex Fully Covered Esophageal Stent	44
WallFlex™ Partially Covered Esophageal Stents with Permalume™ Covering		
M00516900	WallFlex Partially Covered Esophageal Stent	39
M00516910	WallFlex Partially Covered Esophageal Stent	39
M00516920	WallFlex Partially Covered Esophageal Stent	39
M00516930	WallFlex Partially Covered Esophageal Stent	39
M00516940	WallFlex Partially Covered Esophageal Stent	39
M00516950	WallFlex Partially Covered Esophageal Stent	39
Interject™ Clear Sclerotherapy Needles		
M00518111	Interject Sclerotherapy Needle	58
Interject™ Sclerotherapy Needles		
M00518151	Interject Sclerotherapy Needle	58
M00518161	Interject Sclerotherapy Needle	58
M00518251	Interject Sclerotherapy Needle	58
M00518261	Interject Sclerotherapy Needle	58
Interject™ Clear Sclerotherapy Needles		
M00518301	Interject Sclerotherapy Needle	58
M00518311	Interject Sclerotherapy Needle	58
Interject™ Sclerotherapy Needles		
M00518351	Interject Sclerotherapy Needle	58
M00518361	Interject Sclerotherapy Needle	58



Product Code Index (CONTINUED)

Order Number	Description	Page Number
Resolution™ Clip		
M00522600	Resolution Clip	56
M00522601	Resolution Clip	56
M00522602	Resolution Clip	56
M00522610	Resolution Clip	56, 70
M00522611	Resolution Clip	56, 70
M00522612	Resolution Clip	56, 70
Ultratome™ Double-lumen Wire-guided Sphincterotomes		
M00530800	Ultratome Short Nose	14
M00530810	Ultratome Long Nose	14
M00530820	Ultratome Short Nose	14
M00530830	Ultratome Long Nose	14
Contour™ ERCP Cannulas		
M00530850	Contour ERCP Cannula	10
M00530860	Contour ERCP Cannula	10
M00530870	Contour ERCP Cannula	10
M00530880	Contour ERCP Cannula	10
M00530890	Contour ERCP Cannula	10
Fluoro Tip™ ERCP Cannulas		
M00530960	Fluoro Tip ERCP Cannula, Standard Tip	11
M00530970	Fluoro Tip ERCP Cannula, Tapered Tip	11
M00530980	Fluoro Tip ERCP Cannula, Ultra Tapered Tip	11
C-flex™ Pigtail Biliary Stents		
M00532010	C-flex Pigtail Stent	32
M00532020	C-flex Pigtail Stent	32
M00532030	C-flex Pigtail Stent	32
M00532040	C-flex Pigtail Stent	32
M00532050	C-flex Pigtail Stent	32
M00532060	C-flex Pigtail Stent	32
Advanix™ Stents – Singles		
M00532160	Advanix Stent	29
M00532180	Advanix Stent	29
M00532190	Advanix Stent	29
M00532210	Advanix Stent	29
M00532220	Advanix Stent	29
M00532230	Advanix Stent	29
M00532240	Advanix Stent	29
M00532260	Advanix Stent	29
M00532270	Advanix Stent	29
M00532290	Advanix Stent	29
M00532300	Advanix Stent	29
M00532310	Advanix Stent	29
Microknife™ XL Triple-lumen Needleknife		
M00532810	Microknife XL Triple-lumen Needleknife	14



Product Code Index (CONTINUED)

Order Number	Description	Page Number
Advanix™ Stents – Singles		
M00532870	Advanix Stent	28
M00532880	Advanix Stent	28
M00532890	Advanix Stent	28
M00532900	Advanix Stent	28
M00532910	Advanix Stent	28
M00532920	Advanix Stent	28
M00532930	Advanix Stent	28
M00532940	Advanix Stent	28
M00532950	Advanix Stent	28
M00532960	Advanix Stent	28
M00532970	Advanix Stent	28
M00532980	Advanix Stent	28
M00532990	Advanix Stent	28
M00533000	Advanix Stent	28
M00533010	Advanix Stent	28
M00533020	Advanix Stent	28
M00533030	Advanix Stent	28
M00533040	Advanix Stent	28
M00533230	Advanix Stent	28
M00533240	Advanix Stent	28
M00533250	Advanix Stent	28
M00533260	Advanix Stent	28
M00533270	Advanix Stent	28
M00533280	Advanix Stent	28
M00533290	Advanix Stent	28
M00533300	Advanix Stent	28
M00533310	Advanix Stent	28
M00533320	Advanix Stent	28
M00533330	Advanix Stent	28
M00533340	Advanix Stent	28
M00533350	Advanix Stent	28
M00533360	Advanix Stent	28
M00533370	Advanix Stent	28
M00533380	Advanix Stent	28
M00533390	Advanix Stent	28
M00533400	Advanix Stent	28
NaviFlex™ RX Delivery System		
M00533560	RX Delivery System	29
M00533570	RX Delivery System	29
M00533580	RX Delivery System	29
Percuflex™ Amsterdam Biliary Stents		
M00533610	Percuflex Amsterdam Stent	32
M00533620	Percuflex Amsterdam Stent	32



Product Code Index (CONTINUED)

Order Number	Description	Page Number
Percuflex™ Amsterdam Biliary Stents (CONTINUED)		
M00533630	Percuflex Amsterdam Stent	32
M00533640	Percuflex Amsterdam Stent	32
M00533650	Percuflex Amsterdam Stent	32
M00533660	Percuflex Amsterdam Stent	32
M00533670	Percuflex Amsterdam Stent	32
M00533680	Percuflex Amsterdam Stent	32
M00533690	Percuflex Amsterdam Stent	32
M00533700	Percuflex Amsterdam Stent	32
Percuflex™ Amsterdam Introducer Kits		
M00533910	Percuflex Amsterdam Stent Kit w/push catheter for use with 7F (2.33mm) O.D. stent	32
M00533920	Percuflex Amsterdam Stent Kit w/push and guide catheter for use with 10F (3.33mm) O.D. stent	32
Advanix™ Pre-loaded RX Stents with NaviFlex™ RX Delivery System		
M00534200	Advanix Pre-loaded RX Stent	27
M00534210	Advanix Pre-loaded RX Stent	27
M00534220	Advanix Pre-loaded RX Stent	27
M00534230	Advanix Pre-loaded RX Stent	27
M00534240	Advanix Pre-loaded RX Stent	27
M00534250	Advanix Pre-loaded RX Stent	27
M00534260	Advanix Pre-loaded RX Stent	27
M00534270	Advanix Pre-loaded RX Stent	27
M00534280	Advanix Pre-loaded RX Stent	27
M00534290	Advanix Pre-loaded RX Stent	27
M00534300	Advanix Pre-loaded RX Stent	27
M00534310	Advanix Pre-loaded RX Stent	27
M00534320	Advanix Pre-loaded RX Stent	27
M00534330	Advanix Pre-loaded RX Stent	27
M00534340	Advanix Pre-loaded RX Stent	27
M00534350	Advanix Pre-loaded RX Stent	27
M00534360	Advanix Pre-loaded RX Stent	27
M00534370	Advanix Pre-loaded RX Stent	27
M00534560	Advanix Pre-loaded RX Stent	27
M00534570	Advanix Pre-loaded RX Stent	27
M00534580	Advanix Pre-loaded RX Stent	27
M00534590	Advanix Pre-loaded RX Stent	27
M00534600	Advanix Pre-loaded RX Stent	27
M00534610	Advanix Pre-loaded RX Stent	27
M00534620	Advanix Pre-loaded RX Stent	27
M00534630	Advanix Pre-loaded RX Stent	27
M00534640	Advanix Pre-loaded RX Stent	27
M00534650	Advanix Pre-loaded RX Stent	27
M00534660	Advanix Pre-loaded RX Stent	27
M00534670	Advanix Pre-loaded RX Stent	27
M00534680	Advanix Pre-loaded RX Stent	27



Product Code Index (CONTINUED)

Order Number	Description	Page Number
Advanix™ Pre-loaded RX Stents with NaviFlex™ RX Delivery System (CONTINUED)		
M00534690	Advanix Pre-loaded RX Stent	27
M00534700	Advanix Pre-loaded RX Stent	27
M00534710	Advanix Pre-loaded RX Stent	27
M00534720	Advanix Pre-loaded RX Stent	27
M00534730	Advanix Pre-loaded RX Stent	27
NaviFlex™ RX Pancreatic Delivery System & NaviFlex Pushers		
M00535000	Pancreatic Stent RX Pusher	38
M00535010	Pancreatic Stent RX Pusher	38
M00535020	Pancreatic Stent Pusher	38
M00535030	Pancreatic Stent Pusher	38
M00535060	NaviFlex RX Pancreatic Stent Delivery System	38
M00535080	NaviFlex RX Pancreatic Stent Delivery System	38
Stonetome™ Stone Removal Device		
M00535110	Stonetome (above cut wire)	11
M00535130	Stonetome (above cut wire)	11
M00535150	Stonetome (below cut wire)	11
M00535170	Stonetome (below cut wire)	11
M00535190	Stonetome (below cut wire)	11
M00535210	Stonetome (below cut wire)	11
Tandem™ XL Triple-lumen ERCP Cannula		
M00535700	Tandem XL Triple-lumen ERCP Cannula	10
Ultratome XL™ Triple-lumen Wire-guided Sphincterotomes		
M00535900	Ultratome XL Short Nose	14
M00535910	Ultratome XL Long Nose	14
M00535920	Ultratome XL Short Nose	14
M00535930	Ultratome XL Long Nose	14
Advanix™ Pancreatic Single Stents – Straight		
M00536000	Advanix Pancreatic Stent	35
M00536010	Advanix Pancreatic Stent	35
M00536020	Advanix Pancreatic Stent	35
M00536030	Advanix Pancreatic Stent	35
M00536040	Advanix Pancreatic Stent	35
M00536050	Advanix Pancreatic Stent	35
M00536060	Advanix Pancreatic Stent	35
M00536070	Advanix Pancreatic Stent	35
M00536080	Advanix Pancreatic Stent	36
M00536090	Advanix Pancreatic Stent	36
M00536100	Advanix Pancreatic Stent	36
M00536110	Advanix Pancreatic Stent	36
M00536120	Advanix Pancreatic Stent	36
M00536130	Advanix Pancreatic Stent	36
M00536140	Advanix Pancreatic Stent	36
M00536150	Advanix Pancreatic Stent	36



Product Code Index (CONTINUED)

Order Number	Description	Page Number
	Advanix™ Pancreatic Single Stents – Straight (CONTINUED)	
M00536160	Advanix Pancreatic Stent	36
M00536170	Advanix Pancreatic Stent	36
M00536180	Advanix Pancreatic Stent	36
M00536190	Advanix Pancreatic Stent	36
M00536200	Advanix Pancreatic Stent	36
M00536210	Advanix Pancreatic Stent	36
M00536220	Advanix Pancreatic Stent	36
M00536230	Advanix Pancreatic Stent	36
M00536240	Advanix Pancreatic Stent	36
M00536250	Advanix Pancreatic Stent	36
M00536260	Advanix Pancreatic Stent	36
M00536270	Advanix Pancreatic Stent	36
M00536280	Advanix Pancreatic Stent	36
M00536290	Advanix Pancreatic Stent	36
M00536300	Advanix Pancreatic Stent	36
M00536310	Advanix Pancreatic Stent	36
M00536320	Advanix Pancreatic Stent	36
M00536330	Advanix Pancreatic Stent	36
M00536340	Advanix Pancreatic Stent	36
M00536350	Advanix Pancreatic Stent	36
M00536360	Advanix Pancreatic Stent	36
M00536370	Advanix Pancreatic Stent	36
M00536380	Advanix Pancreatic Stent	36
M00536390	Advanix Pancreatic Stent	36
M00536400	Advanix Pancreatic Stent	36
M00536410	Advanix Pancreatic Stent	36
M00536420	Advanix Pancreatic Stent	36
M00536430	Advanix Pancreatic Stent	36
M00536440	Advanix Pancreatic Stent	36
M00536450	Advanix Pancreatic Stent	37
M00536460	Advanix Pancreatic Stent	37
M00536470	Advanix Pancreatic Stent	37
M00536480	Advanix Pancreatic Stent	37
M00536490	Advanix Pancreatic Stent	37
M00536500	Advanix Pancreatic Stent	37
M00536510	Advanix Pancreatic Stent	37
M00536520	Advanix Pancreatic Stent	37
M00536530	Advanix Pancreatic Stent	37
M00536540	Advanix Pancreatic Stent	37
M00536550	Advanix Pancreatic Stent	37
M00536560	Advanix Pancreatic Stent	37
M00536570	Advanix Pancreatic Stent	37
M00536580	Advanix Pancreatic Stent	37



Product Code Index (CONTINUED)

Order Number	Description	Page Number
Advanix™ Pancreatic Single Stents – Straight (CONTINUED)		
M00536590	Advanix Pancreatic Stent	37
M00536600	Advanix Pancreatic Stent	37
M00536610	Advanix Pancreatic Stent	37
M00536620	Advanix Pancreatic Stent	37
M00536630	Advanix Pancreatic Stent	37
M00536640	Advanix Pancreatic Stent	37
M00536650	Advanix Pancreatic Stent	37
M00536660	Advanix Pancreatic Stent	37
M00536670	Advanix Pancreatic Stent	37
M00536680	Advanix Pancreatic Stent	37
M00536690	Advanix Pancreatic Stent	37
M00536700	Advanix Pancreatic Stent	37
M00536710	Advanix Pancreatic Stent	37
M00536720	Advanix Pancreatic Stent	37
M00536730	Advanix Pancreatic Stent	37
Advanix™ Pancreatic Single Stents – Pigtail		
M00536740	Advanix Pancreatic Stent	34
M00536750	Advanix Pancreatic Stent	34
M00536760	Advanix Pancreatic Stent	34
M00536770	Advanix Pancreatic Stent	34
M00536780	Advanix Pancreatic Stent	34
M00536790	Advanix Pancreatic Stent	34
M00536800	Advanix Pancreatic Stent	34
M00536810	Advanix Pancreatic Stent	34
M00536820	Advanix Pancreatic Stent	34
M00536830	Advanix Pancreatic Stent	34
M00536840	Advanix Pancreatic Stent	34
M00536850	Advanix Pancreatic Stent	34
M00536860	Advanix Pancreatic Stent	34
M00536870	Advanix Pancreatic Stent	34
M00536880	Advanix Pancreatic Stent	34
M00536890	Advanix Pancreatic Stent	34
M00536900	Advanix Pancreatic Stent	34
M00536910	Advanix Pancreatic Stent	34
M00536920	Advanix Pancreatic Stent	34
M00536930	Advanix Pancreatic Stent	34
M00536940	Advanix Pancreatic Stent	34
M00536950	Advanix Pancreatic Stent	34
M00536960	Advanix Pancreatic Stent	34
M00536970	Advanix Pancreatic Stent	34
M00536980	Advanix Pancreatic Stent	34
M00536990	Advanix Pancreatic Stent	34
M00537000	Advanix Pancreatic Stent	34



Product Code Index (CONTINUED)

Order Number	Description	Page Number
Advanix™ Pancreatic Single Stents – Pigtail <small>(CONTINUED)</small>		
M00537010	Advanix Pancreatic Stent	34
M00537020	Advanix Pancreatic Stent	34
M00537030	Advanix Pancreatic Stent	34
M00537040	Advanix Pancreatic Stent	34
M00537050	Advanix Pancreatic Stent	34
M00537060	Advanix Pancreatic Stent	34
M00537070	Advanix Pancreatic Stent	34
M00537080	Advanix Pancreatic Stent	34
M00537090	Advanix Pancreatic Stent	34
M00537100	Advanix Pancreatic Stent	35
M00537110	Advanix Pancreatic Stent	35
M00537120	Advanix Pancreatic Stent	35
M00537130	Advanix Pancreatic Stent	35
M00537140	Advanix Pancreatic Stent	35
M00537150	Advanix Pancreatic Stent	35
M00537160	Advanix Pancreatic Stent	35
M00537170	Advanix Pancreatic Stent	35
M00537180	Advanix Pancreatic Stent	35
M00537190	Advanix Pancreatic Stent	35
M00537200	Advanix Pancreatic Stent	35
M00537210	Advanix Pancreatic Stent	35
M00537220	Advanix Pancreatic Stent	35
M00537230	Advanix Pancreatic Stent	35
M00537240	Advanix Pancreatic Stent	35
M00537250	Advanix Pancreatic Stent	35
M00537260	Advanix Pancreatic Stent	35
M00537270	Advanix Pancreatic Stent	35
M00537280	Advanix Pancreatic Stent	35
M00537290	Advanix Pancreatic Stent	35
M00537300	Advanix Pancreatic Stent	35
M00537310	Advanix Pancreatic Stent	35
M00537320	Advanix Pancreatic Stent	35
M00537330	Advanix Pancreatic Stent	35
M00537340	Advanix Pancreatic Stent	35
Advanix™ Pancreatic Stent Kits (Stent+ RX Pusher) – Pigtail		
M00537350	Advanix Pancreatic Stent Kit	33
M00537360	Advanix Pancreatic Stent Kit	33
M00537370	Advanix Pancreatic Stent Kit	33
M00537380	Advanix Pancreatic Stent Kit	33
M00537390	Advanix Pancreatic Stent Kit	33
M00537400	Advanix Pancreatic Stent Kit	33
M00537410	Advanix Pancreatic Stent Kit	33
M00537420	Advanix Pancreatic Stent Kit	33



Product Code Index (CONTINUED)

Order Number	Description	Page Number
Advanix™ Pancreatic Stent Kits (Stent + RX Pusher) – Pigtail <small>(CONTINUED)</small>		
M00537430	Advanix Pancreatic Stent Kit	33
M00537440	Advanix Pancreatic Stent Kit	33
M00537450	Advanix Pancreatic Stent Kit	33
Advanix™ Pancreatic Stent Kits (Stent + RX Pusher) – Straight		
M00537460	Advanix Pancreatic Stent Kit	33
M00537470	Advanix Pancreatic Stent Kit	33
M00537480	Advanix Pancreatic Stent Kit	33
M00537490	Advanix Pancreatic Stent Kit	33
M00537500	Advanix Pancreatic Stent Kit	33
M00537510	Advanix Pancreatic Stent Kit	33
M00537520	Advanix Pancreatic Stent Kit	33
M00537530	Advanix Pancreatic Stent Kit	33
M00537540	Advanix Pancreatic Stent Kit	33
M00537550	Advanix Pancreatic Stent Kit	33
M00537560	Advanix Pancreatic Stent Kit	33
Flexima™ Biliary Stents		
M00539200	Flexima Stent	31
M00539210	Flexima Stent	31
M00539220	Flexima Stent	31
M00539230	Flexima Stent	31
M00539240	Flexima Stent	31
M00539250	Flexima Stent	31
M00539260	Flexima Stent	31
M00539270	Flexima Stent	31
M00539280	Flexima Stent	31
M00539290	Flexima Stent	31
M00539300	Flexima Stent	31
M00539310	Flexima Stent	31
M00539320	Flexima Stent	31
M00539330	Flexima Stent	31
M00539340	Flexima Stent	31
M00539350	Flexima Stent	31
M00539360	Flexima Stent	31
M00539370	Flexima Stent	31
M00539380	Flexima Stent	31
M00539390	Flexima Stent	31
Flexima™ Nasobiliary Stents		
M00540120	Flexima Nasal Stent	31
M00540130	Flexima Nasal Stent	31
M00540140	Flexima Nasal Stent	31
M00540160	Flexima Nasal Stent	31
M00540170	Flexima Nasal Stent	31
M00540180	Flexima Nasal Stent	31



Product Code Index (CONTINUED)

Order Number	Description	Page Number
Speedband Superview Super 7™ Multiple Band Ligators		
M00542250	Super 7 Band Ligator	56
M00542251	Super 7 Band Ligator	56
M00542253	Super 7 Band Ligator	56
RX Cytology Brush		
M00545000	RX Cytology Brush	7
Autotome™ RX Cannulating Sphincterotomes		
M00545150	Autotome RX 49	5
M00545160	Autotome RX 49	5
M00545170	Autotome RX 44	5
M00545180	Autotome RX 44	5
M00545190	Autotome RX 39	5
M00545200	Autotome RX 39	5
RX Accessories		
M00545211	RX Locking Device – Olympus/Fujinon Brand Endoscope Compatible	8
M00545221	RX Locking Device – Pentax Brand Endoscope Compatible	8
M00545261	RX Locking Device and Biopsy Cap System – Olympus Compatible	8
M00545271	RX Locking Device and Biopsy Cap System – Pentax Compatible	8
M00545281	RX Locking Device and Biopsy Cap System – Fujinon Compatible	8
M00545471	RX Locking Device	8
RX Biliary Plastic Stents		
M00545550	RX Biliary Plastic Stent	30
M00545560	RX Biliary Plastic Stent	30
M00545570	RX Biliary Plastic Stent	30
M00545580	RX Biliary Plastic Stent	30
M00545590	RX Biliary Plastic Stent	30
M00545600	RX Biliary Plastic Stent	30
M00545610	RX Biliary Plastic Stent	30
M00545620	RX Biliary Plastic Stent	30
M00545630	RX Biliary Plastic Stent	30
M00545640	RX Biliary Plastic Stent	30
M00545650	RX Biliary Plastic Stent	30
M00545660	RX Biliary Plastic Stent	30
M00545670	RX Biliary Plastic Stent	30
M00545680	RX Biliary Plastic Stent	30
M00545690	RX Biliary Plastic Stent	30
M00545700	RX Biliary Plastic Stent	30
M00545710	RX Biliary Plastic Stent	30
M00545720	RX Biliary Plastic Stent	30
M00545730	RX Biliary Plastic Stent	30
M00545740	RX Biliary Plastic Stent	30
RX Cannulas		
M00545760	RX Standard ERCP Cannula	2
M00545770	RX Tapered ERCP Cannula	2



Product Code Index (CONTINUED)

Order Number	Description	Page Number
RX Cannulas <small>(CONTINUED)</small>		
M00545780	RX Ball Tip ERCP Cannula	2
Tandem™ RX Cannula		
M00545820	Tandem RX Cannula	2
RX Triple-lumen Needleknife		
M00545840	Needleknife RX	5
Hurricane™ RX Biliary Dilation Balloons		
M00545890	Hurricane RX Dilation Balloon	7
M00545900	Hurricane RX Dilation Balloon	7
M00545910	Hurricane RX Dilation Balloon	7
M00545920	Hurricane RX Dilation Balloon	7
M00545930	Hurricane RX Dilation Balloon	7
M00545940	Hurricane RX Dilation Balloon	7
M00545950	Hurricane RX Dilation Balloon	7
M00545960	Hurricane RX Dilation Balloon	7
SpyGlass™		
M00546030	SpyGlass Direct Visualisation Probe	19
M00546040	SpyGlass Ocular	19
M00546050	SpyGlass Storage Tray – Small	19
M00546060	SpyGlass Storage Tray – Large	19
M00546070	3-Joint Arm with Clamp	19
M00546110	SpyGlass Camera PAL	19
M00546120	SpyGlass Video Monitor	19
M00546140	Irrigation Pump with Foot Switch	19
M00546160	SpyGlass Travel Cart	19
M00546190	SpyGlass Lightsource	19
M00546200	SpyGlass Light Source Replacement Bulb	19
M00546210	SpyGlass Light Cable	19
M00546230	SpyScope™ Access and Delivery Catheter	19
M00546240	Isolation Transformer 230 V	19
M00546250	Power Cable Pack	19
M00546270	SpyBite™ Biopsy Forceps	19
SpyGlass™ DS		
M00546270	SpyBite™ Biopsy Forceps	18
M00546451	SpyGlass Irrigation Tube Set	18
SpyGlass™		
M00546451	SpyGlass Irrigation Tube Set	19
SpyGlass™ DS		
M00546600	SpyScope™ DS Access and Delivery Catheter	18
M00546650	SpyGlass DS Digital Controller	18
Extractor™ Pro RX Triple-lumen Retrieval Balloons – Distal Injection		
M00547000	Extractor Pro RX Triple-lumen Retrieval Balloon	6
M00547010	Extractor Pro RX Triple-lumen Retrieval Balloon	6
M00547020	Extractor Pro RX Triple-lumen Retrieval Balloon	6



Product Code Index (CONTINUED)

Order Number	Description	Page Number
Extractor™ Pro RX Triple-lumen Retrieval Balloons – Proximal Injection		
M00547030	Extractor Pro RX Triple-lumen Retrieval Balloon	6
M00547040	Extractor Pro RX Triple-lumen Retrieval Balloon	6
M00547050	Extractor Pro RX Triple-lumen Retrieval Balloon	6
Extractor™ Pro XL Triple-lumen Retrieval Balloons – Distal Injection		
M00547100	Extractor Pro XL Triple-lumen Retrieval Balloon	15
M00547110	Extractor Pro XL Triple-lumen Retrieval Balloon	15
M00547120	Extractor Pro XL Triple-lumen Retrieval Balloon	15
Extractor™ Pro XL Triple-lumen Retrieval Balloons – Proximal Injection		
M00547130	Extractor Pro RX Triple-lumen Retrieval Balloon	15
M00547140	Extractor Pro RX Triple-lumen Retrieval Balloon	15
M00547150	Extractor Pro RX Triple-lumen Retrieval Balloon	15
Extractor™ Pro DL Double-lumen Retrieval Balloons		
M00547200	Extractor Pro DL Double-lumen Retrieval Balloon	15
M00547210	Extractor Pro DL Double-lumen Retrieval Balloon	15
M00547220	Extractor Pro DL Double-lumen Retrieval Balloon	15
Expect™ Standard Handle Needle		
M00550000	Expect Standard Handle Needle	21
M00550001	Expect Standard Handle Needle	21
M00550010	Expect Standard Handle Needle	21
M00550011	Expect Standard Handle Needle	21
M00550020	Expect Standard Handle Needle	21
M00550021	Expect Standard Handle Needle	21
M00550040	Expect Standard Handle Needle	21
M00550041	Expect Standard Handle Needle	21
Amplatz™ Super Stiff Guidewire		
M00550090	Amplatz Super Stiff Guidewire	54
CRE™ Pulmonary Dilation Balloons		
M00550300	CRE Balloon	78
M00550310	CRE Balloon	78
M00550320	CRE Balloon	78
M00550330	CRE Balloon	78
M00550340	CRE Balloon	78
M00550350	CRE Balloon	78
Alliance™ II Inflation System		
M00550601	60ml Syringe/Gauge Assembly	49, 79
M00550620	Alliance™ II Inflation Handle	6, 49, 79
Pathfinder™ Exchange Guidewire		
M00551591	Pathfinder Exchange Guidewire Stiff Shaft	54
Inflation/Deflation Devices and Accessories		
M00553200	Achalasia Pneumatic Hand Pump and Monitor	49
Rigiflex™ II Achalasia Dilation Balloons		
M00554500	Rigiflex II Achalasia Dilation Balloon	48
M00554510	Rigiflex II Achalasia Dilation Balloon	48



Product Code Index (CONTINUED)

Order Number	Description	Page Number
Rigiflex™ II Achalasia Dilation Balloons (CONTINUED)		
M00554520	Rigiflex II Achalasia Dilation Balloon	48
Expect™ Slimline Handle Needle		
M00555500	Expect Slimline Handle Needle	21
M00555501	Expect Slimline Handle Needle	21
M00555510	Expect Slimline Handle Needle	21
M00555511	Expect Slimline Handle Needle	21
M00555520	Expect Slimline Handle Needle	21
M00555521	Expect Slimline Handle Needle	21
M00555530	Expect Slimline Handle Needle	21
M00555531	Expect Slimline Handle Needle	21
Hydra Jagwire™ High Performance Guidewires		
M00556001	Hydra Jagwire Standard	52
M00556011	Hydra Jagwire Standard	52
M00556021	Hydra Jagwire Stiff Shaft	52
M00556031	Hydra Jagwire Stiff Shaft	52
M00556041	Hydra Jagwire Standard	52
M00556051	Hydra Jagwire Standard	52
M00556061	Hydra Jagwire Stiff Shaft	52
M00556071	Hydra Jagwire Stiff Shaft	52
Dreamwire™ High Performance Guidewires		
M00556101	Dreamwire Standard	52
M00556111	Dreamwire Standard	52
M00556121	Dreamwire Stiff Shaft	52
M00556131	Dreamwire Stiff Shaft	52
M00556141	Dreamwire Standard	52
M00556151	Dreamwire Standard	52
M00556161	Dreamwire Stiff Shaft	52
M00556171	Dreamwire Stiff Shaft	52
NaviPro™ 100% Hydrophilic Guidewires		
M00556181	NaviPro Standard	54
M00556191	NaviPro Standard	54
M00556201	NaviPro Standard	54
M00556211	NaviPro Standard	54
M00556221	NaviPro Standard	54
M00556231	NaviPro Standard	54
M00556241	NaviPro Stiff Shaft	54
M00556251	NaviPro Stiff Shaft	54
Jagwire™ High Performance Guidewires		
M00556461	Jagwire Standard	53
M00556481	Jagwire Stiff Shaft	53
M00556491	Jagwire Stiff Shaft	53
M00556511	Jagwire Standard	53
M00556521	Jagwire Stiff Shaft	53



Product Code Index (CONTINUED)

Order Number	Description	Page Number
Jagwire™ High Performance Guidewires <small>(CONTINUED)</small>		
M00556531	Jagwire Stiff Shaft	53
M00556561	Jagwire Standard	53
M00556581	Jagwire Standard	53
M00556591	Jagwire Standard	53
M00556601	Jagwire Stiff Shaft	53
M00556611	Jagwire Stiff Shaft	53
M00556621	Jagwire Stiff Shaft	53
Jagwire™ High Performance Guidewires – Extendable Jagwire		
M00556902	Jagwire Jag Tail	53
M00556841	Jagwire Standard	53
M00556851	Jagwire Standard	53
M00556861	Jagwire Stiff Shaft	53
M00556871	Jagwire Stiff Shaft	53
Ultraflex Precision™ Colonic Stents		
M00557330	Ultraflex Precision Colonic Stent	43
M00557360	Ultraflex Precision Colonic Stent	43
M00557380	Ultraflex Precision Colonic Stent	43
Jagwire™ High Performance Guidewires		
M00557641	Jagwire Standard	53
M00557651	Jagwire Standard	53
M00557661	Jagwire Stiff Shaft	53
M00557671	Jagwire Stiff Shaft	53
CRE™ Fixed Wire Dilation Balloons		
M00558330	CRE Fixed Wire Dilation Balloon	47
M00558340	CRE Fixed Wire Dilation Balloon	47
M00558350	CRE Fixed Wire Dilation Balloon	47
M00558360	CRE Fixed Wire Dilation Balloon	47
M00558361	CRE Fixed Wire Dilation Balloon	47
M00558370	CRE Fixed Wire Dilation Balloon	47
M00558371	CRE Fixed Wire Dilation Balloon	47
M00558380	CRE Fixed Wire Dilation Balloon	47
M00558381	CRE Fixed Wire Dilation Balloon	47
CRE™ Wireguided Esophageal/Pyloric Dilation Balloons		
M00558390	CRE Wireguided Esophageal/Pyloric Dilation Balloon	50
M00558400	CRE Wireguided Esophageal/Pyloric Dilation Balloon	50
M00558410	CRE Wireguided Esophageal/Pyloric Dilation Balloon	50
M00558420	CRE Wireguided Esophageal/Pyloric Dilation Balloon	50
M00558430	CRE Wireguided Esophageal/Pyloric Dilation Balloon	50
M00558440	CRE Wireguided Esophageal/Pyloric Dilation Balloon	50
CRE™ Wireguided Esophageal/Pyloric/Colonic Dilation Balloons		
M00558450	CRE Wireguided Esophageal/Pyloric/Colonic Dilation Balloon	50
M00558460	CRE Wireguided Esophageal/Pyloric/Colonic Dilation Balloon	50
M00558470	CRE Wireguided Esophageal/Pyloric/Colonic Dilation Balloon	50



Product Code Index (CONTINUED)

Order Number	Description	Page Number
CRE™ Wireguided Esophageal/Pyloric/Colonic Dilation Balloons (CONTINUED)		
M00558480	CRE Wireguided Esophageal/Pyloric/Colonic Dilation Balloon	50
M00558490	CRE Wireguided Esophageal/Pyloric/Colonic Dilation Balloon	50
M00558500	CRE Wireguided Esophageal/Pyloric/Colonic Dilation Balloon	50
CRE™ Wireguided Esophageal/Pyloric/Biliary Dilation Balloons (including DASE indication)		
M00558600	CRE Wireguided Esophageal/Pyloric/Biliary Dilation Balloons (including DASE indication)	46
M00558610	CRE Wireguided Esophageal/Pyloric/Biliary Dilation Balloons (including DASE indication)	46
M00558620	CRE Wireguided Esophageal/Pyloric/Biliary Dilation Balloons (including DASE indication)	46
M00558630	CRE Wireguided Esophageal/Pyloric/Biliary Dilation Balloons (including DASE indication)	46
M00558640	CRE Wireguided Esophageal/Pyloric/Biliary Dilation Balloons (including DASE indication)	46
M00558650	CRE Wireguided Esophageal/Pyloric/Biliary Dilation Balloons (including DASE indication)	46
CRE™ Wireguided Esophageal/Pyloric/Colonic/Biliary Dilation Balloons (including DASE indication)		
M00558660	CRE Wireguided Esophageal/Pyloric/Colonic/Biliary Dilation Balloons (including DASE indication)	46
M00558670	CRE Wireguided Esophageal/Pyloric/Colonic/Biliary Dilation Balloons (including DASE indication)	46
M00558680	CRE Wireguided Esophageal/Pyloric/Colonic/Biliary Dilation Balloons (including DASE indication)	46
M00558690	CRE Wireguided Esophageal/Pyloric/Colonic/Biliary Dilation Balloons (including DASE indication)	46
M00558700	CRE Wireguided Esophageal/Pyloric/Colonic/Biliary Dilation Balloons (including DASE indication)	46
M00558710	CRE Wireguided Esophageal/Pyloric/Colonic/Biliary Dilation Balloons (including DASE indication)	46
Gold Probe™ Electrohemostasis Catheters		
M00560070	Gold Probe Catheter	57
M00560071	Gold Probe Catheter	57
M00560100	Gold Probe Catheter	57
M00560101	Gold Probe Catheter	57
Injection Gold Probe™ Electrohemostasis/Injection Catheters		
M00560150	Injection Gold Probe Catheter	57
M00560160	Injection Gold Probe Catheter	57
Gold Probe™ Electrohemostasis Catheters		
M00560220	Gold Probe Catheter	57
Sensation™ Short Throw Snares		
M00560311	Medium Oval	61
M00560321	Small Oval	61
M00560331	Medium Crescent	61
Captivator™ II Snares		
M00561191	25 mm Rounded	63
M00561192	25 mm Rounded	63
M00561193	25 mm Rounded	63
M00561221	10 mm Rounded	63
M00561222	10 mm Rounded	63
M00561223	10 mm Rounded	63
M00561231	15 mm Rounded	63
M00561232	15 mm Rounded	63
M00561233	15 mm Rounded	63
M00561241	20 mm Rounded	63
M00561242	20 mm Rounded	63



Product Code Index (CONTINUED)

Order Number	Description	Page Number
	Captivator™ II Snares <small>(CONTINUED)</small>	
M00561243	20mm Rounded	63
	Accessories	
M00561250	Active Cord, Fits Olympus Brand Generator	16, 64
M00561270	Active Cord, Fits Bovie®, Endostat™, Endostat II, Valleylab, Aspen Labs, ERBE Brand Generators	16, 64
	Captivator™ II Snares	
M00561291	33mm Rounded	63
	Captivator™ Snares	
M00561311	Large Oval	62
	TWISTER® PLUS Rotatable Retrieval Device	
M00561411	TWISTER PLUS Rotatable Retrieval Device	64
M00561412	TWISTER PLUS Rotatable Retrieval Device	64
M00561421	TWISTER PLUS Rotatable Retrieval Device	64
M00561422	TWISTER PLUS Rotatable Retrieval Device	64
	Electrosurgical Bipolar Cable Adaptors	
M00561440	Bipolar Cable Adaptor	59
M00561450	Bipolar Cable Adaptor	59
M00561460	Bipolar Cable Adaptor	59
M00561470	Bipolar Cable Adaptor	59
M00561480	Bipolar Cable Adaptor	59
M00561490	Bipolar Cable Adaptor	59
M00561500	Bipolar Cable Adaptor	59
	Rotatable Snares	
M00561821	Small Oval	61
M00561831	Medium Oval	61
	Captivator™ Snares	
M00562301	Small Oval	62
M00562321	Medium Oval	62
M00562341	Medium Hexagonal	62
M00562371	Medium Crescent	62
M00562391	Large Oval (thin wire)	62
	Captiflex™ Snares	
M00562401	Medium Oval	62
M00562402	Medium Oval	62
M00562421	Small Oval	62
M00562422	Small Oval	62
	Captivator™ Snares	
M00562451	Small Hexagonal	62
	Captiflex™ Snares	
M00562471	Extra Small Oval	62
	Profile™ Pediatric Snares	
M00562531	Extra Small Oval	63
M00562551	Small Oval	63
M00562571	Medium Oval	63



Product Code Index (CONTINUED)

Order Number	Description	Page Number
Sensation™ Short Throw Snares		
M00562651	Large Oval	61
M00562652	Large Oval	61
M00562671	Medium Oval	61
M00562672	Medium Oval	61
M00562673	Medium Oval	61
M00562691	Small Oval	61
M00562692	Small Oval	61
M00562693	Small Oval	61
eXcelon™ Transbronchial Aspiration Needle with Syringe		
M00564101	eXcelon Transbronchial Aspiration Needle w/Syringe	77
M00564111	eXcelon Transbronchial Aspiration Needle w/Syringe	77
M00564121	eXcelon Transbronchial Aspiration Needle w/Syringe	77
Ultraflex™ Non-Covered Tracheobronchial NG Stents – Distal Release – Bronchial Stents		
M00564500	Ultraflex Bronchial NG Stent	75
M00564510	Ultraflex Bronchial NG Stent	75
M00564520	Ultraflex Bronchial NG Stent	75
Ultraflex™ Non-Covered Tracheobronchial NG Stents – Distal Release – Tracheal Stents		
M00564530	Ultraflex Tracheal NG Stent	75
M00564540	Ultraflex Tracheal NG Stent	75
M00564560	Ultraflex Tracheal NG Stent	75
M00564570	Ultraflex Tracheal NG Stent	75
M00564590	Ultraflex Tracheal NG Stent	75
M00564600	Ultraflex Tracheal NG Stent	75
Ultraflex™ Non-Covered Tracheobronchial NG Stents – Proximal Release – Bronchial Stents		
M00564640	Ultraflex Bronchial NG Stent	75
M00564650	Ultraflex Bronchial NG Stent	75
M00564660	Ultraflex Bronchial NG Stent	75
M00564670	Ultraflex Bronchial NG Stent	75
M00564680	Ultraflex Bronchial NG Stent	75
M00564690	Ultraflex Bronchial NG Stent	75
M00564700	Ultraflex Bronchial NG Stent	75
Ultraflex™ Non-Covered Tracheobronchial NG Stents – Proximal Release – Tracheal Stents		
M00564710	Ultraflex Tracheal NG Stent	75
M00564720	Ultraflex Tracheal NG Stent	75
Ultraflex™ Covered Tracheobronchial NG Stents – Distal Release – Bronchial Stents		
M00564740	Ultraflex Bronchial NG Stent	74
M00564750	Ultraflex Bronchial NG Stent	74
M00564760	Ultraflex Bronchial NG Stent	74
M00564770	Ultraflex Bronchial NG Stent	74
M00564780	Ultraflex Bronchial NG Stent	74
M00564790	Ultraflex Bronchial NG Stent	74
M00564800	Ultraflex Bronchial NG Stent	74
M00564810	Ultraflex Bronchial NG Stent	74



Product Code Index (CONTINUED)

Order Number	Description	Page Number
Ultraflex™ Covered Tracheobronchial NG Stents – Distal Release – Tracheal Stents		
M00564820	Ultraflex Tracheal NG Stent	74
M00564830	Ultraflex Tracheal NG Stent	74
M00564840	Ultraflex Tracheal NG Stent	74
M00564850	Ultraflex Tracheal NG Stent	74
M00564860	Ultraflex Tracheal NG Stent	74
M00564870	Ultraflex Tracheal NG Stent	74
M00564880	Ultraflex Tracheal NG Stent	74
M00564890	Ultraflex Tracheal NG Stent	74
M00564900	Ultraflex Tracheal NG Stent	74
M00564910	Ultraflex Tracheal NG Stent	74
WallFlex™ Duodenal Stents		
M00565010	WallFlex Duodenal Stent	42
M00565020	WallFlex Duodenal Stent	42
M00565030	WallFlex Duodenal Stent	42
WallFlex™ Colonic Stents		
M00565040	WallFlex Colonic Stent	42
M00565050	WallFlex Colonic Stent	42
M00565060	WallFlex Colonic Stent	42
M00565070	WallFlex Colonic Stent	42
M00565080	WallFlex Colonic Stent	42
M00565090	WallFlex Colonic Stent	42
M00565100	WallFlex Colonic Stent	42
M00565110	WallFlex Colonic Stent	42
M00565120	WallFlex Colonic Stent	42
M00565130	WallFlex Colonic Stent	42
M00565140	WallFlex Colonic Stent	42
M00565150	WallFlex Colonic Stent	42
Wallstent™ Colonic and Duodenal Stents		
M00565560	Wallstent Colonic and Duodenal Stent	43
M00565570	Wallstent Colonic and Duodenal Stent	43
M00565580	Wallstent Colonic and Duodenal Stent	43
M00565590	Wallstent Colonic and Duodenal Stent	43
M00565620	Wallstent Colonic and Duodenal Stent	43
M00565630	Wallstent Colonic and Duodenal Stent	43
M00565640	Wallstent Colonic and Duodenal Stent	43
M00565650	Wallstent Colonic and Duodenal Stent	43
Accessories		
M00566001	Rapid Refill Continuous Injection System	8, 16
Through-The-PEG (TTP) Jejunal Feeding Tube		
M00566320	8.5F (2.83mm) TTP Jejunal Feeding Tube	70
M00566330	8.5F (2.83mm) TTP Jejunal Feeding Tube	70
M00566340	12F (4.00mm) TTP Jejunal Feeding Tube	70
M00566350	12F (4.00mm) TTP Jejunal Feeding Tube	70



Product Code Index (CONTINUED)

Order Number	Description	Page Number
Accessories		
M00566670	Encore™ 26 Inflation Device	8, 16
Max Force™ Biliary Dilation Balloons		
M00567330	Max Force Dilation Balloon	16
M00567340	Max Force Dilation Balloon	16
M00567370	Max Force Dilation Balloon	16
M00567380	Max Force Dilation Balloon	16
M00567410	Max Force Dilation Balloon	16
M00567420	Max Force Dilation Balloon	16
Low Profile Button Replacements		
M00568170	28F (9.33mm) Low Profile Button Replacement	71
M00568180	28F (9.33mm) Low Profile Button Replacement	71
M00568190	28F (9.33mm) Low Profile Button Replacement	71
M00568260	18F (6.00mm) Low Profile Button Replacement	71
M00568270	18F (6.00mm) Low Profile Button Replacement	71
M00568280	18F (6.00mm) Low Profile Button Replacement	71
M00568290	18F (6.00mm) Low Profile Button Replacement	71
M00568300	18F (6.00mm) Low Profile Button Replacement	71
M00568320	24F (8.00mm) Low Profile Button Replacement	71
M00568330	24F (8.00mm) Low Profile Button Replacement	71
M00568340	24F (8.00mm) Low Profile Button Replacement	71
M00568350	24F (8.00mm) Low Profile Button Replacement	71
Standard PEGs		
M00568381	20F (6.67mm) Standard PEG Kit, Pull	69
M00568391	24F (8.00mm) Standard PEG Kit, Pull	69
M00568401	20F (6.67mm) Standard PEG Kit, Push	69
M00568411	24F (8.00mm) Standard PEG Kit, Push	69
One Step Button Low Profile PEG Kits		
M00568450	18F (6.00mm) One Step Button Kit, Pull	69
M00568460	18F (6.00mm) One Step Button Kit, Pull	69
M00568470	18F (6.00mm) One Step Button Kit, Pull	69
M00568480	18F (6.00mm) One Step Button Kit, Pull	69
M00568500	24F (8.00mm) One Step Button Kit, Pull	69
M00568510	24F (8.00mm) One Step Button Kit, Pull	69
M00568520	24F (8.00mm) One Step Button Kit, Pull	69
M00568530	24F (8.00mm) One Step Button Kit, Pull	69
M00568560	18F (6.00mm) One Step Button Kit, Push	69
M00568570	18F (6.00mm) One Step Button Kit, Push	69
M00568580	18F (6.00mm) One Step Button Kit, Push	69
M00568600	24F (8.00mm) One Step Button Kit, Push	69
M00568610	24F (8.00mm) One Step Button Kit, Push	69
M00568620	24F (8.00mm) One Step Button Kit, Push	69
M00568630	24F (8.00mm) One Step Button Kit, Push	69



Product Code Index (CONTINUED)

Order Number	Description	Page Number
Wallstent™ RX Biliary Stents		
M00569610	Wallstent RX Biliary	25
M00569620	Wallstent RX Biliary	25
M00569630	Wallstent RX Biliary	25
M00569640	Wallstent RX Biliary	25
M00569650	Wallstent RX Biliary	25
M00569660	Wallstent RX Biliary	25
Wallstent™ RX Biliary Stents with Permalume™ Covering		
M00569670	Wallstent RX w/Permalume	25
M00569680	Wallstent RX w/Permalume	25
M00569690	Wallstent RX w/Permalume	25
M00569700	Wallstent RX w/Permalume	25
M00569710	Wallstent RX w/Permalume	25
M00569720	Wallstent RX w/Permalume	25
Wallstent™ RX Biliary Stents		
M00569800	Wallstent RX Biliary	25
M00569810	Wallstent RX Biliary	25
Polyflex Stent™ Self-expanding Silicone Airway Stents		
M00570000	Polyflex Airway Stent	76
M00570010	Polyflex Airway Stent	76
M00570020	Polyflex Airway Stent	76
M00570030	Polyflex Airway Stent	76
M00570040	Polyflex Airway Stent	76
M00570050	Polyflex Airway Stent	76
M00570060	Polyflex Airway Stent	76
M00570070	Polyflex Airway Stent	76
M00570080	Polyflex Airway Stent	76
M00570090	Polyflex Airway Stent	76
M00570100	Polyflex Airway Stent	76
M00570110	Polyflex Airway Stent	76
M00570120	Polyflex Airway Stent	76
M00570130	Polyflex Airway Stent	76
M00570140	Polyflex Airway Stent	76
M00570150	Polyflex Airway Stent	76
M00570160	Polyflex Airway Stent	76
M00570170	Polyflex Airway Stent	76
M00570180	Polyflex Airway Stent	76
M00570190	Polyflex Airway Stent	76
M00570200	Polyflex Airway Stent	76
M00570210	Polyflex Airway Stent	76
M00570220	Polyflex Airway Stent	76
M00570230	Polyflex Airway Stent	76
M00570240	Polyflex Airway Stent	76
M00570250	Polyflex Airway Stent	76



Product Code Index (CONTINUED)

Order Number	Description	Page Number
Polyflex Stent™ Self-expanding Silicone Airway Stents <small>(CONTINUED)</small>		
M00570260	Polyflex Airway Stent	76
M00570270	Polyflex Airway Stent	76
M00570280	Polyflex Airway Stent	76
M00570290	Polyflex Airway Stent	76
M00570300	Polyflex Airway Stent	76
M00570310	Polyflex Airway Stent	76
M00570320	Polyflex Airway Stent	76
M00570330	Polyflex Airway Stent	76
WallFlex™ Biliary RX Fully Covered Stents with Permalume™ Covering (including benign indication)		
M00570450	WallFlex RX Biliary w/Permalume	23
M00570460	WallFlex RX Biliary w/Permalume	23
M00570470	WallFlex RX Biliary w/Permalume	23
M00570480	WallFlex RX Biliary w/Permalume	23
M00570490	WallFlex RX Biliary w/Permalume	23
WallFlex™ Biliary RX Fully Covered Stents with Permalume™ Covering		
M00570500	WallFlex RX Biliary w/Permalume	44
M00570510	WallFlex RX Biliary w/Permalume	44
M00570520	WallFlex RX Biliary w/Permalume	44
M00570530	WallFlex RX Biliary w/Permalume	44
M00570540	WallFlex RX Biliary w/Permalume	44
WallFlex™ Biliary RX Non-covered Stents		
M00570600	WallFlex RX Biliary	24
M00570610	WallFlex RX Biliary	24
M00570620	WallFlex RX Biliary	24
M00570630	WallFlex RX Biliary	24
M00570640	WallFlex RX Biliary	24
M00570650	WallFlex RX Biliary	24
M00570660	WallFlex RX Biliary	24
Dynamic™ (Y) Stents		
M00570670	Dynamic (Y) Stent	74
M00570680	Dynamic (Y) Stent	74
M00570690	Dynamic (Y) Stent	74
WallFlex™ Biliary RX Partially Covered Stents with Permalume™ Covering		
M00570700	WallFlex RX Biliary w/Permalume	23
M00570710	WallFlex RX Biliary w/Permalume	23
M00570720	WallFlex RX Biliary w/Permalume	23
M00570730	WallFlex RX Biliary w/Permalume	23
M00570740	WallFlex RX Biliary w/Permalume	23
WallFlex™ Biliary RX Non-covered Stents		
M00570890	WallFlex RX Biliary	24
Jagtome™ RX Cannulating Sphincterotomes with Pre-loaded Jagwire™ Guidewire		
M00573000	Jagtome RX 49	4
M00573010	Jagtome RX 49	4



Product Code Index (CONTINUED)

Order Number	Description	Page Number
Jagtome™ RX Cannulating Sphincterotomes with Pre-loaded Jagwire™ Guidewire (CONTINUED)		
M00573020	Jagtome RX 49	4
M00573030	Jagtome RX 49	4
M00573040	Jagtome RX 44	4
M00573050	Jagtome RX 44	4
M00573060	Jagtome RX 44	4
M00573070	Jagtome RX 44	4
M00573080	Jagtome RX 39	4
M00573090	Jagtome RX 39	4
M00573100	Jagtome RX 39	4
M00573110	Jagtome RX 39	4
M00573500	Jagtome RX 49	4
M00573510	Jagtome RX 49	4
M00573520	Jagtome RX 49	4
M00573530	Jagtome RX 49	4
M00573540	Jagtome RX 44	4
M00573550	Jagtome RX 44	4
M00573560	Jagtome RX 44	4
M00573570	Jagtome RX 44	4
WallFlex™ Biliary RX Partially Covered Stents with Permalume™ Covering		
M00576740	WallFlex RX Biliary w/Permalume	23
M00576750	WallFlex RX Biliary w/Permalume	23
M00576760	WallFlex RX Biliary w/Permalume	23
M00576770	WallFlex RX Biliary w/Permalume	23
WallFlex™ Biliary RX Non-covered Stents		
M00576780	WallFlex RX Biliary	24
M00576790	WallFlex RX Biliary	24
WallFlex™ Biliary RX Fully Covered Stents with Permalume™ Covering (including benign indication)		
M00576800	WallFlex RX Biliary w/Permalume	23
M00576810	WallFlex RX Biliary w/Permalume	23
M00576820	WallFlex RX Biliary w/Permalume	23
M00576830	WallFlex RX Biliary w/Permalume	23
One Step Button and Low Profile Button Accessories		
M00580171	18F (6.00mm) Bolus Straight Feeding Adapter	70
M00580181	18F (6.00mm) Continuous Right Angle Feeding Adapter	70
M00580231	24F (8.00mm) Bolus Straight Feeding Adapter	70
M00580241	24F (8.00mm) Continuous Right Angle Feeding Adapter	70
M00580271	28F (9.33mm) Bolus Straight Feeding Adapter	70
M00580281	28F (9.33mm) Continuous Right Angle Feeding Adapter	70
M00580401	18F (6.00mm) Decompression Tube	70
M00580411	18F (6.00mm) Decompression Tube	70
M00580421	18F (6.00mm) Decompression Tube	70
M00580431	18F (6.00mm) Decompression Tube	70
M00580441	18F (6.00mm) Decompression Tube	70

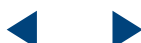

Product Code Index (CONTINUED)

Order Number	Description	Page Number
One Step Button and Low Profile Button Accessories (CONTINUED)		
M00580461	24F (8.00mm) Decompression Tube	70
M00580471	24F (8.00mm) Decompression Tube	70
M00580481	24F (8.00mm) Decompression Tube	70
M00580491	24F (8.00mm) Decompression Tube	70
PEG/Replacement PEG Accessories		
M00580641	20F (6.67mm) Y-Ports	69
M00580651	24F (8.00mm) Y-Ports	69
M00580731	20F (6.67mm) Round Bolsters	69
M00580781	20F (6.67mm) and 24F (8.00mm) C-Clamps	69
Standard Balloon Replacements		
M00582050	14F (4.67mm) Replacement G-Tube, Straight	71
M00582060	16F (5.33mm) Replacement G-Tube, Straight	71
M00582070	18F (6.00mm) Replacement G-Tube, Straight	71
M00582080	20F (6.67mm) Replacement G-Tube, Straight	71
M00582090	24F (8.00mm) Replacement G-Tube, Straight	71
M00582100	28F (9.33mm) Replacement G-Tube, Straight	71
M00582120	14F (4.67mm) Replacement G-Tube, Right-Angle	71
M00582130	16F (5.33mm) Replacement G-Tube, Right-Angle	71
M00582140	18F (6.00mm) Replacement G-Tube, Right-Angle	71
M00582150	20F (6.67mm) Replacement G-Tube, Right-Angle	71
M00582160	24F (8.00mm) Replacement G-Tube, Right-Angle	71
M00582170	28F (9.33mm) Replacement G-Tube, Right-Angle	71
M00582860	22F (7.33mm) Replacement G-Tube, Straight	71
M00582870	22F (7.33mm) Replacement G-Tube, Right-Angle	71
Hydratome™ RX Cannulating Sphincterotomes with Pre-loaded Hydra Jagwire™ Guidewire		
M00583000	Hydratome RX 49	3
M00583010	Hydratome RX 49	3
M00583020	Hydratome RX 49	3
M00583030	Hydratome RX 49	3
M00583040	Hydratome RX 44	3
M00583050	Hydratome RX 44	3
M00583060	Hydratome RX 44	3
M00583070	Hydratome RX 44	3
TRUEtome™ Jag Cannulating Sphincterotomes with Pre-loaded Jagwire™ Guidewire		
M00583080	TRUEtome 39 Sphincterotome	12
M00583090	TRUEtome 44 Sphincterotome	12
M00583100	TRUEtome 44 Sphincterotome	12
M00583110	TRUEtome 44 Sphincterotome	12
M00583120	TRUEtome 39 Sphincterotome	12
M00583130	TRUEtome 44 Sphincterotome	12
M00583140	TRUEtome 44 Sphincterotome	12
M00583150	TRUEtome 44 Sphincterotome	12



Product Code Index (CONTINUED)

Order Number	Description	Page Number
TRUEtome™ Hydra Cannulating Sphincterotomes with Pre-loaded Hydra Jagwire™ Guidewire		
M00583160	TRUEtome 44 Sphincterotome	12
M00583170	TRUEtome 44 Sphincterotome	12
TRUEtome™ Dreamwire Cannulating Sphincterotomes with Pre-loaded Dreamwire™ Guidewire		
M00583190	TRUEtome 44 Sphincterotome	12
M00583210	TRUEtome 44 Sphincterotome	12
Dreamtome™ RX Cannulating Sphincterotomes with Pre-loaded Dreamwire™ Guidewire		
M00584000	Dreamtome RX 49	3
M00584010	Dreamtome RX 49	3
M00584020	Dreamtome RX 49	3
M00584030	Dreamtome RX 49	3
M00584040	Dreamtome RX 44	3
M00584050	Dreamtome RX 44	3
M00584060	Dreamtome RX 44	3
M00584070	Dreamtome RX 44	3
TRUEtome™ Cannulating Sphincterotomes		
M00584120	TRUEtome 39	13
M00584121	TRUEtome 39	13
M00584122	TRUEtome 39	13
M00584150	TRUEtome 49	13
M00584151	TRUEtome 49	13
M00584152	TRUEtome 49	13
M00584160	TRUEtome 49	13
M00584161	TRUEtome 49	13
M00584162	TRUEtome 49	13
M00584170	TRUEtome 44	13
M00584171	TRUEtome 44	13
M00584172	TRUEtome 44	13
M00584180	TRUEtome 44	13
M00584181	TRUEtome 44	13
M00584182	TRUEtome 44	13
M00584190	TRUEtome 39	13
M00584191	TRUEtome 39	13
M00584192	TRUEtome 39	13
Max Force™ TTS Esophageal Dilation Balloons		
M00589060	Max Force TTS Dilation Balloon	48
M00589080	Max Force TTS Dilation Balloon	48
M00589100	Max Force TTS Dilation Balloon	48
M00589120	Max Force TTS Dilation Balloon	48
M00589140	Max Force TTS Dilation Balloon	48
M00589150	Max Force TTS Dilation Balloon	48
M00589160	Max Force TTS Dilation Balloon	48
M00589180	Max Force TTS Dilation Balloon	48



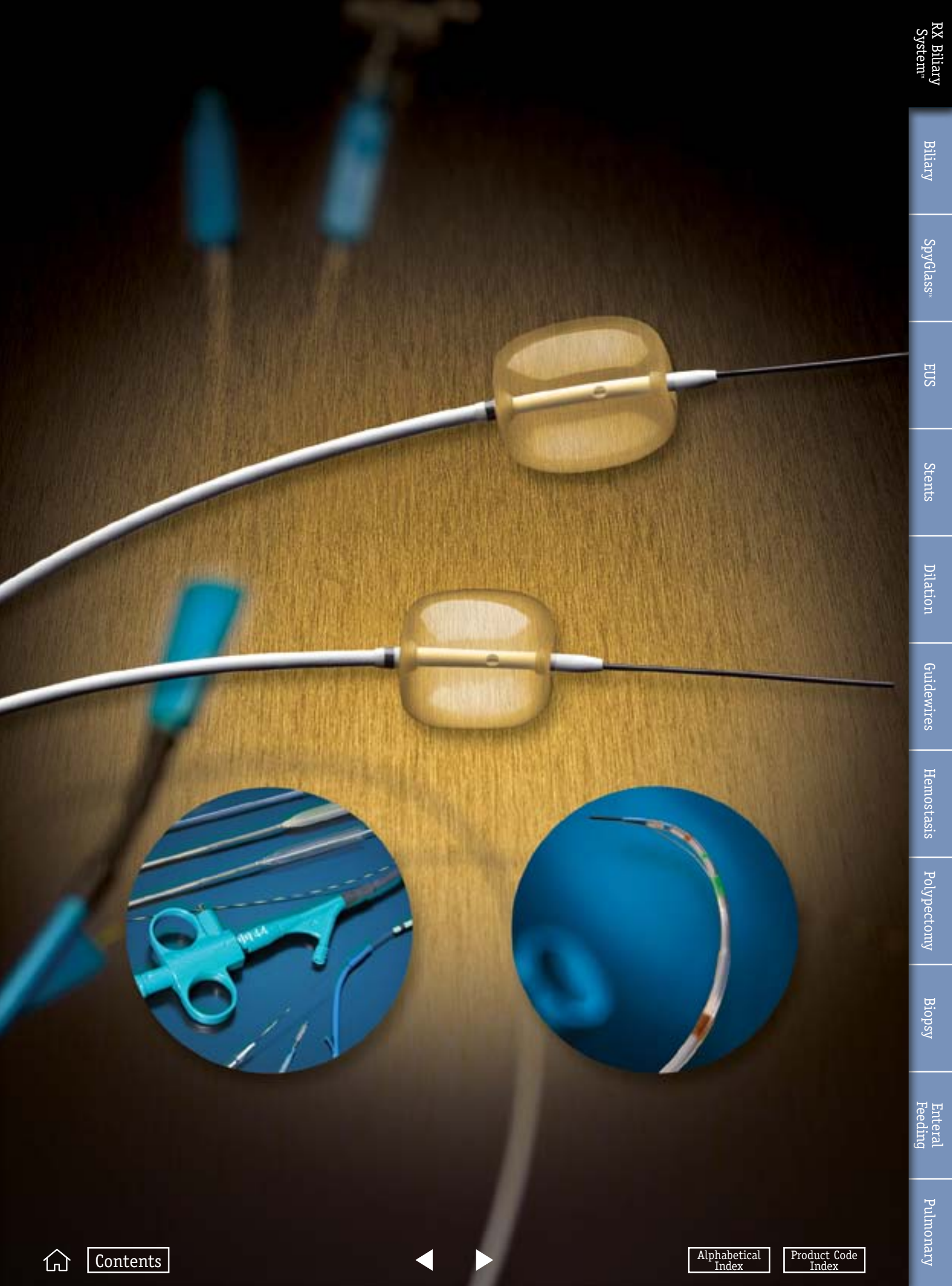

RX Biliary System™

CANNULAS

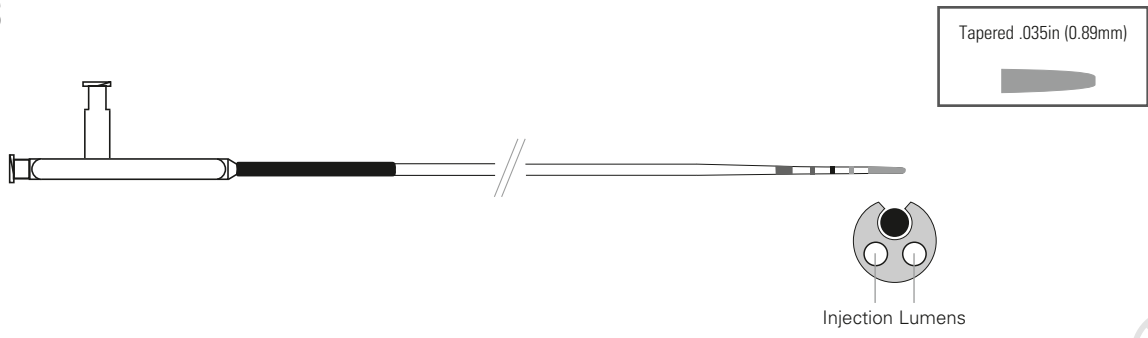

Tandem™ RX Cannula

Order Number	Description	Shaft O.D. (F) / (mm)	Length (cm)	Recommended Guidewire (in) / (mm)
M00545820	Tandem RX Cannula	7-5.5 / 2.33-1.84	210	.035 / 0.89

Packaged one per box

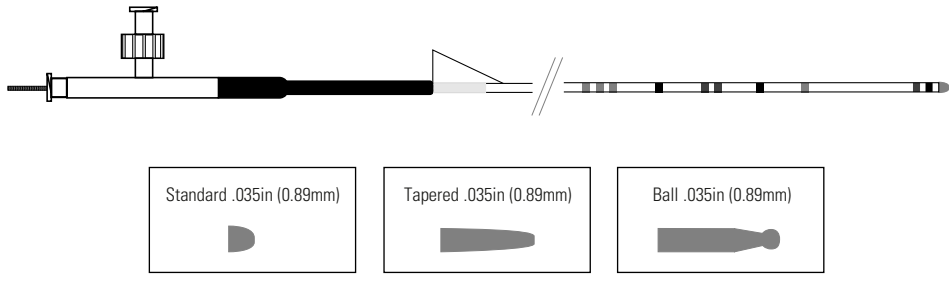

RX Cannulas

Order Number	Description	Shaft O.D. (F) / (mm)	Length (cm)	Recommended Guidewire (in) / (mm)
M00545760	RX Standard ERCP Cannula	8.5-5 / 2.83-1.67	210	.035 / 0.89
M00545770	RX Tapered ERCP Cannula	8.5-5 / 2.83-1.67	210	.035 / 0.89
M00545780	RX Ball Tip ERCP Cannula	8.5-5 / 2.83-1.67	210	.035 / 0.89

Packaged one per box

RX Biliary System™

SPHINCTEROTOMES

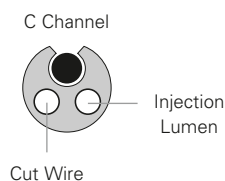
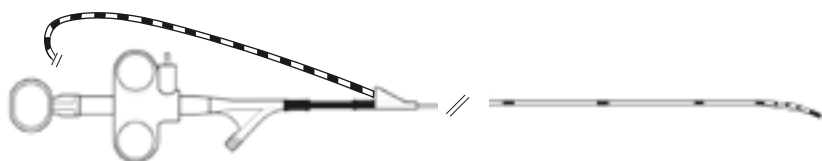

Hydratome™ RX Cannulating Sphincterotomes with Pre-loaded Hydra Jagwire™ Guidewire



Order Number	Description	Cut Wire (mm)	Shaft O.D. (F) / (mm)	Tip Length (mm)	Tip Diameter (F) / (mm)	Catheter Length (cm)	Pre-loaded Guidewire** Length (cm)	O.D. (in) / (mm)
M00583000	Hydratome RX 49	20	7-5.5 / 2.33-1.83	5	4.9 / 1.63	200	260	.035 / 0.89
M00583010	Hydratome RX 49	30	7-5.5 / 2.33-1.83	5	4.9 / 1.63	200	260	.035 / 0.89
M00583020	Hydratome RX 49	20	7-5.5 / 2.33-1.83	5	4.9 / 1.63	200	450	.035 / 0.89
M00583030	Hydratome RX 49	30	7-5.5 / 2.33-1.83	5	4.9 / 1.63	200	450	.035 / 0.89
M00583040*	Hydratome RX 44	20	7-5.5 / 2.33-1.83	5	4.4 / 1.47	200	260	.035 / 0.89
M00583050*	Hydratome RX 44	30	7-5.5 / 2.33-1.83	5	4.4 / 1.47	200	260	.035 / 0.89
M00583060*	Hydratome RX 44	20	7-5.5 / 2.33-1.83	5	4.4 / 1.47	200	450	.035 / 0.89
M00583070*	Hydratome RX 44	30	7-5.5 / 2.33-1.83	5	4.4 / 1.47	200	450	.035 / 0.89

Packaged one per box
* Includes handle brake.

** Pre-loaded with .035in (0.89mm) Hydra Jagwire™ Guidewire.

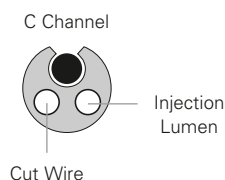
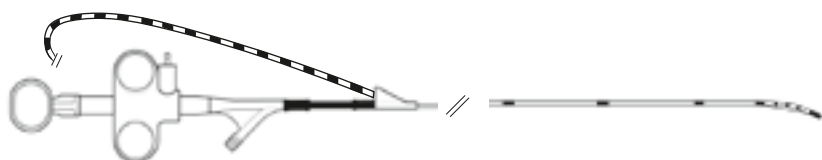

Dreamtome™ RX Cannulating Sphincterotomes with Pre-loaded Dreamwire™ Guidewire



Order Number	Description	Cut Wire (mm)	Tip Length (mm)	Tip Diameter (F) / (mm)	Pre-loaded Guidewire** Length (cm)	O.D. (in) / (mm)
M00584000	Dreamtome RX 49	20	5	4.9 / 1.63	260	.035 / 0.89
M00584010	Dreamtome RX 49	30	5	4.9 / 1.63	260	.035 / 0.89
M00584020	Dreamtome RX 49	20	5	4.9 / 1.63	450	.035 / 0.89
M00584030	Dreamtome RX 49	30	5	4.9 / 1.63	450	.035 / 0.89
M00584040*	Dreamtome RX 44	20	5	4.4 / 1.47	260	.035 / 0.89
M00584050*	Dreamtome RX 44	30	5	4.4 / 1.47	260	.035 / 0.89
M00584060*	Dreamtome RX 44	20	5	4.4 / 1.47	450	.035 / 0.89
M00584070*	Dreamtome RX 44	30	5	4.4 / 1.47	450	.035 / 0.89

Packaged one per box
* Includes handle brake.

** Pre-loaded with Straight-tip guidewires only.

RX Biliary System™

SPHINCTEROTOMES (CONTINUED)



Jagtome™ RX Cannulating Sphincterotomes with Pre-loaded Jagwire™ Guidewire



Order Number	Description	Cut Wire (mm)	Shaft O.D. (F) / (mm)	Tip Length (mm)	Tip Diameter (F) / (mm)	Catheter Length (cm)	Pre-loaded Guidewire**		
							Shaft Stiffness	Length (cm)	O.D. (in) / (mm)
M00573000	Jagtome RX 49	20	7-5.5 / 2.33-1.83	5	4.9 / 1.63	200	Standard	260	.035 / 0.89
M00573020	Jagtome RX 49	30	7-5.5 / 2.33-1.83	5	4.9 / 1.63	200	Standard	260	.035 / 0.89
M00573010	Jagtome RX 49	20	7-5.5 / 2.33-1.83	5	4.9 / 1.63	200	Standard	450	.035 / 0.89
M00573030	Jagtome RX 49	30	7-5.5 / 2.33-1.83	5	4.9 / 1.63	200	Standard	450	.035 / 0.89
M00573500	Jagtome RX 49	20	7-5.5 / 2.33-1.83	5	4.9 / 1.63	200	Stiff	260	.035 / 0.89
M00573520	Jagtome RX 49	30	7-5.5 / 2.33-1.83	5	4.9 / 1.63	200	Stiff	260	.035 / 0.89
M00573510	Jagtome RX 49	20	7-5.5 / 2.33-1.83	5	4.9 / 1.63	200	Stiff	450	.035 / 0.89
M00573530	Jagtome RX 49	30	7-5.5 / 2.33-1.83	5	4.9 / 1.63	200	Stiff	450	.035 / 0.89
M00573040†	Jagtome RX 44	20	7-5.5 / 2.33-1.83	5	4.4 / 1.47	200	Standard	260	.035 / 0.89
M00573060†	Jagtome RX 44	30	7-5.5 / 2.33-1.83	5	4.4 / 1.47	200	Standard	260	.035 / 0.89
M00573050†	Jagtome RX 44	20	7-5.5 / 2.33-1.83	5	4.4 / 1.47	200	Standard	450	.035 / 0.89
M00573070†	Jagtome RX 44	30	7-5.5 / 2.33-1.83	5	4.4 / 1.47	200	Standard	450	.035 / 0.89
M00573540†	Jagtome RX 44	20	7-5.5 / 2.33-1.83	5	4.4 / 1.47	200	Stiff	260	.035 / 0.89
M00573560†	Jagtome RX 44	30	7-5.5 / 2.33-1.83	5	4.4 / 1.47	200	Stiff	260	.035 / 0.89
M00573550†	Jagtome RX 44	20	7-5.5 / 2.33-1.83	5	4.4 / 1.47	200	Stiff	450	.035 / 0.89
M00573570†	Jagtome RX 44	30	7-5.5 / 2.33-1.83	5	4.4 / 1.47	200	Stiff	450	.035 / 0.89
M00573080†	Jagtome RX 39	20	7-5.5 / 2.33-1.83	5	3.9 / 1.30	200	Stiff	260	.025 / 0.64
M00573100†	Jagtome RX 39	30	7-5.5 / 2.33-1.83	5	3.9 / 1.30	200	Stiff	260	.025 / 0.64
M00573090†	Jagtome RX 39	20	7-5.5 / 2.33-1.83	5	3.9 / 1.30	200	Standard	450	.025 / 0.64
M00573110†	Jagtome RX 39	30	7-5.5 / 2.33-1.83	5	3.9 / 1.30	200	Standard	450	.025 / 0.64

Packaged one per box

* Includes handle brake.

** Pre-loaded with the high performance Jagwire™ Guidewire (Jagtome RX 49 and RX 44 contain the Stiff Shaft Jagwire and Jagtome RX 39 the Standard Jagwire).

RX Biliary System™

SPHINCTEROTOMES (CONTINUED)

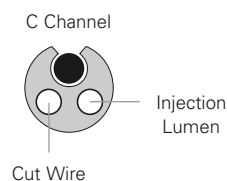

Autotome™ RX Cannulating Sphincterotomes



Order Number	Description	Cut Wire (mm)	Shaft O.D. (F) / (mm)	Tip Length (mm)	Tip Diameter (F) / (mm)	Catheter Length (cm)	Recommended Guidewire (in) / (mm)
M00545150	Autotome RX 49	20	7-5.5 / 2.33-1.83	5	4.9 / 1.63	200	.035 / 0.89
M00545160	Autotome RX 49	30	7-5.5 / 2.33-1.83	5	4.9 / 1.63	200	.035 / 0.89
M00545170*	Autotome RX 44	20	7-5.5 / 2.33-1.83	5	4.4 / 1.47	200	.035 / 0.89
M00545180*	Autotome RX 44	30	7-5.5 / 2.33-1.83	5	4.4 / 1.47	200	.035 / 0.89
M00545190*	Autotome RX 39	20	7-5.5 / 2.33-1.83	5	3.9 / 1.30	200	.025 / 0.64
M00545200*	Autotome RX 39	30	7-5.5 / 2.33-1.83	5	3.9 / 1.30	200	.025 / 0.64

Packaged one per box

Recommended Guidewires: For Autotome RX 44 and 49, recommended guidewire is .035in (0.89mm) Dreamwire™ High Performance Guidewire
For Autotome RX 39, recommended guidewire is .025in (0.69mm) Jagwire™ Guidewire

* Includes handle brake.

RX Triple-lumen Needleknife



Order Number	Description	Cut Wire (mm)	Shaft O.D. (F) / (mm)	Tip Length (mm)	Tip Diameter (F) / (mm)
M00545840	Needleknife RX	4-6	7-5.5 / 2.3-1.83	5	5 / 1.67

Packaged one per box

Recommended Guidewire: .035 in (0.89mm) Dreamwire™ High Performance Guidewire

RX Biliary System™

STONE RETRIEVAL

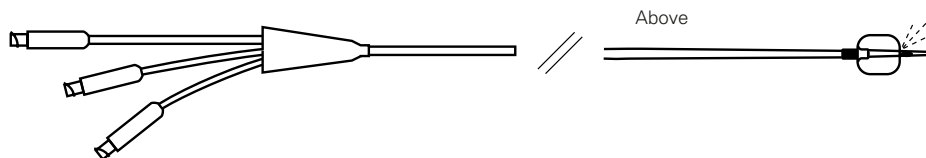

Extractor™ Pro RX Triple-lumen Retrieval Balloons – Distal Injection



Order Number	Description	Balloon O.D. (mm)	Injection	Catheter O.D. (F) / (mm)	System Length (cm)
M00547000	Extractor Pro RX Triple-lumen Retrieval Balloon	9.0-12.0	Above	7-6 / 2.33-2.00	200
M00547010	Extractor Pro RX Triple-lumen Retrieval Balloon	12.0-15.0	Above	7-6 / 2.33-2.00	200
M00547020	Extractor Pro RX Triple-lumen Retrieval Balloon	15.0-18.0	Above	7-6 / 2.33-2.00	200

Packaged one per box

Recommended Guidewire: .035in (0.89mm) Dreamwire™ High Performance Guidewire

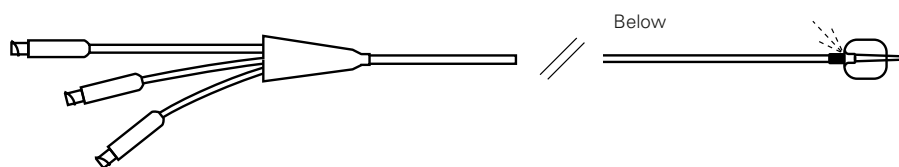

Extractor™ Pro RX Triple-lumen Retrieval Balloons – Proximal Injection



Order Number	Description	Balloon O.D. (mm)	Injection	Catheter O.D. (F) / (mm)	System Length (cm)
M00547030	Extractor Pro RX Triple-lumen Retrieval Balloon	9.0-12.0	Below	7-6 / 2.33-2.00	200
M00547040	Extractor Pro RX Triple-lumen Retrieval Balloon	12.0-15.0	Below	7-6 / 2.33-2.00	200
M00547050	Extractor Pro RX Triple-lumen Retrieval Balloon	15.0-18.0	Below	7-6 / 2.33-2.00	200

Packaged one per box

Recommended Guidewire: .035in (0.89mm) Dreamwire™ High Performance Guidewire

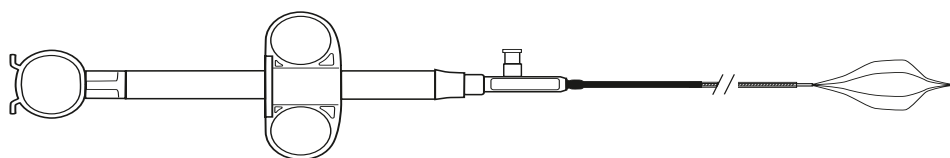

Trapezoid™ RX Wire-guided Retrieval Baskets



Order Number	Description	Open Basket Diameter (cm)	Required Working Channel (mm)
M00510860	Trapezoid RX Wire-guided Retrieval Basket	1.5	3.2
M00510870	Trapezoid RX Wire-guided Retrieval Basket	2.0	3.2
M00510880	Trapezoid RX Wire-guided Retrieval Basket	2.5	3.2
M00510890	Trapezoid RX Wire-guided Retrieval Basket	3.0	3.2
M00550620	Alliance™ II Inflation Handle**		

Packaged one per box

Recommended Guidewire: .035in (0.89mm) Dreamwire™ High Performance Guidewire

* The Trapezoid 3 x 6cm basket is designed for crushing calculus larger than 1.5cm in diameter.

** Alliance II recommended for use as Mechanical Lithotripter. Alliance II is reusable.

RX Biliary System™

DILATION

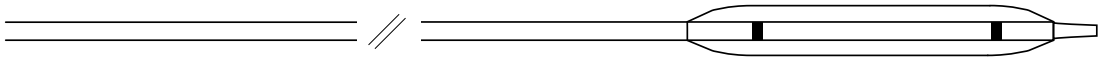

Hurricane™ RX Biliary Dilation Balloons

Order Number	Description	Balloon O.D. (mm)	Balloon Length (cm)	Catheter O.D. (F) / (mm)	Maximum Inflation Pressure (ATM) / (kPa)	Minimum Channel Size (mm)	Recommended Guidewire (in) / (mm)
M00545890	Hurricane RX Dilation Balloon	4	2	5.8 / 1.93	12 / 1216	3.2	.035 / 0.89
M00545900	Hurricane RX Dilation Balloon	4	4	5.8 / 1.93	12 / 1216	3.2	.035 / 0.89
M00545910	Hurricane RX Dilation Balloon	6	2	5.8 / 1.93	11 / 1114	3.2	.035 / 0.89
M00545920	Hurricane RX Dilation Balloon	6	4	5.8 / 1.93	11 / 1114	3.2	.035 / 0.89
M00545930	Hurricane RX Dilation Balloon	8	2	5.8 / 1.93	11 / 1114	3.2	.035 / 0.89
M00545940	Hurricane RX Dilation Balloon	8	4	5.8 / 1.93	11 / 1114	3.2	.035 / 0.89
M00545950	Hurricane RX Dilation Balloon	10	2	5.8 / 1.93	8 / 810	3.2	.035 / 0.89
M00545960	Hurricane RX Dilation Balloon	10	4	5.8 / 1.93	8 / 810	3.2	.035 / 0.89

Packaged one per box
Recommended Inflation Device: Encore™ 26 Inflation Device, M00566670

CYTOLOGY



RX Cytology Brush

Order Number	Description	Brush Width (mm)	Catheter O.D. (F) / (mm)	Working Length (cm)	Recommended Guidewire (in) / (mm)
M00545000	RX Cytology Brush	2.1	8 / 2.67	200	.035 / 0.89

Packaged one per box

RX Biliary System™

ACCESSORIES

RX Accessories



Order Number	Description	Units
M00545471	RX Locking Device	box 10
M00545211†	RX Locking Device – Olympus/Fujinon Brand Endoscope Compatible	box 10
M00545221†	RX Locking Device – Pentax Brand Endoscope Compatible	box 10
M00545261	RX Locking Device and Biopsy Cap System – Olympus Compatible	box 10
M00545271	RX Locking Device and Biopsy Cap System – Pentax Compatible	box 10
M00545281	RX Locking Device and Biopsy Cap System – Fujinon Compatible	box 10
M00566001	Rapid Refill Continuous Injection System	box 10

† Product not available in the European Economic Area (EEA), except in Greece. Not for use or distribution in the EEA, except in Greece. Please check availability of the product with your local sales representative or your local customer service.

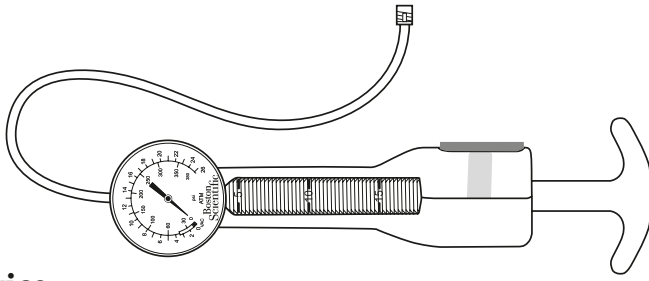

Encore™ 26 Inflation Device

Order Number	Description	Units
M00566670	Encore 26 Inflation Device	box 1

RX Biliary Metal and Plastic Stents are located in the Stents Section on pages 23 – 25 and 27 – 30

Biliary Guidewires are located in the Guidewires Section on page 52

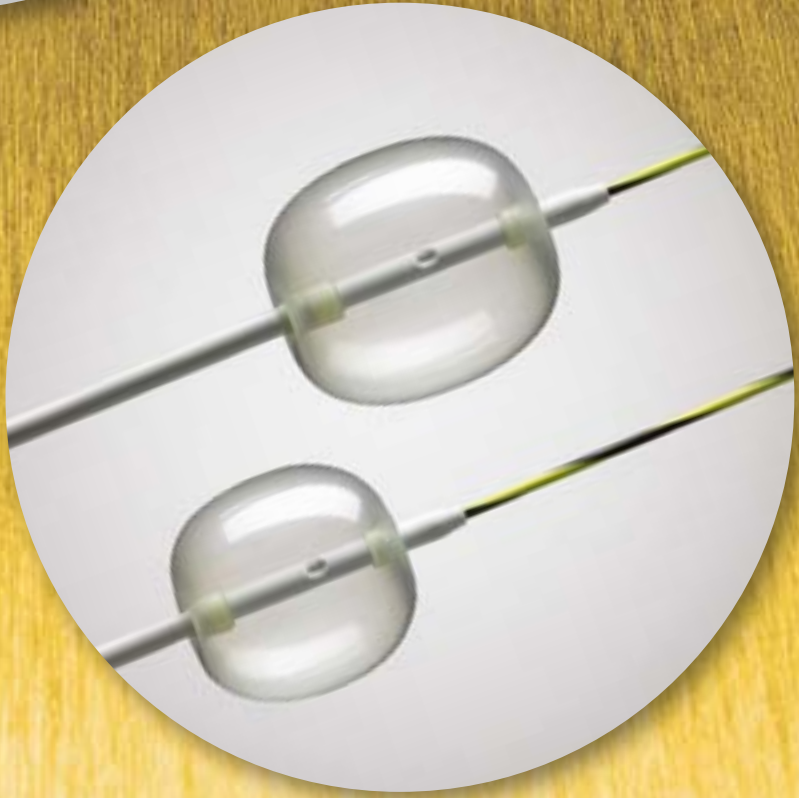
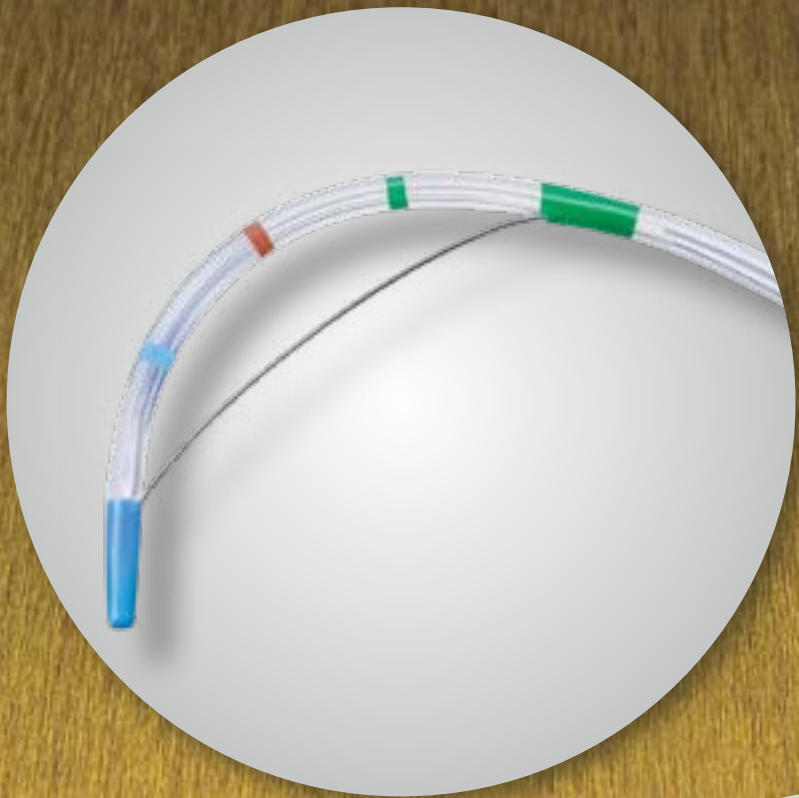

Biliary

CANNULAS

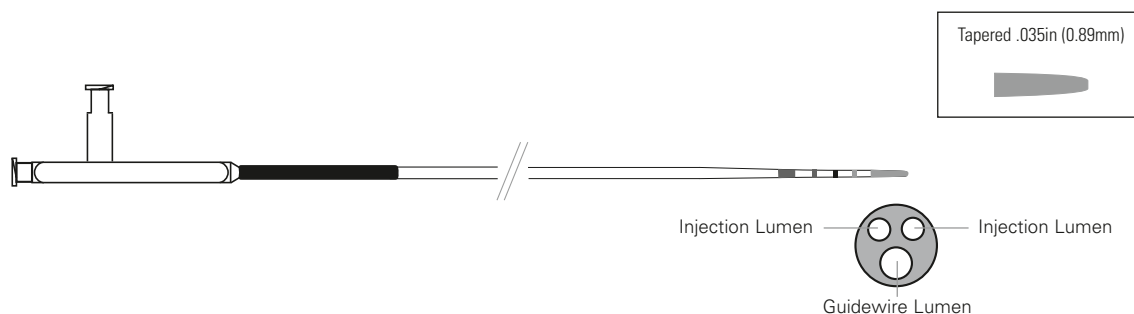

Tandem™ XL Triple-lumen ERCP Cannula

Order Number	Description	Shaft O.D. (F) / (mm)	Distal O.D. (F) / (mm)	Length (cm)	Tip	Recommended Guidewire (in) / (mm)
--------------	-------------	-----------------------	------------------------	-------------	-----	-----------------------------------

M00535700	Tandem XL Triple-lumen ERCP Cannula	7.0-5.5 / 2.33-1.83	5.5 / 1.83	210	Tapered	.035 / 0.89
-----------	-------------------------------------	---------------------	------------	-----	---------	-------------

Packaged one per box

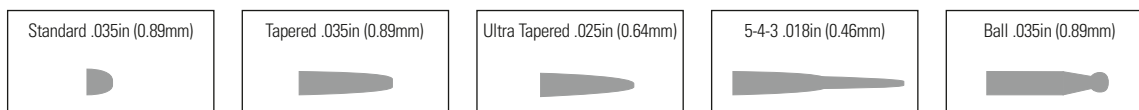

Contour™ ERCP Cannulas

Order Number	Description	Shaft O.D. (F) / (mm)	Length (cm)	Tip	Recommended Guidewire (in) / (mm)
--------------	-------------	-----------------------	-------------	-----	-----------------------------------

M00530850	Contour ERCP Cannula	5 / 1.67	210	Standard	.035 / 0.89
M00530860	Contour ERCP Cannula	5 / 1.67	210	Tapered	.035 / 0.89
M00530870	Contour ERCP Cannula	5 / 1.67	210	Ultra Tapered	.025 / 0.64
M00530880	Contour ERCP Cannula	5 / 1.67	210	5-4-3	.018 / 0.46
M00530890	Contour ERCP Cannula	5 / 1.67	210	Ball Tip	.035 / 0.89

Packaged one per box

Biliary

CANNULAS (CONTINUED)

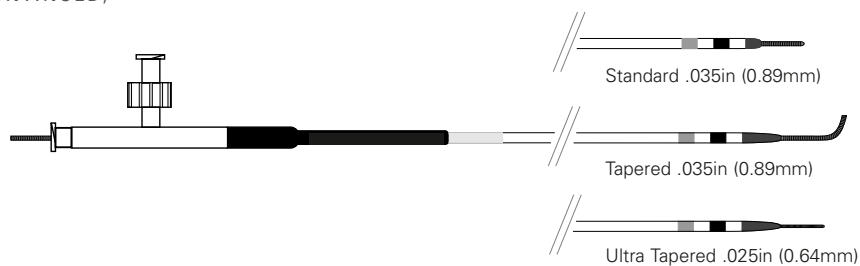

Fluoro Tip™ ERCP Cannulas



Order Number	Description	Shaft O.D. (F) / (mm)	Length (cm)	Recommended Guidewire (in) / (mm)
M00530960	Fluoro Tip ERCP Cannula, Standard Tip	5.5 / 1.83	210	.035 / 0.89
M00530970	Fluoro Tip ERCP Cannula, Tapered Tip	5.5 / 1.83	210	.035 / 0.89
M00530980	Fluoro Tip ERCP Cannula, Ultra Tapered Tip	5.5 / 1.83	210	.025 / 0.64

Packaged one per box

SPHINCTEROTOMES

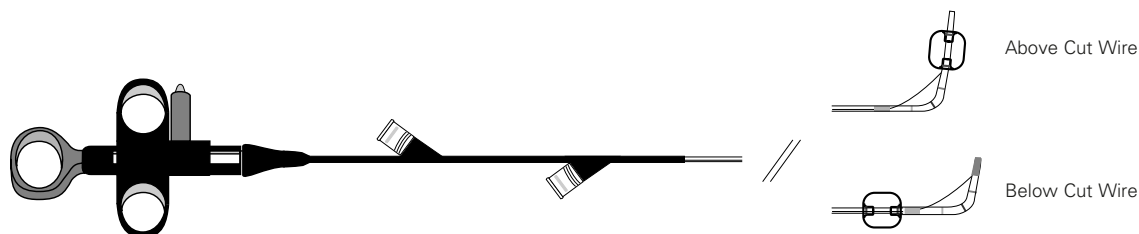

Stonetome™ Stone Removal Device



Order Number	Description	Cut Wire (mm)	Balloon Diameter (mm)	Tip Length (mm)	Catheter Length (cm)
M00535150	Stonetome (below cut wire)	20	11.5	5	200
M00535170	Stonetome (below cut wire)	20	11.5	20	200
M00535190	Stonetome (below cut wire)	30	11.5	5	200
M00535210	Stonetome (below cut wire)	30	11.5	20	200
M00535110	Stonetome (above cut wire)	20	11.5	20	200
M00535130	Stonetome (above cut wire)	30	11.5	20	200

Packaged one per box

Recommended Guidewire: .035in (0.89mm) Dreamwire™ High Performance Guidewire

Biliary

SPHINCTEROTOMES (CONTINUED)

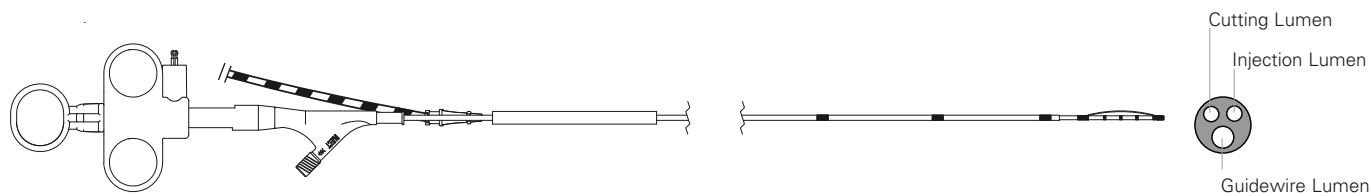

NEW TRUetome™ Jag Cannulating Sphincterotomes with Pre-loaded Jagwire™ Guidewire



Order Number	Description	Cut Wire (mm)	Tip O.D. (F) / (mm)	Tip Length (mm)	Pre-loaded Guidewire (in/cm)	Units
M00583080	TRUetome 39 Sphincterotome	20	3.9 / 1.30	5	.025/450 Jagwire Guidewire	box 1
M00583090	TRUetome 44 Sphincterotome	20	4.4 / 1.47	5	.025/450 Jagwire Guidewire	box 1
M00583100	TRUetome 44 Sphincterotome	20	4.4 / 1.47	5	.035/450 Jagwire Guidewire	box 1
M00583110	TRUetome 44 Sphincterotome	20	4.4 / 1.47	5	.035/450 Jagwire Guidewire	box 1
M00583120	TRUetome 39 Sphincterotome	30	3.9 / 1.30	5	.025/450 Jagwire Guidewire	box 1
M00583130	TRUetome 44 Sphincterotome	30	4.4 / 1.47	5	.025/450 Jagwire Guidewire	box 1
M00583140	TRUetome 44 Sphincterotome	30	4.4 / 1.47	5	.035/450 Jagwire Guidewire	box 1
M00583150	TRUetome 44 Sphincterotome	30	4.4 / 1.47	5	.035/450 Jagwire Guidewire	box 1

NEW TRUetome™ Dreamwire Cannulating Sphincterotomes with Pre-loaded Dreamwire™ Guidewire



Order Number	Description	Cut Wire (mm)	Tip O.D. (F) / (mm)	Tip Length (mm)	Pre-loaded Guidewire (in/cm)	Units
M00583190	TRUetome 44 Sphincterotome	20	4.4 / 1.47	5	.035/450 Dreamwire Guidewire	box 1
M00583210	TRUetome 44 Sphincterotome	30	4.4 / 1.47	5	.035/450 Dreamwire Guidewire	box 1

NEW TRUetome™ Hydra Cannulating Sphincterotomes with Pre-loaded Hydra Jagwire™ Guidewire



Order Number	Description	Cut Wire (mm)	Tip O.D. (F) / (mm)	Tip Length (mm)	Pre-loaded Guidewire (in/cm)	Units
M00583160	TRUetome 44 Sphincterotome	20	4.4 / 1.47	5	.035/450 Hydra Jagwire Guidewire	box 1
M00583170	TRUetome 44 Sphincterotome	30	4.4 / 1.47	5	.035/450 Hydra Jagwire Guidewire	box 1

Biliary

SPHINCTEROTOMES (CONTINUED)

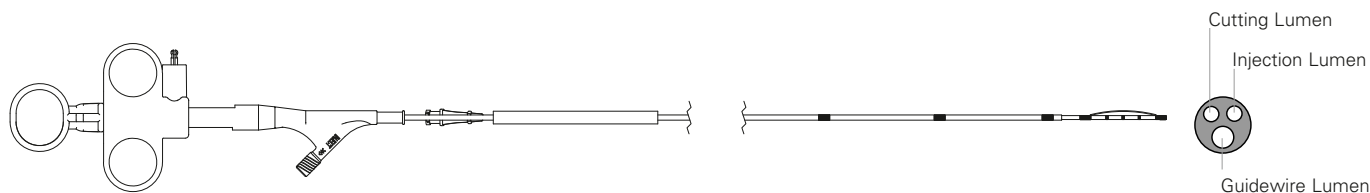

TRUEtome™ Cannulating Sphincterotomes



Order Number	Description	Cut Wire (mm)	Distal O.D. (F) / (mm)	Tip Length (mm)	Catheter Length (cm)	Units
M00584150	TRUEtome 49	20	4.9 / 1.63	5	200	box 1
M00584160	TRUEtome 49	30	4.9 / 1.63	5	200	box 1
M00584151	TRUEtome 49	20	4.9 / 1.63	5	200	box 10
M00584161	TRUEtome 49	30	4.9 / 1.63	5	200	box 10
M00584152	TRUEtome 49	20	4.9 / 1.63	5	200	box 20
M00584162	TRUEtome 49	30	4.9 / 1.63	5	200	box 20
M00584170	TRUEtome 44	20	4.4 / 1.47	5	200	box 1
M00584180	TRUEtome 44	30	4.4 / 1.47	5	200	box 1
M00584171	TRUEtome 44	20	4.4 / 1.47	5	200	box 10
M00584181	TRUEtome 44	30	4.4 / 1.47	5	200	box 10
M00584172	TRUEtome 44	20	4.4 / 1.47	5	200	box 20
M00584182	TRUEtome 44	30	4.4 / 1.47	5	200	box 20
M00584190	TRUEtome 39	20	3.9 / 1.30	5	200	box 1
M00584120	TRUEtome 39	30	3.9 / 1.30	5	200	box 1
M00584191	TRUEtome 39	20	3.9 / 1.30	5	200	box 10
M00584121	TRUEtome 39	30	3.9 / 1.30	5	200	box 10
M00584192	TRUEtome 39	20	3.9 / 1.30	5	200	box 20
M00584122	TRUEtome 39	30	3.9 / 1.30	5	200	box 20

Recommended Guidewire: .018 - .025in (0.46 - 0.64mm) for TRUEtome 39; .018 - .035in (0.46 - 0.89mm) for TRUEtome 44 and 49

Biliary

SPHINCTEROTOMES (CONTINUED)

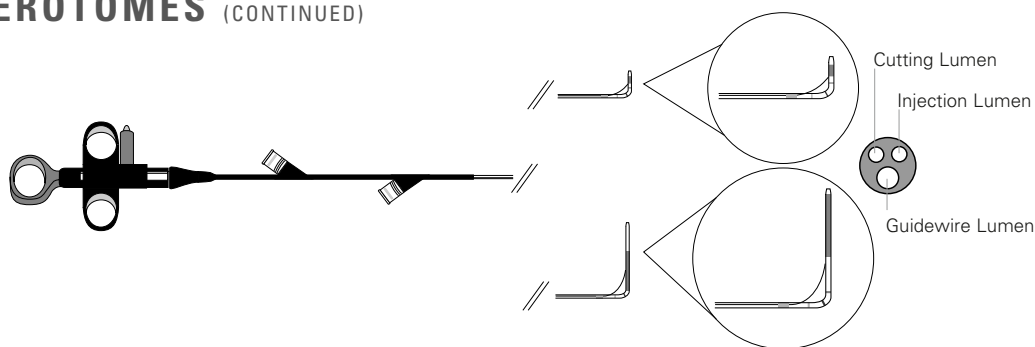

Ultratome XL™ Triple-lumen Wire-guided Sphincterotomes



Order Number	Description	Cut Wire (mm)	Distal O.D. (F) / (mm)	Tip Length (mm)	Catheter Length (cm)
M00535900	Ultratome XL Short Nose	20	5.5 / 1.83	5	200
M00535910	Ultratome XL Long Nose	20	5.5 / 1.83	20	200
M00535920	Ultratome XL Short Nose	30	5.5 / 1.83	5	200
M00535930	Ultratome XL Long Nose	30	5.5 / 1.83	20	200

Packaged one per box

Recommended Guidewire: .035in (0.89mm) Dreamwire™ High Performance Guidewire

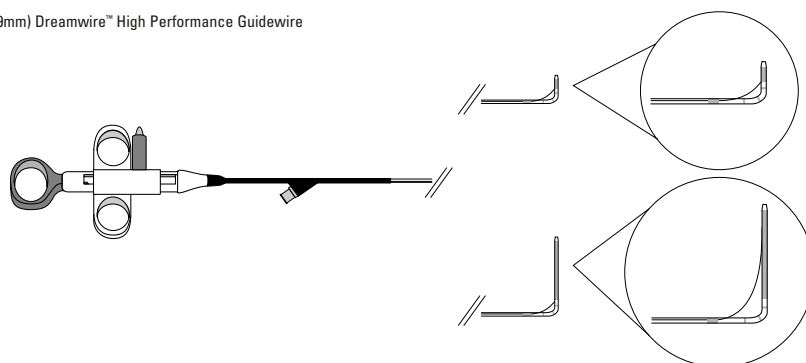

Ultratome™ Double-lumen Wire-guided Sphincterotomes



Order Number	Description	Cut Wire (mm)	Distal O.D. (F) / (mm)	Tip Length (mm)	Catheter Length (cm)
M00530800	Ultratome Short Nose	20	5.5 / 1.83	5	200
M00530810	Ultratome Long Nose	20	5.5 / 1.83	20	200
M00530820	Ultratome Short Nose	30	5.5 / 1.83	5	200
M00530830	Ultratome Long Nose	30	5.5 / 1.83	20	200

Packaged one per box

Recommended Guidewire: .035in (0.89mm) Dreamwire™ High Performance Guidewire

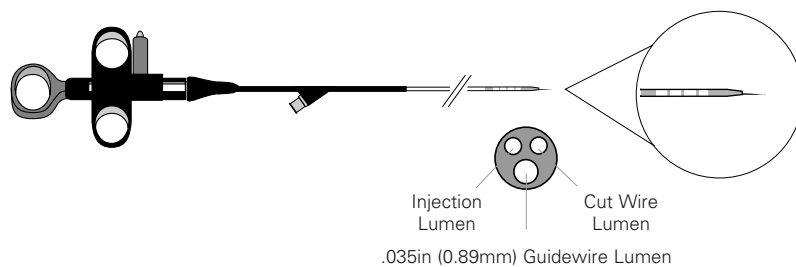

Microknife™ XL Triple-lumen Needleknife



Order Number	Description	Shaft O.D. (F) / (mm)	Catheter Length (cm)
M00532810	Microknife XL Triple-lumen Needleknife	7-5 / 2.33-1.83	200

Packaged one per box

Recommended Guidewire: .035in (0.89mm) Dreamwire™ High Performance Guidewire

Biliary

STONE RETRIEVAL

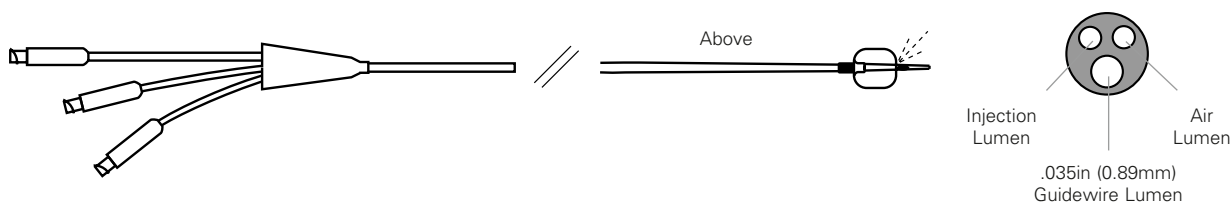

Extractor™ Pro XL Triple-lumen Retrieval Balloons – Distal Injection

Order Number	Description	Balloon O.D. (mm)	Injection	Catheter O.D. (F) / (mm)	System Length (cm)
M00547100	Extractor Pro XL Triple-lumen Retrieval Balloon	9.0-12.0	Above	7-6 / 2.33-2.00	200
M00547110	Extractor Pro XL Triple-lumen Retrieval Balloon	12.0-15.0	Above	7-6 / 2.33-2.00	200
M00547120	Extractor Pro XL Triple-lumen Retrieval Balloon	15.0-18.0	Above	7-6 / 2.33-2.00	200

Packaged one per box

Recommended Guidewire: .035in (0.89mm) Dreamwire™ High Performance Guidewire

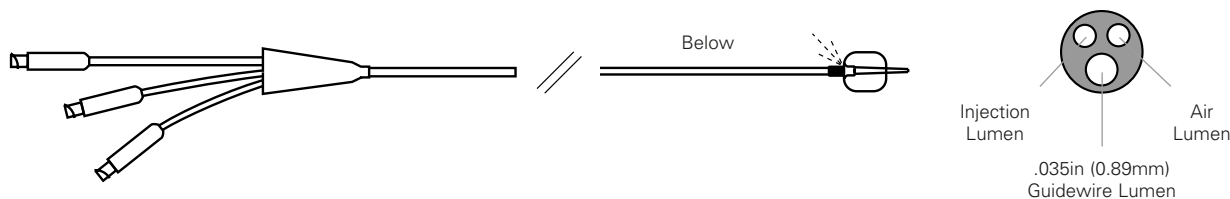

Extractor™ Pro XL Triple-lumen Retrieval Balloons – Proximal Injection

Order Number	Description	Balloon O.D. (mm)	Injection	Catheter O.D. (F) / (mm)	System Length (cm)
M00547130	Extractor Pro XL Triple-lumen Retrieval Balloon	9.0-12.0	Below	7-6 / 2.33-2.00	200
M00547140	Extractor Pro XL Triple-lumen Retrieval Balloon	12.0-15.0	Below	7-6 / 2.33-2.00	200
M00547150	Extractor Pro XL Triple-lumen Retrieval Balloon	15.0-18.0	Below	7-6 / 2.33-2.00	200

Packaged one per box

Recommended Guidewire: .035in (0.89mm) Dreamwire™ High Performance Guidewire

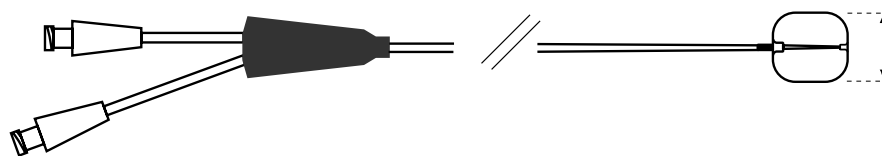

Extractor™ Pro DL Double-lumen Retrieval Balloons

Order Number	Description	Balloon O.D. (mm)	Injection	Catheter O.D. (F) / (mm)	System Length (cm)
M00547200	Extractor Pro DL Double-lumen Retrieval Balloon	9.0-12.0	N/A	7-6 / 2.33-2.00	200
M00547210	Extractor Pro DL Double-lumen Retrieval Balloon	12.0-15.0	N/A	7-6 / 2.33-2.00	200
M00547220	Extractor Pro DL Double-lumen Retrieval Balloon	15.0-18.0	N/A	7-6 / 2.33-2.00	200

Packaged one per box

Recommended Guidewire: .035in (0.89mm) Dreamwire™ High Performance Guidewire

Biliary

DILATION

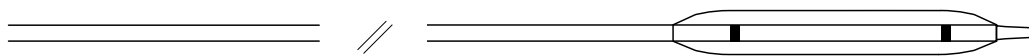

Max Force™ Biliary Dilation Balloons

Order Number	Description	Inflated O.D. (mm)	Balloon Length (cm)	Catheter Size (F) / (mm)	Required Working Channel (mm)
M00567330	Max Force Dilation Balloon	4	2	5 / 1.67	2.8
M00567340	Max Force Dilation Balloon	4	4	5 / 1.67	2.8
M00567370	Max Force Dilation Balloon	6	2	5 / 1.67	2.8
M00567380	Max Force Dilation Balloon	6	4	5 / 1.67	2.8
M00567410	Max Force Dilation Balloon	8	2	5 / 1.67	2.8
M00567420	Max Force Dilation Balloon	8	3	5 / 1.67	2.8

Packaged one per box

Recommended Guidewire: .035in (0.89mm) Dreamwire™ High Performance Guidewire

Recommended Inflation Device: Encore™ 26 Inflation Device, M00566670

ACCESSORIES

Accessories

Order Number	Description	Units
M00561250	Active Cord, Fits Olympus Brand Generator	box 1
M00561270	Active Cord, Fits Bovie®, Endostat™, Endostat II, Valleylab, Aspen Labs, ERBE Brand Generators	box 1
M00566670	⊗ Encore 26 Inflation Device	box 1
M00566001	⊗ Rapid Refill Continuous Injection System	box 10

Biliary Metal and Plastic Stents are located in the Stents Section on pages 26 and 31 – 32

Biliary Guidewires are located in the Guidewires Section on page 52

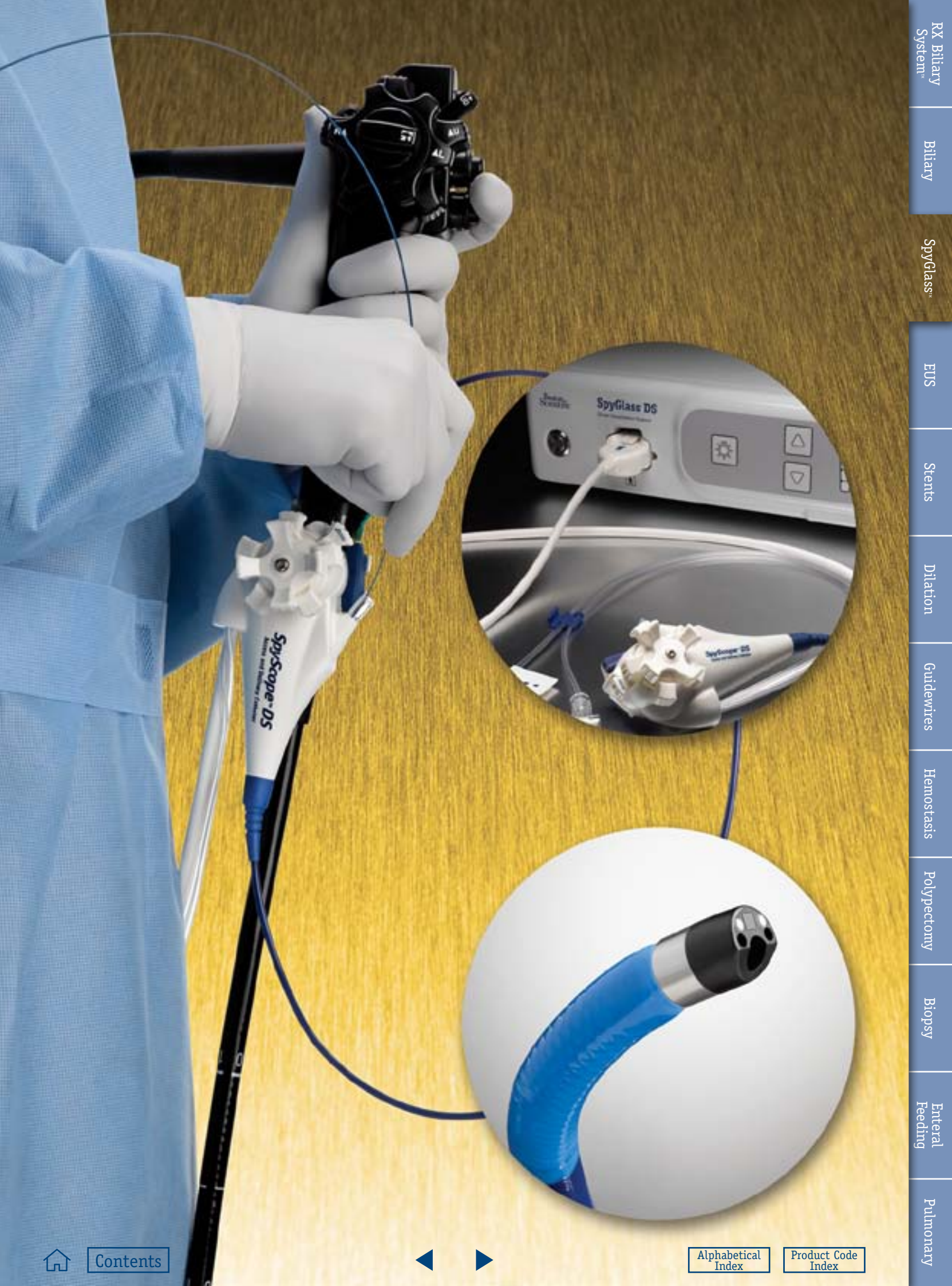

SpyGlass™ Direct Visualisation Systems

NEW SPYGLASS™ DS

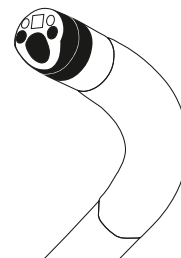
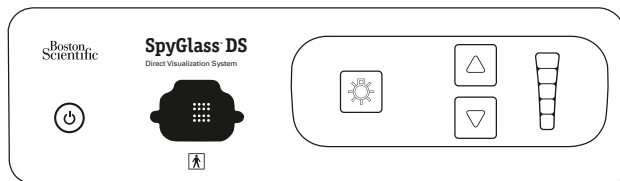

SpyGlass™ DS Capital Equipment

Order Number	Description	Units
M00546650	SpyGlass DS Digital Controller	box 1

SpyGlass™ DS Disposable Equipment



Order Number	Description	Units
M00546600	SpyScope™ DS Access and Delivery Catheter	box 1
M00546270	SpyBite™ Biopsy Forceps	box 1
M00546451	SpyGlass Irrigation Tube Set	box 10

SpyGlass™ Direct Visualisation Systems

SPYGLASS™

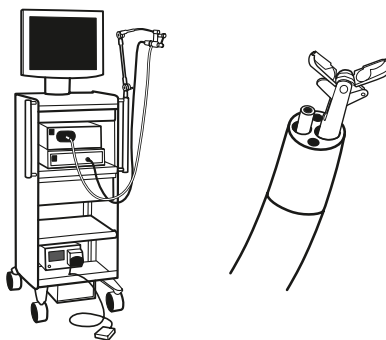

SpyGlass™ Capital Equipment

Order Number	Description	Units
M00546110	SpyGlass Camera PAL*	box 1
M00546120	SpyGlass Video Monitor	box 1
M00546160	SpyGlass Travel Cart ¹	box 1
M00546190	SpyGlass Lightsource	box 1
M00546210	SpyGlass Light Cable	box 1
M00546040	SpyGlass Ocular	box 1
M00546240	Isolation Transformer 230 V**	box 1
M00546140	Irrigation Pump with Foot Switch	box 1
M00546060	SpyGlass Storage Tray – Large ²	box 1
M00546050	SpyGlass Storage Tray – Small ²	box 1
M00546250	Power Cable Pack	box 1

- 3-Joint Arm (without clamp) is included with the Travel Cart (M00546160). The 3-Joint Arm with Clamp (M00546070) is useful if the account does not want to purchase the Travel Cart as it allows the account to mount the arm to another cart or table.
 - Purchase a minimum of two storage trays. Large storage trays are recommended unless they are to be reprocessed in an Olympus® Medivator Machine, into which the large storage trays will not fit. In this case, two small storage trays (M00546050) should be ordered.
- * For countries providing mains voltage of 120V please order M00546100 Spyglass Camera NTSC.
 ** For countries providing mains voltage of 120V please order M00546260 Isolation Transformer 120V.

SpyGlass™ Reusable Equipment

Order Number	Description	Units
M00546030	SpyGlass Direct Visualisation Probe ¹	box 1

- SpyGlass Probes have been validated to 20 cycles of reprocessing without degradation of image. The true number of procedural uses, however, will depend on how the SpyGlass Probe is handled. Fiberoptics are very sensitive and need delicate handling.

SpyGlass™ Disposable Equipment



Order Number	Description	Units
M00546230	SpyScope™ Access and Delivery Catheter	box 1
M00546270	SpyBite™ Biopsy Forceps	box 1
M00546451	SpyGlass Irrigation Tube Set	box 10

SpyGlass™ Optional Accessories

Order Number	Description	Units
M00546070	3-Joint Arm with Clamp ¹	box 1
M00546200	SpyGlass Light Source Replacement Bulb	box 1

- 3-Joint Arm (without clamp) is included with the Travel Cart (M00546160). The 3-Joint Arm with Clamp (M00546070) is useful if the account does not want to purchase the Travel Cart as it allows the account to mount the arm to another cart or table.



Endoscopic Ultrasound (EUS)

FINE NEEDLE ASPIRATION (FNA)

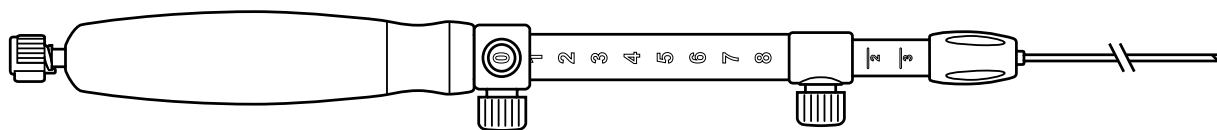

Expect™ Standard Handle Needles*



Order Number	Description	Needle Size (gauge) / (mm)	Minimum Working Channel (mm)	Sheath Diameter (mm)	Units
M00550000	Expect Standard Handle Needle	19 / 1.10	2.8	1.83	box 1
M00550001	Expect Standard Handle Needle	19 / 1.10	2.8	1.83	box 5
M00550040	Expect Standard Handle Needle	19 Flex / 1.14	2.8	1.73	box 1
M00550041	Expect Standard Handle Needle	19 Flex / 1.14	2.8	1.73	box 5
M00550010	Expect Standard Handle Needle	22 / 0.72	2.4	1.65	box 1
M00550011	Expect Standard Handle Needle	22 / 0.72	2.4	1.65	box 5
M00550020	Expect Standard Handle Needle	25 / 0.52	2.4	1.52	box 1
M00550021	Expect Standard Handle Needle	25 / 0.52	2.4	1.52	box 5

* Includes a 20cc syringe and one-way stopcock.
Working length: 137.5cm to 141.5cm, adjustable.
Needle length: 0cm to 8cm, adjustable.



Expect™ Slimline Handle Needles*



Order Number	Description	Needle Size (gauge) / (mm)	Minimum Working Channel (mm)	Sheath Diameter (mm)	Units
M00555500	Expect Slimline Handle Needle	19 / 1.10	2.8	1.83	box 1
M00555501	Expect Slimline Handle Needle	19 / 1.10	2.8	1.83	box 5
M00555530	Expect Slimline Handle Needle	19 Flex / 1.14	2.8	1.73	box 1
M00555531	Expect Slimline Handle Needle	19 Flex / 1.14	2.8	1.73	box 5
M00555510	Expect Slimline Handle Needle	22 / 0.72	2.4	1.65	box 1
M00555511	Expect Slimline Handle Needle	22 / 0.72	2.4	1.65	box 5
M00555520	Expect Slimline Handle Needle	25 / 0.52	2.4	1.52	box 1
M00555521	Expect Slimline Handle Needle	25 / 0.52	2.4	1.52	box 5

* Includes a 20cc syringe and one-way stopcock.
Working length: 137.5cm to 141.5cm, adjustable.
Needle length: 0cm to 8cm, adjustable.



Stents

RX BILIARY METAL STENTS



WallFlex™ Biliary RX Fully Covered Stents with Permalume™ Covering (including benign indication)



Order Number	Description	Diameter (mm)	Length (mm)	Catheter Diameter (F) / (mm)	Guidewire Diameter (in) / (mm)
M00570450†	WallFlex RX Biliary w/Permalume	8	60	8.5 / 2.83	.035 / 0.89
M00570460†	WallFlex RX Biliary w/Permalume	8	80	8.5 / 2.83	.035 / 0.89
M00576800†	WallFlex RX Biliary w/Permalume	8	100	9.0 / 3.00	.035 / 0.89
M00576810†	WallFlex RX Biliary w/Permalume	8	120	9.0 / 3.00	.035 / 0.89
M00570470†	WallFlex RX Biliary w/Permalume	10	40	8.5 / 2.83	.035 / 0.89
M00570480†	WallFlex RX Biliary w/Permalume	10	60	8.5 / 2.83	.035 / 0.89
M00570490†	WallFlex RX Biliary w/Permalume	10	80	8.5 / 2.83	.035 / 0.89
M00576820†	WallFlex RX Biliary w/Permalume	10	100	9.0 / 3.00	.035 / 0.89
M00576830†	WallFlex RX Biliary w/Permalume	10	120	9.0 / 3.00	.035 / 0.89

† Product commercialised only in countries where benign indication is approved.



WallFlex™ Biliary RX Partially Covered Stents with Permalume™ Covering

Order Number	Description	Diameter (mm)	Length (mm)	Covered Length (mm)	Catheter Diameter (F) / (mm)	Guidewire Diameter (in) / (mm)
M00570700	WallFlex RX Biliary w/Permalume	8	60	48	8.5 / 2.83	.035 / 0.89
M00570710	WallFlex RX Biliary w/Permalume	8	80	68	8.5 / 2.83	.035 / 0.89
M00576740	WallFlex RX Biliary w/Permalume	8	100	88	9.0 / 3.00	.035 / 0.89
M00576750	WallFlex RX Biliary w/Permalume	8	120	108	9.0 / 3.00	.035 / 0.89
M00570720	WallFlex RX Biliary w/Permalume	10	40	28	8.5 / 2.83	.035 / 0.89
M00570730	WallFlex RX Biliary w/Permalume	10	60	48	8.5 / 2.83	.035 / 0.89
M00570740	WallFlex RX Biliary w/Permalume	10	80	68	8.5 / 2.83	.035 / 0.89
M00576760	WallFlex RX Biliary w/Permalume	10	100	88	9.0 / 3.00	.035 / 0.89
M00576770	WallFlex RX Biliary w/Permalume	10	120	108	9.0 / 3.00	.035 / 0.89

Packaged one per box

Recommended Guidewire: .035in (0.89mm) Dreamwire™ High Performance Guidewire Stiff Shaft, 260cm or .035in (0.89mm) Dreamwire™ High Performance Guidewire, 260cm

Stents

RX BILIARY METAL STENTS (CONTINUED)



WallFlex™ Biliary RX Non-covered Stents

Order Number	Description	Diameter (mm)	Length (mm)	Catheter Diameter (F) / (mm)	Guidewire Diameter (in) / (mm)
M00570600	WallFlex RX Biliary	8	40	8 / 2.67	.035 / 0.89
M00570610	WallFlex RX Biliary	8	60	8 / 2.67	.035 / 0.89
M00570620	WallFlex RX Biliary	8	80	8 / 2.67	.035 / 0.89
M00570630	WallFlex RX Biliary	8	100	8 / 2.67	.035 / 0.89
M00576780	WallFlex RX Biliary	8	120	8 / 2.67	.035 / 0.89
M00570890	WallFlex RX Biliary	10	40	8 / 2.67	.035 / 0.89
M00570640	WallFlex RX Biliary	10	60	8 / 2.67	.035 / 0.89
M00570650	WallFlex RX Biliary	10	80	8 / 2.67	.035 / 0.89
M00570660	WallFlex RX Biliary	10	100	8 / 2.67	.035 / 0.89
M00576790	WallFlex RX Biliary	10	120	8 / 2.67	.035 / 0.89

Packaged one per box

Recommended Guidewire: .035in (0.89mm) Dreamwire™ High Performance Guidewire Stiff Shaft, 260cm or .035in (0.89mm) Dreamwire™ High Performance Guidewire, 260cm

Stents

RX BILIARY METAL STENTS (CONTINUED)

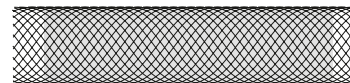
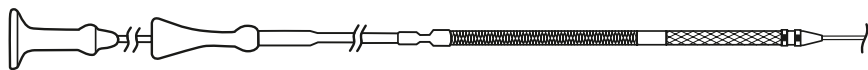

Wallstent™ RX Biliary Stents with Permalume™ Covering



Order Number	Description	Covered Length (mm)	Unconstrained Diameter (mm)	Nominal Unconstrained Length (mm)	Delivery System (F) / (mm)	Working Length (cm)
M00569670	Wallstent RX w/Permalume	30	8	40	8 / 2.67	194
M00569680	Wallstent RX w/Permalume	50	8	60	8 / 2.67	194
M00569690	Wallstent RX w/Permalume	70	8	80	8 / 2.67	194
M00569700	Wallstent RX w/Permalume	30	10	40	8 / 2.67	194
M00569710	Wallstent RX w/Permalume	50	10	60	8 / 2.67	194
M00569720	Wallstent RX w/Permalume	70	10	80	8 / 2.67	194

Packaged one per box

Recommended Guidewires: .035in (0.89mm) Dreamwire™ High Performance Guidewire Stiff Shaft, 260cm or .035in (0.89mm) Dreamwire™ High Performance Guidewire, 260cm

Wallstent™ RX Biliary Stents



Order Number	Description	Unconstrained Diameter (mm)	Nominal Unconstrained Length (mm)	Delivery System (F) / (mm)	Working Length (cm)
M00569610	Wallstent RX Biliary	8	40	8 / 2.67	194
M00569620	Wallstent RX Biliary	8	60	8 / 2.67	194
M00569630	Wallstent RX Biliary	8	80	8 / 2.67	194
M00569800	Wallstent RX Biliary	8	100	8 / 2.67	194
M00569640	Wallstent RX Biliary	10	40	8 / 2.67	194
M00569650	Wallstent RX Biliary	10	60	8 / 2.67	194
M00569660	Wallstent RX Biliary	10	80	8 / 2.67	194
M00569810	Wallstent RX Biliary	10	100	8 / 2.67	194

Packaged one per box

Recommended Guidewires: .035in (0.89mm) Dreamwire™ High Performance Guidewire Stiff Shaft, 260cm or .035in (0.89mm) Dreamwire™ High Performance Guidewire, 260cm

Stents

BILIARY METAL STENTS

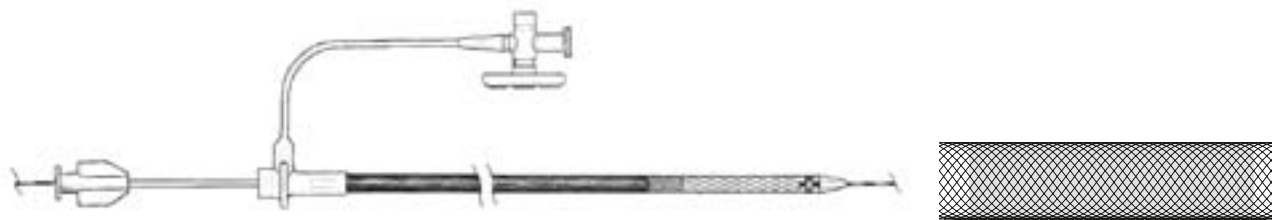

Wallstent™ Biliary Stents with Permalume™ Covering



Order Number	Description	Covered Length (mm)	Unconstrained Diameter (mm)	Nominal Unconstrained Length (mm)	Delivery System (F) / (mm)	Working Length (cm)
H965430700	Wallstent Biliary with Permalume	30	8	40	8 / 2.67	194
H965430800	Wallstent Biliary with Permalume	50	8	60	8 / 2.67	194
H965430900	Wallstent Biliary with Permalume	70	8	80	8 / 2.67	194
H965431000	Wallstent Biliary with Permalume	30	10	40	8 / 2.67	194
H965431100	Wallstent Biliary with Permalume	50	10	60	8 / 2.67	194
H965431200	Wallstent Biliary with Permalume	70	10	80	8 / 2.67	194

Packaged one per box

Recommended Guidewires: .035in (0.89mm) Dreamwire™ High Performance Guidewire Stiff Shaft or .035in (0.89mm) Dreamwire™ High Performance Guidewire

Wallstent™ Biliary Stents



Order Number	Description	Unconstrained Diameter (mm)	Nominal Unconstrained Length (mm)	Delivery System (F) / (mm)	Working Length (cm)
H965430100	Wallstent Biliary	8	40	7.5 / 2.5	194
H965430200	Wallstent Biliary	8	60	7.5 / 2.5	194
H965430300	Wallstent Biliary	8	80	7.5 / 2.5	194
H965430400	Wallstent Biliary	10	40	7.5 / 2.5	194
H965430500	Wallstent Biliary	10	60	7.5 / 2.5	194
H965430600	Wallstent Biliary	10	80	7.5 / 2.5	194

Packaged one per box

Recommended Guidewires: .035in (0.89mm) Dreamwire™ High Performance Guidewire Stiff Shaft or .035in (0.89mm) Dreamwire™ High Performance Guidewire

Stents

RX BILIARY PLASTIC STENTS

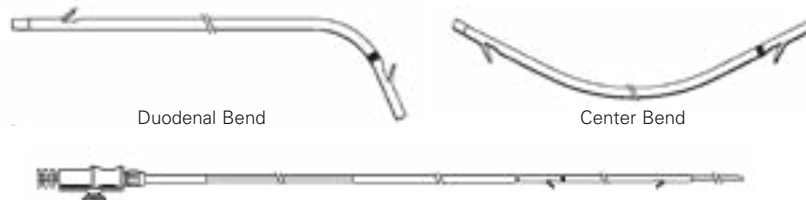

Advanix™ Pre-loaded RX Stents with NaviFlex™ RX Delivery System



Order Number	Description	Shape	O.D. (F) / (mm)	Length (cm) Barb to Barb
M00534200	Advanix Pre-loaded RX Stent	Duodenal Bend	7 / 2.3	5
M00534210	Advanix Pre-loaded RX Stent	Duodenal Bend	7 / 2.3	7
M00534220	Advanix Pre-loaded RX Stent	Duodenal Bend	7 / 2.3	9
M00534230	Advanix Pre-loaded RX Stent	Duodenal Bend	7 / 2.3	12
M00534240	Advanix Pre-loaded RX Stent	Duodenal Bend	7 / 2.3	15
M00534250	Advanix Pre-loaded RX Stent	Duodenal Bend	7 / 2.3	18
M00534260	Advanix Pre-loaded RX Stent	Duodenal Bend	8.5 / 2.83	5
M00534270	Advanix Pre-loaded RX Stent	Duodenal Bend	8.5 / 2.83	7
M00534280	Advanix Pre-loaded RX Stent	Duodenal Bend	8.5 / 2.83	9
M00534290	Advanix Pre-loaded RX Stent	Duodenal Bend	8.5 / 2.83	12
M00534300	Advanix Pre-loaded RX Stent	Duodenal Bend	8.5 / 2.83	15
M00534310	Advanix Pre-loaded RX Stent	Duodenal Bend	8.5 / 2.83	18
M00534320	Advanix Pre-loaded RX Stent	Duodenal Bend	10 / 3.3	5
M00534330	Advanix Pre-loaded RX Stent	Duodenal Bend	10 / 3.3	7
M00534340	Advanix Pre-loaded RX Stent	Duodenal Bend	10 / 3.3	9
M00534350	Advanix Pre-loaded RX Stent	Duodenal Bend	10 / 3.3	12
M00534360	Advanix Pre-loaded RX Stent	Duodenal Bend	10 / 3.3	15
M00534370	Advanix Pre-loaded RX Stent	Duodenal Bend	10 / 3.3	18
M00534560	Advanix Pre-loaded RX Stent	Center Bend	7 / 2.3	5
M00534570	Advanix Pre-loaded RX Stent	Center Bend	7 / 2.3	7
M00534580	Advanix Pre-loaded RX Stent	Center Bend	7 / 2.3	9
M00534590	Advanix Pre-loaded RX Stent	Center Bend	7 / 2.3	12
M00534600	Advanix Pre-loaded RX Stent	Center Bend	7 / 2.3	15
M00534610	Advanix Pre-loaded RX Stent	Center Bend	7 / 2.3	18
M00534620	Advanix Pre-loaded RX Stent	Center Bend	8.5 / 2.83	5
M00534630	Advanix Pre-loaded RX Stent	Center Bend	8.5 / 2.83	7
M00534640	Advanix Pre-loaded RX Stent	Center Bend	8.5 / 2.83	9
M00534650	Advanix Pre-loaded RX Stent	Center Bend	8.5 / 2.83	12
M00534660	Advanix Pre-loaded RX Stent	Center Bend	8.5 / 2.83	15
M00534670	Advanix Pre-loaded RX Stent	Center Bend	8.5 / 2.83	18
M00534680	Advanix Pre-loaded RX Stent	Center Bend	10 / 3.3	5
M00534690	Advanix Pre-loaded RX Stent	Center Bend	10 / 3.3	7
M00534700	Advanix Pre-loaded RX Stent	Center Bend	10 / 3.3	9
M00534710	Advanix Pre-loaded RX Stent	Center Bend	10 / 3.3	12
M00534720	Advanix Pre-loaded RX Stent	Center Bend	10 / 3.3	15
M00534730	Advanix Pre-loaded RX Stent	Center Bend	10 / 3.3	18

Packaged one per box

Recommended Guidewire: .035in (0.89mm) Dreamwire™ High Performance Guidewire

Scope Compatibility: 7F (2.3mm) and 8.5F (2.83mm) stents require a 3.2mm working channel; 10F (3.3mm) stents require a 4.2mm working channel



Contents

Alphabetical Index

Product Code Index

Stents

RX BILIARY PLASTIC STENTS (CONTINUED)



Duodenal Bend



Center Bend



Double Pigtail



Advanix™ Stents – Singles

Order Number	Description	Shape	O.D. (F)/(mm)	Length (cm) Barb to Barb
M00532870	Advanix Stent	Duodenal Bend	7 / 2.3	5
M00532880	Advanix Stent	Duodenal Bend	7 / 2.3	7
M00532890	Advanix Stent	Duodenal Bend	7 / 2.3	9
M00532900	Advanix Stent	Duodenal Bend	7 / 2.3	12
M00532910	Advanix Stent	Duodenal Bend	7 / 2.3	15
M00532920	Advanix Stent	Duodenal Bend	7 / 2.3	18
M00532930	Advanix Stent	Duodenal Bend	8.5 / 2.83	5
M00532940	Advanix Stent	Duodenal Bend	8.5 / 2.83	7
M00532950	Advanix Stent	Duodenal Bend	8.5 / 2.83	9
M00532960	Advanix Stent	Duodenal Bend	8.5 / 2.83	12
M00532970	Advanix Stent	Duodenal Bend	8.5 / 2.83	15
M00532980	Advanix Stent	Duodenal Bend	8.5 / 2.83	18
M00532990	Advanix Stent	Duodenal Bend	10 / 3.3	5
M00533000	Advanix Stent	Duodenal Bend	10 / 3.3	7
M00533010	Advanix Stent	Duodenal Bend	10 / 3.3	9
M00533020	Advanix Stent	Duodenal Bend	10 / 3.3	12
M00533030	Advanix Stent	Duodenal Bend	10 / 3.3	15
M00533040	Advanix Stent	Duodenal Bend	10 / 3.3	18
M00533230	Advanix Stent	Center Bend	7 / 2.3	5
M00533240	Advanix Stent	Center Bend	7 / 2.3	7
M00533250	Advanix Stent	Center Bend	7 / 2.3	9
M00533260	Advanix Stent	Center Bend	7 / 2.3	12
M00533270	Advanix Stent	Center Bend	7 / 2.3	15
M00533280	Advanix Stent	Center Bend	7 / 2.3	18
M00533290	Advanix Stent	Center Bend	8.5 / 2.83	5
M00533300	Advanix Stent	Center Bend	8.5 / 2.83	7
M00533310	Advanix Stent	Center Bend	8.5 / 2.83	9
M00533320	Advanix Stent	Center Bend	8.5 / 2.83	12
M00533330	Advanix Stent	Center Bend	8.5 / 2.83	15
M00533340	Advanix Stent	Center Bend	8.5 / 2.83	18
M00533350	Advanix Stent	Center Bend	10 / 3.3	5
M00533360	Advanix Stent	Center Bend	10 / 3.3	7
M00533370	Advanix Stent	Center Bend	10 / 3.3	9
M00533380	Advanix Stent	Center Bend	10 / 3.3	12
M00533390	Advanix Stent	Center Bend	10 / 3.3	15
M00533400	Advanix Stent	Center Bend	10 / 3.3	18

Stents

RX BILIARY PLASTIC STENTS (CONTINUED)

Advanix™ Stents – Singles (CONTINUED)



Order Number	Description	Shape	O.D. (F) / (mm)	Length (cm) Between Pigtails
M00532160	Advanix Stent	Double Pigtail	7 / 2.3	3
M00532180	Advanix Stent	Double Pigtail	7 / 2.3	5
M00532190	Advanix Stent	Double Pigtail	7 / 2.3	7
M00532210	Advanix Stent	Double Pigtail	7 / 2.3	10
M00532220	Advanix Stent	Double Pigtail	7 / 2.3	12
M00532230	Advanix Stent	Double Pigtail	7 / 2.3	15
M00532240	Advanix Stent	Double Pigtail	10 / 3.3	3
M00532260	Advanix Stent	Double Pigtail	10 / 3.3	5
M00532270	Advanix Stent	Double Pigtail	10 / 3.3	7
M00532290	Advanix Stent	Double Pigtail	10 / 3.3	10
M00532300	Advanix Stent	Double Pigtail	10 / 3.3	12
M00532310	Advanix Stent	Double Pigtail	10 / 3.3	15

Packaged one per box

Recommended Guidewire: .035in (0.89mm) Dreamwire™ High Performance Guidewire

Scope Compatibility: 7F (2.3mm) and 8.5F (2.83mm) stents require a 3.2mm working channel; 10F (3.3mm) stents require a 4.2mm working channel



NaviFlex™ RX Delivery System



Order Number	Description	Catheter Diameter (mm)	Working Length (cm)
M00533560	RX Delivery System	7 / 2.3	202.5
M00533570	RX Delivery System	8.5 / 2.83	202.5
M00533580	RX Delivery System	10 / 3.3	202.5

Packaged one per box

Stents

RX BILIARY PLASTIC STENTS (CONTINUED)



RX Biliary Plastic Stents

Order Number	Description	O.D. (F) / (mm)	Length (cm) Barb to Barb
M00545550	RX Biliary Plastic Stent	7 / 2.33	5
M00545560	RX Biliary Plastic Stent	7 / 2.33	7
M00545570	RX Biliary Plastic Stent	7 / 2.33	10
M00545580	RX Biliary Plastic Stent	7 / 2.33	12
M00545590	RX Biliary Plastic Stent	7 / 2.33	15
M00545650	RX Biliary Plastic Stent	8.5 / 2.83	5
M00545660	RX Biliary Plastic Stent	8.5 / 2.83	7
M00545670	RX Biliary Plastic Stent	8.5 / 2.83	10
M00545680	RX Biliary Plastic Stent	8.5 / 2.83	12
M00545690	RX Biliary Plastic Stent	8.5 / 2.83	15
M00545600	RX Biliary Plastic Stent	10 / 3.33	5
M00545610	RX Biliary Plastic Stent	10 / 3.33	7
M00545620	RX Biliary Plastic Stent	10 / 3.33	10
M00545630	RX Biliary Plastic Stent	10 / 3.33	12
M00545640	RX Biliary Plastic Stent	10 / 3.33	15
M00545700	RX Biliary Plastic Stent	11.5 / 3.83	5
M00545710	RX Biliary Plastic Stent	11.5 / 3.83	7
M00545720	RX Biliary Plastic Stent	11.5 / 3.83	10
M00545730	RX Biliary Plastic Stent	11.5 / 3.83	12
M00545740	RX Biliary Plastic Stent	11.5 / 3.83	15

Packaged one per box

Recommended Guidewire: .035in (0.89mm) Dreamwire™ High Performance Guidewire



Stents

BILIARY PLASTIC STENTS



Flexima™ Biliary Stents



Order Number	Description	O.D. (F) / (mm)	Length (cm) Barb to Barb
M00539200	Flexima Stent	7 / 2.33	5
M00539210	Flexima Stent	7 / 2.33	7
M00539220	Flexima Stent	7 / 2.33	10
M00539230	Flexima Stent	7 / 2.33	12
M00539240	Flexima Stent	7 / 2.33	15
M00539250	Flexima Stent	8.5 / 2.83	5
M00539260	Flexima Stent	8.5 / 2.83	7
M00539270	Flexima Stent	8.5 / 2.83	10
M00539280	Flexima Stent	8.5 / 2.83	12
M00539290	Flexima Stent	8.5 / 2.83	15
M00539300	Flexima Stent	10 / 3.33	5
M00539310	Flexima Stent	10 / 3.33	7
M00539320	Flexima Stent	10 / 3.33	10
M00539330	Flexima Stent	10 / 3.33	12
M00539340	Flexima Stent	10 / 3.33	15
M00539350	Flexima Stent	11.5 / 3.83	5
M00539360	Flexima Stent	11.5 / 3.83	7
M00539370	Flexima Stent	11.5 / 3.83	10
M00539380	Flexima Stent	11.5 / 3.83	12
M00539390	Flexima Stent	11.5 / 3.83	15

Packaged one per box

Recommended Guidewire: .035in (0.89mm) Dreamwire™ High Performance Guidewire

Flexima™ Nasobiliary Stents



Order Number	Description	O.D. (F) / (mm)	Catheter Length (cm)	Recommended Guidewire (in) / (mm)
M00540120†	Flexima Nasal Stent	6 / 2.00	250	.035 / 0.89
M00540130†	Flexima Nasal Stent	7.5 / 2.50	250	.035 / 0.89
M00540140†	Flexima Nasal Stent	8.5 / 2.83	250	.035 / 0.89
M00540160†	Flexima Nasal Stent	6 / 2.00	250	Steel Teflon® coated wire included*
M00540170†	Flexima Nasal Stent	7.5 / 2.50	250	Steel Teflon® coated wire included*
M00540180†	Flexima Nasal Stent	8.5 / 2.83	250	Steel Teflon® coated wire included*

Packaged one per box

Recommended Guidewire: .035in (0.89mm) Dreamwire™ High Performance Guidewire

† Product available in the European Economic Area (EEA) only. Please check availability of the product with your local sales representative or your local customer service.

* Teflon® is a registered trademark of E. I. DuPont Nemours & Co. Inc.



Stents

BILIARY PLASTIC STENTS (CONTINUED)



Percuflex™ Amsterdam Biliary Stents



Order Number	Description	O.D. (F) / (mm)	Length (cm) Barb to Barb
M00533610	Percuflex Amsterdam Stent	7 / 2.33	5
M00533620	Percuflex Amsterdam Stent	7 / 2.33	7
M00533630	Percuflex Amsterdam Stent	7 / 2.33	10
M00533640	Percuflex Amsterdam Stent	7 / 2.33	12
M00533650	Percuflex Amsterdam Stent	7 / 2.33	15
M00533660	Percuflex Amsterdam Stent	10 / 3.33	5
M00533670	Percuflex Amsterdam Stent	10 / 3.33	7
M00533680	Percuflex Amsterdam Stent	10 / 3.33	10
M00533690	Percuflex Amsterdam Stent	10 / 3.33	12
M00533700	Percuflex Amsterdam Stent	10 / 3.33	15

Packaged one per box

Recommended Guidewire: .035in (0.89mm) Dreamwire™ High Performance Guidewire

Percuflex™ Amsterdam Introducer Kits*



Order Number	Description
M00533910	Percuflex Amsterdam Stent Kit w/push catheter for use with 7F (2.33mm) O.D. stent
M00533920	Percuflex Amsterdam Stent Kit w/push and guide catheter for use with 10F (3.33mm) O.D. stent

Packaged one per box

Recommended Guidewire: .035in (0.89mm) Dreamwire™ High Performance Guidewire

* Stents sold separately.



C-flex™ Pigtail Biliary Stents*



Order Number	Description	O.D. (F) / (mm)	Length (cm) Barb to Barb	Colour Code
M00532010	C-flex Pigtail Stent	7 / 2.33	5	Blue
M00532020	C-flex Pigtail Stent	7 / 2.33	10	Blue
M00532030	C-flex Pigtail Stent	7 / 2.33	15	Blue
M00532040	C-flex Pigtail Stent	10 / 3.33	5	Grey
M00532050	C-flex Pigtail Stent	10 / 3.33	10	Grey
M00532060	C-flex Pigtail Stent	10 / 3.33	15	Grey

Packaged one per box

Recommended Guidewire: .035in (0.89mm) Dreamwire™ High Performance Guidewire

* For use with Percuflex™ Amsterdam Single-use Introducer Kit.

Stents

PANCREATIC PLASTIC STENTS

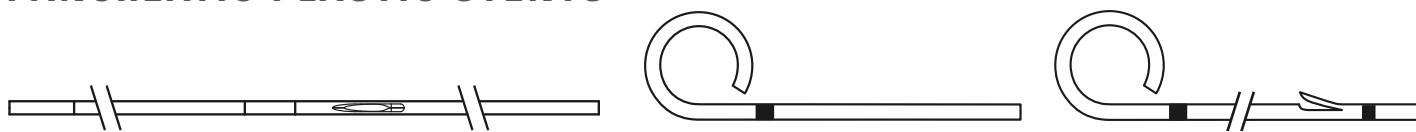

NEW Advanix™ Pancreatic Stent Kits (Stent + RX Pusher) – Pigtail



Order Number	Description	Leading Barb	Shape	O.D. (F) / (mm)	Length (cm)
M00537350	Advanix Pancreatic Stent Kit ●	No	Pigtail	4 / 1.35	3
M00537360	Advanix Pancreatic Stent Kit ▲	No	Pigtail	4 / 1.35	4
M00537370	Advanix Pancreatic Stent Kit ▲	No	Pigtail	4 / 1.35	5
M00537380	Advanix Pancreatic Stent Kit ▲	No	Pigtail	4 / 1.35	7
M00537390	Advanix Pancreatic Stent Kit ●	No	Pigtail	5 / 1.67	3
M00537400	Advanix Pancreatic Stent Kit ▲	No	Pigtail	5 / 1.67	4
M00537410	Advanix Pancreatic Stent Kit ▲	No	Pigtail	5 / 1.67	5
M00537420	Advanix Pancreatic Stent Kit ▲	No	Pigtail	5 / 1.67	7
M00537430	Advanix Pancreatic Stent Kit ●	Yes	Pigtail	5 / 1.67	3
M00537440	Advanix Pancreatic Stent Kit ▲	Yes	Pigtail	5 / 1.67	4
M00537450	Advanix Pancreatic Stent Kit ▲	Yes	Pigtail	5 / 1.67	5



NEW Advanix™ Pancreatic Stent Kits (Stent + RX Pusher) – Straight



Order Number	Description	Leading Barb	Shape	O.D. (F) / (mm)	Length (cm)
M00537460	Advanix Pancreatic Stent Kit ● ¹	No	Straight	4 / 1.35	3
M00537470	Advanix Pancreatic Stent Kit ▲ ¹	No	Straight	4 / 1.35	4
M00537480	Advanix Pancreatic Stent Kit ▲ ¹	No	Straight	4 / 1.35	5
M00537490	Advanix Pancreatic Stent Kit ▲ ¹	No	Straight	4 / 1.35	7
M00537500	Advanix Pancreatic Stent Kit ●	No	Straight	5 / 1.67	3
M00537510	Advanix Pancreatic Stent Kit ▲	No	Straight	5 / 1.67	4
M00537520	Advanix Pancreatic Stent Kit ▲	No	Straight	5 / 1.67	5
M00537530	Advanix Pancreatic Stent Kit ▲	No	Straight	5 / 1.67	7
M00537540	Advanix Pancreatic Stent Kit ●	Yes	Straight	5 / 1.67	3
M00537550	Advanix Pancreatic Stent Kit ▲	Yes	Straight	5 / 1.67	4
M00537560	Advanix Pancreatic Stent Kit ▲	Yes	Straight	5 / 1.67	5

■ Trailing endoscopic marker ● Trailing radiopaque marker ▲ Leading radiopaque marker with trailing endoscopic marker

¹ Stiffer stent material compared to 4F pigtail stents.

² Stiffer stent material compared to 5F pigtail and 5F straight stents with No Leading Barb.



Stents

PANCREATIC PLASTIC STENTS (CONTINUED)



NEW Advanix™ Pancreatic Single Stents – Pigtail

Order Number	Description	Leading Barb	Shape	O.D. (F) / (mm)	Length (cm)
M00536740	Advanix Pancreatic Stent ■	No	Pigtail	3 / 1.00	2
M00536750	Advanix Pancreatic Stent ■	No	Pigtail	3 / 1.00	3
M00536760	Advanix Pancreatic Stent ■	No	Pigtail	3 / 1.00	4
M00536770	Advanix Pancreatic Stent ■	No	Pigtail	3 / 1.00	5
M00536780	Advanix Pancreatic Stent ■	No	Pigtail	3 / 1.00	6
M00536790	Advanix Pancreatic Stent ■	No	Pigtail	3 / 1.00	7
M00536800	Advanix Pancreatic Stent ■	No	Pigtail	3 / 1.00	8
M00536810	Advanix Pancreatic Stent ■	No	Pigtail	3 / 1.00	9
M00536820	Advanix Pancreatic Stent ■	No	Pigtail	3 / 1.00	10
M00536830	Advanix Pancreatic Stent ■	No	Pigtail	3 / 1.00	11
M00536840	Advanix Pancreatic Stent ■	No	Pigtail	3 / 1.00	12
M00536850	Advanix Pancreatic Stent ■	No	Pigtail	3 / 1.00	13
M00536860	Advanix Pancreatic Stent ●	No	Pigtail	4 / 1.35	2
M00536870	Advanix Pancreatic Stent ●	No	Pigtail	4 / 1.35	3
M00536880	Advanix Pancreatic Stent ▲	No	Pigtail	4 / 1.35	4
M00536890	Advanix Pancreatic Stent ▲	No	Pigtail	4 / 1.35	5
M00536900	Advanix Pancreatic Stent ▲	No	Pigtail	4 / 1.35	6
M00536910	Advanix Pancreatic Stent ▲	No	Pigtail	4 / 1.35	7
M00536920	Advanix Pancreatic Stent ▲	No	Pigtail	4 / 1.35	8
M00536930	Advanix Pancreatic Stent ▲	No	Pigtail	4 / 1.35	9
M00536940	Advanix Pancreatic Stent ▲	No	Pigtail	4 / 1.35	10
M00536950	Advanix Pancreatic Stent ▲	No	Pigtail	4 / 1.35	11
M00536960	Advanix Pancreatic Stent ▲	No	Pigtail	4 / 1.35	12
M00536970	Advanix Pancreatic Stent ▲	No	Pigtail	4 / 1.35	13
M00536980	Advanix Pancreatic Stent ●	No	Pigtail	5 / 1.67	2
M00536990	Advanix Pancreatic Stent ●	No	Pigtail	5 / 1.67	3
M00537000	Advanix Pancreatic Stent ▲	No	Pigtail	5 / 1.67	4
M00537010	Advanix Pancreatic Stent ▲	No	Pigtail	5 / 1.67	5
M00537020	Advanix Pancreatic Stent ▲	No	Pigtail	5 / 1.67	6
M00537030	Advanix Pancreatic Stent ▲	No	Pigtail	5 / 1.67	7
M00537040	Advanix Pancreatic Stent ▲	No	Pigtail	5 / 1.67	8
M00537050	Advanix Pancreatic Stent ▲	No	Pigtail	5 / 1.67	9
M00537060	Advanix Pancreatic Stent ▲	No	Pigtail	5 / 1.67	10
M00537070	Advanix Pancreatic Stent ▲	No	Pigtail	5 / 1.67	11
M00537080	Advanix Pancreatic Stent ▲	No	Pigtail	5 / 1.67	12
M00537090	Advanix Pancreatic Stent ▲	No	Pigtail	5 / 1.67	13

■ Trailing endoscopic marker ● Trailing radiopaque marker ▲ Leading radiopaque marker with trailing endoscopic marker

1 Stiffer stent material compared to 4F pigtail stents.

2 Stiffer stent material compared to 5F pigtail and 5F straight stents with No Leading Barb.



Stents

PANCREATIC PLASTIC STENTS (CONTINUED)

NEW Advanix™ Pancreatic Single Stents – Pigtail (CONTINUED)



Order Number	Description	Leading Barb	Shape	O.D. (F) / (mm)	Length (cm)
M00537100	Advanix Pancreatic Stent ●	Yes	Pigtail	5 / 1.67	2
M00537110	Advanix Pancreatic Stent ●	Yes	Pigtail	5 / 1.67	3
M00537120	Advanix Pancreatic Stent ▲	Yes	Pigtail	5 / 1.67	4
M00537130	Advanix Pancreatic Stent ▲	Yes	Pigtail	5 / 1.67	5
M00537140	Advanix Pancreatic Stent ▲ ²	Yes	Pigtail	5 / 1.67	6
M00537150	Advanix Pancreatic Stent ▲ ²	Yes	Pigtail	5 / 1.67	7
M00537160	Advanix Pancreatic Stent ▲ ²	Yes	Pigtail	5 / 1.67	8
M00537170	Advanix Pancreatic Stent ▲ ²	Yes	Pigtail	5 / 1.67	9
M00537180	Advanix Pancreatic Stent ▲ ²	Yes	Pigtail	5 / 1.67	10
M00537190	Advanix Pancreatic Stent ▲ ²	Yes	Pigtail	5 / 1.67	11
M00537200	Advanix Pancreatic Stent ▲ ²	Yes	Pigtail	5 / 1.67	12
M00537210	Advanix Pancreatic Stent ▲ ²	Yes	Pigtail	5 / 1.67	13
M00537220	Advanix Pancreatic Stent ■	Yes	Pigtail	7 / 2.33	3
M00537230	Advanix Pancreatic Stent ▲	Yes	Pigtail	7 / 2.33	4
M00537240	Advanix Pancreatic Stent ▲	Yes	Pigtail	7 / 2.33	5
M00537250	Advanix Pancreatic Stent ▲	Yes	Pigtail	7 / 2.33	6
M00537260	Advanix Pancreatic Stent ▲	Yes	Pigtail	7 / 2.33	7
M00537270	Advanix Pancreatic Stent ▲	Yes	Pigtail	7 / 2.33	8
M00537280	Advanix Pancreatic Stent ▲	Yes	Pigtail	7 / 2.33	9
M00537290	Advanix Pancreatic Stent ▲	Yes	Pigtail	7 / 2.33	10
M00537300	Advanix Pancreatic Stent ▲	Yes	Pigtail	7 / 2.33	11
M00537310	Advanix Pancreatic Stent ▲	Yes	Pigtail	7 / 2.33	12
M00537320	Advanix Pancreatic Stent ▲	Yes	Pigtail	7 / 2.33	13
M00537330	Advanix Pancreatic Stent ▲	Yes	Pigtail	7 / 2.33	15
M00537340	Advanix Pancreatic Stent ▲	Yes	Pigtail	7 / 2.33	18



NEW Advanix™ Pancreatic Single Stents – Straight

Order Number	Description	Leading Barb	Shape	O.D. (F) / (mm)	Length (cm)
M00536000	Advanix Pancreatic Stent ■	No	Straight	3 / 1.00	2
M00536010	Advanix Pancreatic Stent ■	No	Straight	3 / 1.00	3
M00536020	Advanix Pancreatic Stent ■	No	Straight	3 / 1.00	4
M00536030	Advanix Pancreatic Stent ■	No	Straight	3 / 1.00	5
M00536040	Advanix Pancreatic Stent ■	No	Straight	3 / 1.00	6
M00536050	Advanix Pancreatic Stent ■	No	Straight	3 / 1.00	7
M00536060	Advanix Pancreatic Stent ■	No	Straight	3 / 1.00	8
M00536070	Advanix Pancreatic Stent ■	No	Straight	3 / 1.00	9

■ Trailing endoscopic marker ● Trailing radiopaque marker ▲ Leading radiopaque marker with trailing endoscopic marker

1 Stiffer stent material compared to 4F pigtail stents.

2 Stiffer stent material compared to 5F pigtail and 5F straight stents with No Leading Barb.



Stents

PANCREATIC PLASTIC STENTS (CONTINUED)

NEW Advanix™ Pancreatic Single Stents – Straight (CONTINUED)



Order Number	Description	Leading Barb	Shape	O.D. (F) / (mm)	Length (cm)
M00536080	Advanix Pancreatic Stent ■	No	Straight	3 / 1.00	10
M00536090	Advanix Pancreatic Stent ■	No	Straight	3 / 1.00	11
M00536100	Advanix Pancreatic Stent ■	No	Straight	3 / 1.00	12
M00536110	Advanix Pancreatic Stent ■	No	Straight	3 / 1.00	13
M00536120	Advanix Pancreatic Stent ● ¹	No	Straight	4 / 1.35	2
M00536130	Advanix Pancreatic Stent ● ¹	No	Straight	4 / 1.35	3
M00536140	Advanix Pancreatic Stent ▲ ¹	No	Straight	4 / 1.35	4
M00536150	Advanix Pancreatic Stent ▲ ¹	No	Straight	4 / 1.35	5
M00536160	Advanix Pancreatic Stent ▲ ¹	No	Straight	4 / 1.35	6
M00536170	Advanix Pancreatic Stent ▲ ¹	No	Straight	4 / 1.35	7
M00536180	Advanix Pancreatic Stent ▲ ¹	No	Straight	4 / 1.35	8
M00536190	Advanix Pancreatic Stent ▲ ¹	No	Straight	4 / 1.35	9
M00536200	Advanix Pancreatic Stent ▲ ¹	No	Straight	4 / 1.35	10
M00536210	Advanix Pancreatic Stent ▲ ¹	No	Straight	4 / 1.35	11
M00536220	Advanix Pancreatic Stent ▲ ¹	No	Straight	4 / 1.35	12
M00536230	Advanix Pancreatic Stent ▲ ¹	No	Straight	4 / 1.35	13
M00536240	Advanix Pancreatic Stent ●	No	Straight	5 / 1.67	2
M00536250	Advanix Pancreatic Stent ●	No	Straight	5 / 1.67	3
M00536260	Advanix Pancreatic Stent ▲	No	Straight	5 / 1.67	4
M00536270	Advanix Pancreatic Stent ▲	No	Straight	5 / 1.67	5
M00536280	Advanix Pancreatic Stent ▲	No	Straight	5 / 1.67	6
M00536290	Advanix Pancreatic Stent ▲	No	Straight	5 / 1.67	7
M00536300	Advanix Pancreatic Stent ▲	No	Straight	5 / 1.67	8
M00536310	Advanix Pancreatic Stent ▲	No	Straight	5 / 1.67	9
M00536320	Advanix Pancreatic Stent ▲	No	Straight	5 / 1.67	10
M00536330	Advanix Pancreatic Stent ▲	No	Straight	5 / 1.67	11
M00536340	Advanix Pancreatic Stent ▲	No	Straight	5 / 1.67	12
M00536350	Advanix Pancreatic Stent ▲	No	Straight	5 / 1.67	13
M00536360	Advanix Pancreatic Stent ●	Yes	Straight	5 / 1.67	2
M00536370	Advanix Pancreatic Stent ●	Yes	Straight	5 / 1.67	3
M00536380	Advanix Pancreatic Stent ▲	Yes	Straight	5 / 1.67	4
M00536390	Advanix Pancreatic Stent ▲	Yes	Straight	5 / 1.67	5
M00536400	Advanix Pancreatic Stent ▲ ²	Yes	Straight	5 / 1.67	6
M00536410	Advanix Pancreatic Stent ▲ ²	Yes	Straight	5 / 1.67	7
M00536420	Advanix Pancreatic Stent ▲ ²	Yes	Straight	5 / 1.67	8
M00536430	Advanix Pancreatic Stent ▲ ²	Yes	Straight	5 / 1.67	9
M00536440	Advanix Pancreatic Stent ▲ ²	Yes	Straight	5 / 1.67	10

■ Trailing endoscopic marker ● Trailing radiopaque marker ▲ Leading radiopaque marker with trailing endoscopic marker

¹ Stiffer stent material compared to 4F pigtail stents.

² Stiffer stent material compared to 5F pigtail and 5F straight stents with No Leading Barb.



Stents

PANCREATIC PLASTIC STENTS (CONTINUED)

NEW Advanix™ Pancreatic Single Stents – Straight (CONTINUED)



Order Number	Description	Leading Barb	Shape	O.D. (F) / (mm)	Length (cm)
M00536450	Advanix Pancreatic Stent ▲ 2	Yes	Straight	5 / 1.67	11
M00536460	Advanix Pancreatic Stent ▲ 2	Yes	Straight	5 / 1.67	12
M00536470	Advanix Pancreatic Stent ▲ 2	Yes	Straight	5 / 1.67	13
M00536480	Advanix Pancreatic Stent ■	Yes	Straight	7 / 2.33	3
M00536490	Advanix Pancreatic Stent ▲	Yes	Straight	7 / 2.33	4
M00536500	Advanix Pancreatic Stent ▲	Yes	Straight	7 / 2.33	5
M00536510	Advanix Pancreatic Stent ▲	Yes	Straight	7 / 2.33	6
M00536520	Advanix Pancreatic Stent ▲	Yes	Straight	7 / 2.33	7
M00536530	Advanix Pancreatic Stent ▲	Yes	Straight	7 / 2.33	8
M00536540	Advanix Pancreatic Stent ▲	Yes	Straight	7 / 2.33	9
M00536550	Advanix Pancreatic Stent ▲	Yes	Straight	7 / 2.33	10
M00536560	Advanix Pancreatic Stent ▲	Yes	Straight	7 / 2.33	11
M00536570	Advanix Pancreatic Stent ▲	Yes	Straight	7 / 2.33	12
M00536580	Advanix Pancreatic Stent ▲	Yes	Straight	7 / 2.33	13
M00536590	Advanix Pancreatic Stent ▲	Yes	Straight	7 / 2.33	15
M00536600	Advanix Pancreatic Stent ▲	Yes	Straight	7 / 2.33	18
M00536610	Advanix Pancreatic Stent ■	Yes	Straight	10 / 3.33	3
M00536620	Advanix Pancreatic Stent ▲	Yes	Straight	10 / 3.33	4
M00536630	Advanix Pancreatic Stent ▲	Yes	Straight	10 / 3.33	5
M00536640	Advanix Pancreatic Stent ▲	Yes	Straight	10 / 3.33	6
M00536650	Advanix Pancreatic Stent ▲	Yes	Straight	10 / 3.33	7
M00536660	Advanix Pancreatic Stent ▲	Yes	Straight	10 / 3.33	8
M00536670	Advanix Pancreatic Stent ▲	Yes	Straight	10 / 3.33	9
M00536680	Advanix Pancreatic Stent ▲	Yes	Straight	10 / 3.33	10
M00536690	Advanix Pancreatic Stent ▲	Yes	Straight	10 / 3.33	11
M00536700	Advanix Pancreatic Stent ▲	Yes	Straight	10 / 3.33	12
M00536710	Advanix Pancreatic Stent ▲	Yes	Straight	10 / 3.33	13
M00536720	Advanix Pancreatic Stent ▲	Yes	Straight	10 / 3.33	15
M00536730	Advanix Pancreatic Stent ▲	Yes	Straight	10 / 3.33	18

■ Trailing endoscopic marker ● Trailing radiopaque marker ▲ Leading radiopaque marker with trailing endoscopic marker
 1 Stiffer stent material compared to 4F pigtail stents.
 2 Stiffer stent material compared to 5F pigtail and 5F straight stents with No Leading Barb.

Stents

PANCREATIC PLASTIC STENTS (CONTINUED)

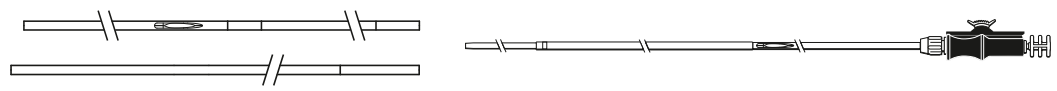

NEW NaviFlex™ RX Pancreatic Delivery System & NaviFlex Pushers



Order Number	Description	Diameter (F) / (mm)
M00535000	Pancreatic Stent RX Pusher	3 / 1.00
M00535010	Pancreatic Stent RX Pusher	4 & 5 / 1.35 & 1.67
M00535020	Pancreatic Stent Pusher	3 / 1.00
M00535030	Pancreatic Stent Pusher	4 & 5 / 1.35 & 1.67
M00535060	NaviFlex RX Pancreatic Stent Delivery System	7 / 2.33
M00535080	NaviFlex RX Pancreatic Stent Delivery System	10 / 3.33

Stents

ESOPHAGEAL STENTS

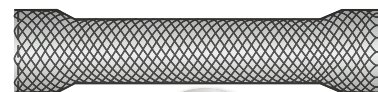
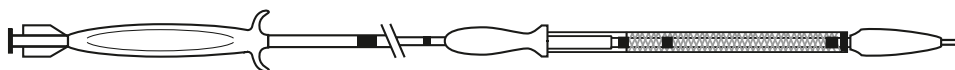

WallFlex™ Fully Covered Esophageal Stents with Permalume™ Covering (including benign indication)



Order Number	Description	Stent O.D. (mm)	Proximal / Distal Flares O.D. (mm)	Stent Length (cm)	Catheter Diameter (F) / (mm)	System Length (cm)
M00516210†	WallFlex Fully Covered Esophageal Stent	18	25 / 23	10	18.5 / 6.17	120
M00516220†	WallFlex Fully Covered Esophageal Stent	18	25 / 23	12	18.5 / 6.17	120
M00516230†	WallFlex Fully Covered Esophageal Stent	18	25 / 23	15	18.5 / 6.17	120
M00516240†	WallFlex Fully Covered Esophageal Stent	23	28 / 28	10	18.5 / 6.17	120
M00516250†	WallFlex Fully Covered Esophageal Stent	23	28 / 28	12	18.5 / 6.17	120
M00516260†	WallFlex Fully Covered Esophageal Stent	23	28 / 28	15	18.5 / 6.17	120

† Product commercialised only in countries where benign indication is approved.

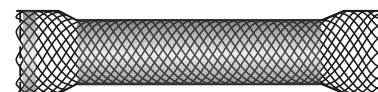
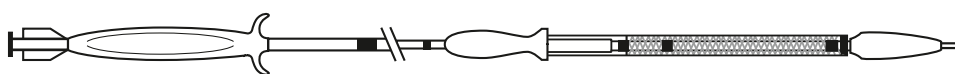

WallFlex™ Partially Covered Esophageal Stents with Permalume™ Covering



Order Number	Description	Stent O.D. (mm)	Proximal / Distal Flares O.D. (mm)	Stent Length (cm)	Covered Length (cm)	Catheter Diameter (F) / (mm)	System Length (cm)
M00516900	WallFlex Partially Covered Esophageal Stent	18	23 / 23	10	7	18.5 / 6.17	120
M00516910	WallFlex Partially Covered Esophageal Stent	18	23 / 23	12	9	18.5 / 6.17	120
M00516920	WallFlex Partially Covered Esophageal Stent	18	23 / 23	15	12	18.5 / 6.17	120
M00516930	WallFlex Partially Covered Esophageal Stent	23	28 / 28	10	7	18.5 / 6.17	120
M00516940	WallFlex Partially Covered Esophageal Stent	23	28 / 28	12	9	18.5 / 6.17	120
M00516950	WallFlex Partially Covered Esophageal Stent	23	28 / 28	15	12	18.5 / 6.17	120

Packaged one per box

Recommended Guidewire: .038in (0.97mm) 260cm Jagwire™ Guidewire, M0055662011

Stents

ESOPHAGEAL STENTS (CONTINUED)

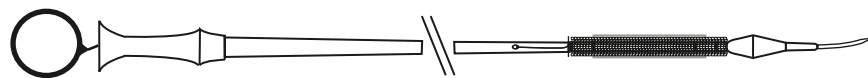

Ultraflex™ Covered Esophageal NG Stents

Proximal Release



Order Number	Description	Stent O.D. (mm)	Proximal Flare O.D. (mm)	Stent Length (cm)	Covered Length (cm)
M00513840	Ultraflex Esophageal NG Stent	18	23	10	7
M00513850	Ultraflex Esophageal NG Stent	18	23	12	9
M00513860	Ultraflex Esophageal NG Stent	18	23	15	12
M00514240	Ultraflex Esophageal NG Stent	23	28	10	7
M00514250	Ultraflex Esophageal NG Stent	23	28	12	9

Distal Release

Order Number	Description	Stent O.D. (mm)	Proximal Flare O.D. (mm)	Stent Length (cm)	Covered Length (cm)
M00513730	Ultraflex Esophageal NG Stent	18	23	10	7
M00513740	Ultraflex Esophageal NG Stent	18	23	12	9
M00513750	Ultraflex Esophageal NG Stent	18	23	15	12
M00514200	Ultraflex Esophageal NG Stent	23	28	10	7
M00514210	Ultraflex Esophageal NG Stent	23	28	12	9

Packaged one per box

Recommended Guidewire: .038in (0.97mm) 260cm Jagwire™ Guidewire, M0055662011

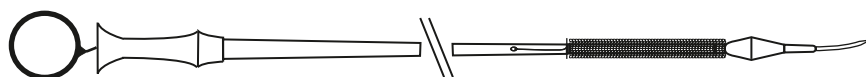

Ultraflex™ Non-covered Esophageal NG Stents

Proximal Release



Order Number	Description	Stent O.D. (mm)	Proximal Flare O.D. (mm)	Stent Length (cm)
M00513800	Ultraflex Esophageal NG Stent	18	23	7
M00513810	Ultraflex Esophageal NG Stent	18	23	10
M00513820	Ultraflex Esophageal NG Stent	18	23	12
M00513830	Ultraflex Esophageal NG Stent	18	23	15
M00514220	Ultraflex Esophageal NG Stent	23	28	7
M00514230	Ultraflex Esophageal NG Stent	23	28	12

Distal Release

Order Number	Description	Stent O.D. (mm)	Proximal Flare O.D. (mm)	Stent Length (cm)
M00513700	Ultraflex Esophageal NG Stent	18	23	7
M00513710	Ultraflex Esophageal NG Stent	18	23	10
M00513720	Ultraflex Esophageal NG Stent	18	28	15

Packaged one per box

Recommended Guidewire: .038in (0.97mm) 260cm Jagwire™ Guidewire, M0055662011

Stents

ESOPHAGEAL STENTS (CONTINUED)

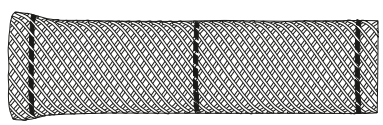
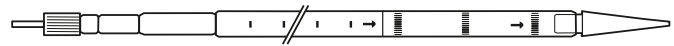

Polyflex Stent™ Self-expanding Silicone Esophageal Stents



Order Number	Description	Stent Body I.D. (mm)	Stent Flare I.D. (mm)	Stent Length (cm)	System O.D. (mm)
M00514270	Polyflex Esophageal Stent	16	20	9	12
M00514280	Polyflex Esophageal Stent	16	20	12	12
M00514290	Polyflex Esophageal Stent	16	20	15	12
M00514300	Polyflex Esophageal Stent	18	23	9	13
M00514310	Polyflex Esophageal Stent	18	23	12	13
M00514320	Polyflex Esophageal Stent	18	23	15	13
M00514330	Polyflex Esophageal Stent	21	25	9	14
M00514340	Polyflex Esophageal Stent	21	25	12	14
M00514350	Polyflex Esophageal Stent	21	25	15	14

Packaged one per box
Recommended Guidewire: .038in (0.97mm) 260cm Jagwire™ Guidewire, M0055662011

Stents

COLONIC AND DUODENAL STENTS

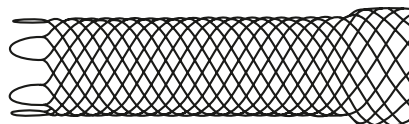
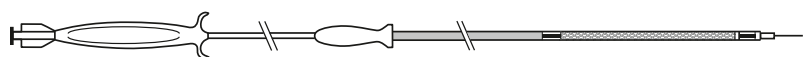

WallFlex™ Colonic Stents



Order Number	Description	Stent Body Diameter (mm)	Stent Flare Diameter (mm)	Expanded Stent Length (cm)	Working Length (cm)	Catheter Diameter (F) / (mm)
M00565100	WallFlex Colonic Stent	22	27	6	230	10 / 3.33
M00565110	WallFlex Colonic Stent	22	27	9	230	10 / 3.33
M00565120	WallFlex Colonic Stent	22	27	12	230	10 / 3.33
M00565130	WallFlex Colonic Stent	22	27	6	135	10 / 3.33
M00565140	WallFlex Colonic Stent	22	27	9	135	10 / 3.33
M00565150	WallFlex Colonic Stent	22	27	12	135	10 / 3.33
M00565040	WallFlex Colonic Stent	25	30	6	230	10 / 3.33
M00565050	WallFlex Colonic Stent	25	30	9	230	10 / 3.33
M00565060	WallFlex Colonic Stent	25	30	12	230	10 / 3.33
M00565070	WallFlex Colonic Stent	25	30	6	135	10 / 3.33
M00565080	WallFlex Colonic Stent	25	30	9	135	10 / 3.33
M00565090	WallFlex Colonic Stent	25	30	12	135	10 / 3.33

Packaged one per box

Recommended Guidewire Systems 230cm: .035in (0.89mm) Dreamwire™ High Performance Guidewire Stiff Shaft, 450cm: M00556161 Straight Dream Tip™, M00556171 Angled Dream Tip™ or .035 in (0.89mm) Jagwire™ Guidewire Stiff Shaft, 450cm: M0055660011 Straight Tip, M0055661011 Angled Tip or .035in (0.89mm) Super Stiff Wire, 500cm: H965180010

Systems 135cm: .035in (0.89mm) Dreamwire™ High Performance Guidewire Stiff Shaft, 260cm: M00556121 Straight Tip, M00556131 Angled Tip or .035in (0.89mm) Jagwire™ Guidewire Stiff Shaft, 260cm: M00557661 Straight Tip

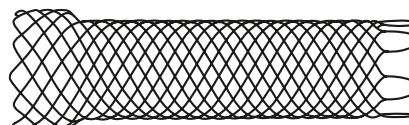
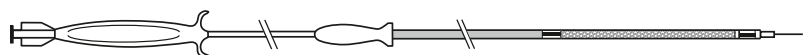

WallFlex™ Duodenal Stents



Order Number	Description	Stent Body Diameter (mm)	Stent Flare Diameter (mm)	Expanded Stent Length (cm)	Working Length (cm)	Catheter Diameter (F) / (mm)
M00565010	WallFlex Duodenal Stent	22	27	6	230	10 / 3.33
M00565020	WallFlex Duodenal Stent	22	27	9	230	10 / 3.33
M00565030	WallFlex Duodenal Stent	22	27	12	230	10 / 3.33

Packaged one per box

Recommended Guidewires: .035in (0.89mm) Dreamwire™ High Performance Guidewire Stiff Shaft, 450cm: M00556161 Straight Dream Tip™, M00556171 Angled Dream Tip™ or .035in (0.89mm) Jagwire™ Guidewire Stiff Shaft, 450cm: M0055660011 Straight Tip, M0055661011 Angled Tip or .035in (0.89mm) Super Stiff Wire, 500cm: H965180010

Stents

COLONIC AND DUODENAL STENTS (CONTINUED)

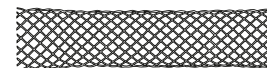

Wallstent™ Colonic and Duodenal Stents

Order Number	Description	Expanded Stent Diameter (mm)	Expanded Stent Length (cm)	Working Length (cm)	Catheter Diameter (F) / (mm)
M00565560	Wallstent Colonic and Duodenal Stent	20	6	230	10 / 3.33
M00565570	Wallstent Colonic and Duodenal Stent	20	9	230	10 / 3.33
M00565620	Wallstent Colonic and Duodenal Stent	20	6	135	10 / 3.33
M00565630	Wallstent Colonic and Duodenal Stent	20	9	135	10 / 3.33
M00565580	Wallstent Colonic and Duodenal Stent	22	6	230	10 / 3.33
M00565590	Wallstent Colonic and Duodenal Stent	22	9	230	10 / 3.33
M00565640	Wallstent Colonic and Duodenal Stent	22	6	135	10 / 3.33
M00565650	Wallstent Colonic and Duodenal Stent	22	9	135	10 / 3.33

Packaged one per box

Recommended Guidewire Systems 230cm: .035in (0.89mm) Dreamwire™ High Performance Guidewire Stiff Shaft, 450cm: M00556161 Straight Dream Tip™, M00556171 Angled Dream Tip™ or .035in (0.89mm) Jagwire™ Guidewire Stiff Shaft, 450cm: M0055660011 Straight Tip, M0055661011 Angled Tip or .035in (0.89mm) Super Stiff Wire, 500cm: H965180010

Recommended Guidewire Systems 135cm: .035in (0.89mm) Dreamwire™ High Performance Guidewire Stiff Shaft, 260cm: M00556121 Straight Tip, M00556131 Angled Tip or .035in (0.89mm) Jagwire™ Guidewire Stiff Shaft, 260cm: M00557661 Straight Tip

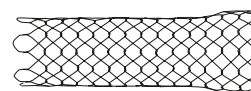
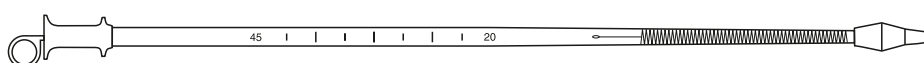

Ultraflex Precision™ Colonic Stents

Order Number	Description	Stent Body Diameter (mm)	Stent Flare Diameter (mm)	Expanded Stent Length (cm)	Working Length (cm)	Catheter Tip Diameter (F) / (mm)
M00557330	Ultraflex Precision Colonic Stent	25	30	5.7	100	22 / 7.33
M00557360	Ultraflex Precision Colonic Stent	25	30	8.7	100	22 / 7.33
M00557380	Ultraflex Precision Colonic Stent	25	30	11.7	100	22 / 7.33

Packaged one per box

Recommended Guidewire: .038in (0.97mm) Jagwire™ Guidewire, Order No. M0055662011

Stents – While in Stock



WallFlex™ Biliary RX Fully Covered Stents with Permalume™ Covering



Order Number	Description	Diameter (mm)	Length (mm)	Catheter Diameter (F) / (mm)	Guidewire Diameter (in) / (mm)
M00570500	WallFlex RX Biliary w/Permalume	8	60	8.5 / 2.83	.035 / 0.89
M00570510	WallFlex RX Biliary w/Permalume	8	80	8.5 / 2.83	.035 / 0.89
M00570520	WallFlex RX Biliary w/Permalume	10	40	8.5 / 2.83	.035 / 0.89
M00570530	WallFlex RX Biliary w/Permalume	10	60	8.5 / 2.83	.035 / 0.89
M00570540	WallFlex RX Biliary w/Permalume	10	80	8.5 / 2.83	.035 / 0.89

Packaged one per box

Recommended Guidewire: .035in (0.89mm) Dreamwire™ High Performance Guidewire Stiff Shaft, 260cm or .035in (0.89mm) Dreamwire™ High Performance Guidewire, 260cm

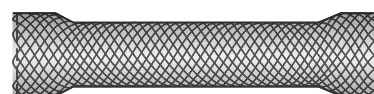
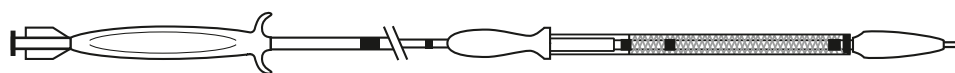

WallFlex™ Fully Covered Esophageal Stents with Permalume™ Covering



Order Number	Description	Stent O.D. (mm)	Proximal / Distal Flares O.D. (mm)	Stent Length (cm)	Catheter Diameter (F) / (mm)	System Length (cm)
M00516700	WallFlex Fully Covered Esophageal Stent	18	25 / 23	10	18.5 / 6.17	120
M00516710	WallFlex Fully Covered Esophageal Stent	18	25 / 23	12	18.5 / 6.17	120
M00516720	WallFlex Fully Covered Esophageal Stent	18	25 / 23	15	18.5 / 6.17	120
M00516730	WallFlex Fully Covered Esophageal Stent	23	28 / 28	10	18.5 / 6.17	120
M00516740	WallFlex Fully Covered Esophageal Stent	23	28 / 28	12	18.5 / 6.17	120
M00516750	WallFlex Fully Covered Esophageal Stent	23	28 / 28	15	18.5 / 6.17	120

Packaged one per box

Recommended Guidewire: .038in (0.97mm) 260cm Jagwire™ Guidewire, M0055662011



CRE™ WIREGUIDED
INDICATED FOR USE IN THE
DASE
PROCEDURE
BALLOON DILATOR

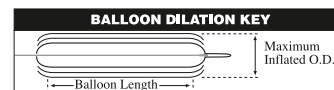

Dilation

CRE™ CONTROLLED RADIAL EXPANSION DILATION BALLOONS

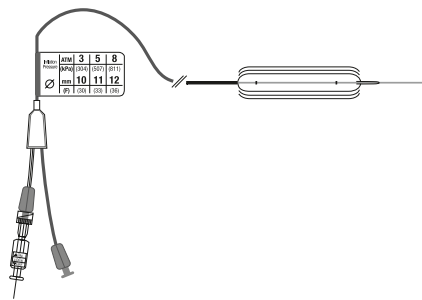

CRE™ Wireguided Esophageal/Pyloric/Biliary Dilation Balloons (including DASE indication)



Order Number	Inflated O.D. (mm)	Balloon Length (cm)	Inflation Pressure (ATM)	Inflation Pressure (kPa)	Minimum Working Channel (mm)*	Catheter Diameter (F) / (mm)	Working Length (cm)	Units
M00558600	6-7-8	5.5	3-6-10	304-608-1013	2.8/3.2 (A)/3.2 (B)	7.5 / 2.50	180	box 1
M00558610	8-9-10	5.5	3-5.5-9	304-557-912	2.8/3.2 (A)/3.2 (B)	7.5 / 2.50	180	box 1
M00558620	10-11-12	5.5	3-5-8	304-507-811	2.8/3.2 (A)/3.2 (B)	7.5 / 2.50	180	box 1
M00558630	12-13.5-15	5.5	3-4.5-8	304-456-811	2.8/3.2 (A)/3.2 (B)	7.5 / 2.50	180	box 1
M00558640	15-16.5-18	5.5	3-4.5-7	304-456-709	2.8/3.2 (A)/4.2 (B)	7.5 / 2.50	180	box 1
M00558650**	18-19-20	5.5	3-4.5-6	304-456-608	2.8/3.2 (A)/4.2 (B)	7.5 / 2.50	180	box 1

Recommended Inflation Device: Alliance™ II Integrated Inflation System Re-usable Handle M00550620, Sterile Syringe M00550601
Pre-assembled .035in (0.89mm) Guidewire

(A) = Alimentary tract

(B) = Biliary tract (sphincter of Oddi)

* Requires a 2.8mm Olympus brand endoscope channel or a 3.2mm Pentax or Fujinon brand endoscope channel for alimentary tract

** Esophageal and biliary applications only

This product contains no detectable latex.

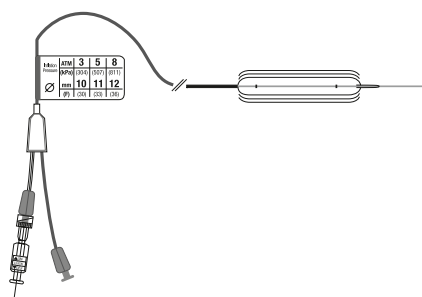

CRE™ Wireguided Esophageal/Pyloric/Colonic/Biliary Dilation Balloons (including DASE indication)



Order Number	Inflated O.D. (mm)	Balloon Length (cm)	Inflation Pressure (ATM)	Inflation Pressure (kPa)	Minimum Working Channel (mm)*	Catheter Diameter (F) / (mm)	Working Length (cm)	Units
M00558660	6-7-8	5.5	3-6-10	304-608-1013	2.8/3.2 (A)/3.2 (B)	7.5 / 2.50	240	box 1
M00558670	8-9-10	5.5	3-5.5-9	304-557-912	2.8/3.2 (A)/3.2 (B)	7.5 / 2.50	240	box 1
M00558680	10-11-12	5.5	3-5-8	304-507-811	2.8/3.2 (A)/3.2 (B)	7.5 / 2.50	240	box 1
M00558690	12-13.5-15	5.5	3-4.5-8	304-456-811	2.8/3.2 (A)/3.2 (B)	7.5 / 2.50	240	box 1
M00558700	15-16.5-18	5.5	3-4.5-7	304-456-709	2.8/3.2 (A)/4.2 (B)	7.5 / 2.50	240	box 1
M00558710**	18-19-20	5.5	3-4.5-6	304-456-608	2.8/3.2 (A)/4.2 (B)	7.5 / 2.50	240	box 1

Recommended Inflation Device: Alliance™ II Integrated Inflation System Re-usable Handle M00550620, Sterile Syringe M00550601

Pre-assembled .035in (0.89mm) Guidewire

(A) = Alimentary tract

(B) = Biliary tract (sphincter of Oddi)

* Requires a 2.8mm Olympus brand endoscope channel or a 3.2mm Pentax or Fujinon brand endoscope channel for alimentary tract

** Esophageal, colonic and biliary applications only

This product contains no detectable latex.

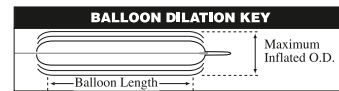

Dilation

CRE™ CONTROLLED RADIAL EXPANSION DILATION BALLOONS (CONTINUED)

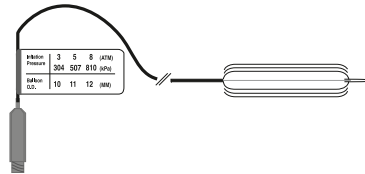

CRE™ Fixed Wire Dilation Balloons



Order Number	Inflated O.D. (mm)	Balloon Length (cm)	Inflation Pressure (ATM)	Inflation Pressure (kPa)	Minimum Working Channel (mm)	Catheter Diameter (F) / (mm)	Working Length (cm)	Units
M00558330	6-7-8	8	3-6-10	304-608-1013	2.8	6 / 2.00	180	box 1
M00558340	8-9-10	8	3-5.5-9	304-557-912	2.8	6 / 2.00	180	box 1
M00558350	10-11-12	8	3-5-8	304-507-810	2.8	6 / 2.00	180	box 1
M00558360	12-13.5-15	8	3-4.5-8	304-456-810	2.8	6 / 2.00	180	box 1
M00558361	12-13.5-15	8	3-4.5-8	304-456-810	2.8	6 / 2.00	180	box 5
M00558370	15-16.5-18	8	3-4.5-7	304-456-709	2.8	6 / 2.00	180	box 1
M00558371	15-16.5-18	8	3-4.5-7	304-456-709	2.8	6 / 2.00	180	box 5
M00558380	18-19-20	8	3-4.5-6	304-456-608	2.8	6 / 2.00	180	box 1
M00558381	18-19-20	8	3-4.5-6	304-456-608	2.8	6 / 2.00	180	box 5

Recommended Inflation Device: Alliance™ II Integrated Inflation System Re-usable Handle M00550620, Sterile Syringe M00550601
 This product contains no detectable latex.

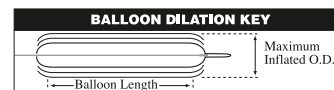

Dilation

MAX FORCE™ TTS DILATION BALLOONS

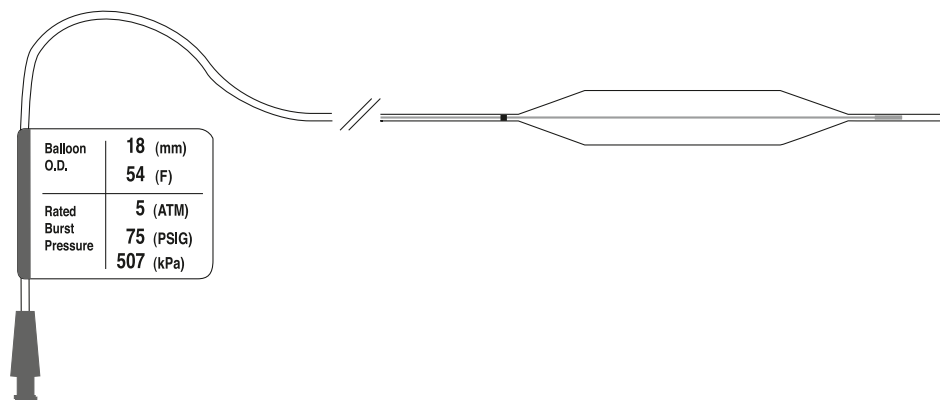

Max Force™ TTS Esophageal Dilation Balloons

Order Number	Inflated O.D. (mm)	Balloon Length (cm)	Inflation Pressure (ATM)	Inflation Pressure (kPa)	Minimum Working Channel (mm)	Catheter Diameter (F) / (mm)	Working Length (cm)	Units
M00589060	6	6	10	1013	2.8	6 / 2.00	180	box 1
M00589080	8	6	10	1013	2.8	6 / 2.00	180	box 1
M00589100	10	6	7	709	2.8	6 / 2.00	180	box 1
M00589120	12	6	7	709	2.8	6 / 2.00	180	box 1
M00589140	14	6	7	709	2.8	6 / 2.00	180	box 1
M00589150	15	6	5	507	2.8	6 / 2.00	180	box 1
M00589160	16	6	5	507	2.8	6 / 2.00	180	box 1
M00589180	18	6	5	507	2.8	6 / 2.00	180	box 1

Recommended Inflation Device: Alliance™ II Integrated Inflation System Re-usable Handle M00550620, Sterile Syringe M00550601
 This product contains no detectable latex.

Rigiflex™ II Achalasia Dilation Balloons*

Order Number	Inflated O.D. (mm)	Balloon Length (cm)	Catheter Diameter (F) / (mm)	Working Length (cm)	Recommended Guidewire (in) / (mm)**	Units
M00554500	30	10	14 / 4.67	90	.038 / 0.97	box 1
M00554510	35	10	14 / 4.67	90	.038 / 0.97	box 1
M00554520	40	10	14 / 4.67	90	.038 / 0.97	box 1

* Product shipped sterile. Recommended use with Achalasia Pneumatic Hand Pump and Monitor, M00553200

** Guidewire included with Rigiflex™ II Balloon Dilation Catheter

This product contains no detectable latex.

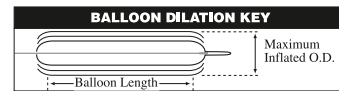

Dilation

INFLATION SYSTEMS

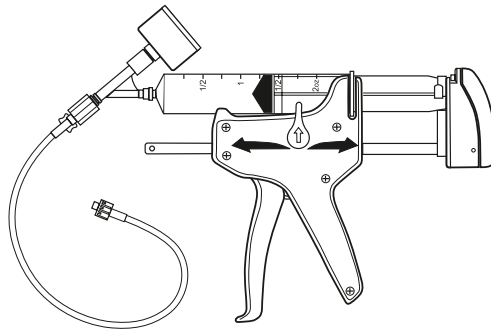

Alliance™ II Inflation System

Order Number	Description	Units
M00550620	Alliance™ II Inflation Handle	box 1
M00550601	⊗ 60ml Syringe/Gauge Assembly	box 5

DILATION ACCESSORIES

Inflation/Deflation Devices and Accessories

Order Number	Description	Units
M00553200	Achalasia Pneumatic Inflator and Monitor	box 1

RX Biliary Dilation Balloons are located in the RX Biliary Section on page 7

Biliary Dilation Balloons are located in the Biliary Section on page 16

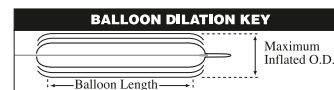

Dilation – While in Stock

CRE™ CONTROLLED RADIAL EXPANSION DILATION BALLOONS

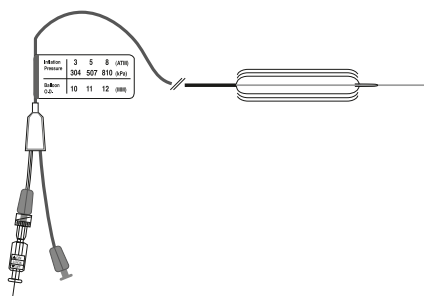

CRE™ Wireguided Esophageal/Pyloric Dilation Balloons



Order Number	Inflated O.D. (mm)	Balloon Length (cm)	Inflation Pressure (ATM)	Inflation Pressure (kPa)	Minimum Working Channel (mm)	Catheter Diameter (F) / (mm)	Working Length (cm)	Units
M00558390	6-7-8	5.5	3-6-10	304-608-1013	2.8	7.5 / 2.50	180	box 1
M00558400	8-9-10	5.5	3-5.5-9	304-557-912	2.8	7.5 / 2.50	180	box 1
M00558410	10-11-12	5.5	3-5-8	304-507-810	2.8	7.5 / 2.50	180	box 1
M00558420	12-13.5-15	5.5	3-4.5-8	304-456-810	2.8	7.5 / 2.50	180	box 1
M00558430	15-16.5-18	5.5	3-4.5-7	304-456-709	2.8/3.2*	7.5 / 2.50	180	box 1
M00558440**	18-19-20	5.5	3-4.5-6	304-456-608	2.8/3.2*	7.5 / 2.50	180	box 1

Recommended Inflation Device: Alliance™ II Integrated Inflation System Re-usable Handle M00550620, Sterile Syringe M00550601
 Pre-assembled .035in (0.89mm) Guidewire
 * Requires a 2.8mm Olympus brand endoscope channel or a 3.2mm Pentax or Fujinon brand endoscope channel for alimentary tract
 ** Esophageal application only
This product contains no detectable latex.

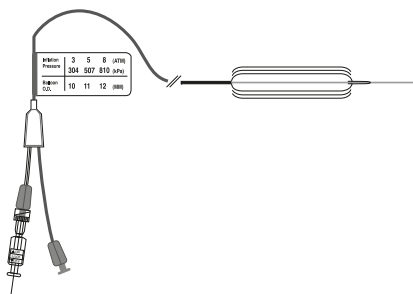

CRE™ Wireguided Esophageal/Pyloric/Colonic Dilation Balloons



Order Number	Inflated O.D. (mm)	Balloon Length (cm)	Inflation Pressure (ATM)	Inflation Pressure (kPa)	Minimum Working Channel (mm)	Catheter Diameter (F) / (mm)	Working Length (cm)	Units
M00558450	6-7-8	5.5	3-6-10	304-608-1013	2.8/3.2*	7.5 / 2.50	240	box 1
M00558460	8-9-10	5.5	3-5.5-9	304-557-912	2.8/3.2*	7.5 / 2.50	240	box 1
M00558470	10-11-12	5.5	3-5-8	304-507-810	2.8/3.2*	7.5 / 2.50	240	box 1
M00558480	12-13.5-15	5.5	3-4.5-8	304-456-810	2.8/3.2*	7.5 / 2.50	240	box 1
M00558490	15-16.5-18	5.5	3-4.5-7	304-456-709	2.8/3.2*	7.5 / 2.50	240	box 1
M00558500**	18-19-20	5.5	3-4.5-6	304-456-608	2.8/3.2*	7.5 / 2.50	240	box 1

Recommended Inflation Device: Alliance™ II Integrated Inflation System Re-usable Handle M00550620, Sterile Syringe M00550601
 Pre-assembled .035in (0.89mm) Guidewire
 * Requires a 2.8mm Olympus brand endoscope channel or a 3.2mm Pentax or Fujinon brand endoscope channel for alimentary tract
 ** Esophageal and colonic applications only
This product contains no detectable latex.

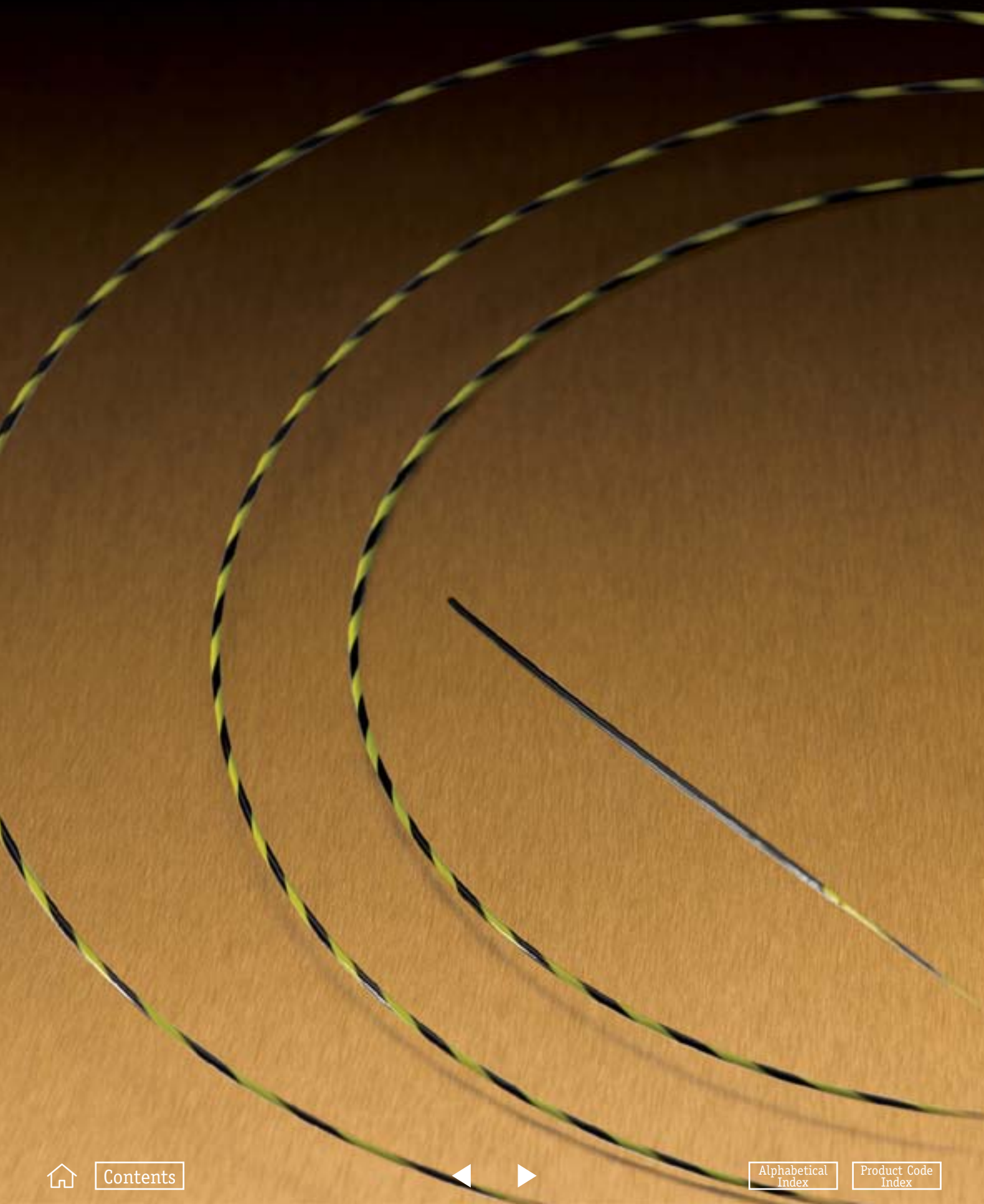

Guidewires

HIGH PERFORMANCE

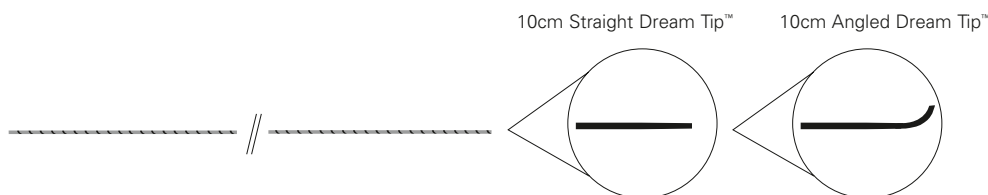

Dreamwire™ High Performance Guidewires



Order Number	Description	O.D. (in) / (mm)	Length (cm)	Dream Tip Style	Units
M00556101	Dreamwire Standard	.035 / 0.89	260	Straight	box 2
M00556111	Dreamwire Standard	.035 / 0.89	260	Angled	box 2
M00556121	Dreamwire Stiff Shaft	.035 / 0.89	260	Straight	box 2
M00556131	Dreamwire Stiff Shaft	.035 / 0.89	260	Angled	box 2
M00556141	Dreamwire Standard	.035 / 0.89	450	Straight	box 2
M00556151	Dreamwire Standard	.035 / 0.89	450	Angled	box 2
M00556161	Dreamwire Stiff Shaft	.035 / 0.89	450	Straight	box 2
M00556171	Dreamwire Stiff Shaft	.035 / 0.89	450	Angled	box 2

5cm Jagwire™ Guidewire Tip

10cm Straight Dream Tip™

10cm Angled Dream Tip™



Hydra Jagwire™ High Performance Guidewires



Order Number	Description	O.D. (in) / (mm)	Length (cm)	Dream Tip Style	Units
M00556001	Hydra Jagwire Standard	.035 / 0.89	260	Straight	box 2
M00556011	Hydra Jagwire Standard	.035 / 0.89	260	Angled	box 2
M00556021	Hydra Jagwire Stiff Shaft	.035 / 0.89	260	Straight	box 2
M00556031	Hydra Jagwire Stiff Shaft	.035 / 0.89	260	Angled	box 2
M00556041	Hydra Jagwire Standard	.035 / 0.89	450	Straight	box 2
M00556051	Hydra Jagwire Standard	.035 / 0.89	450	Angled	box 2
M00556061	Hydra Jagwire Stiff Shaft	.035 / 0.89	450	Straight	box 2
M00556071	Hydra Jagwire Stiff Shaft	.035 / 0.89	450	Angled	box 2

Hydra Jagwire Guidewire may remain in place during sphincterotomy. See "Instructions for Use" for details.

Guidewires

HIGH PERFORMANCE (CONTINUED)

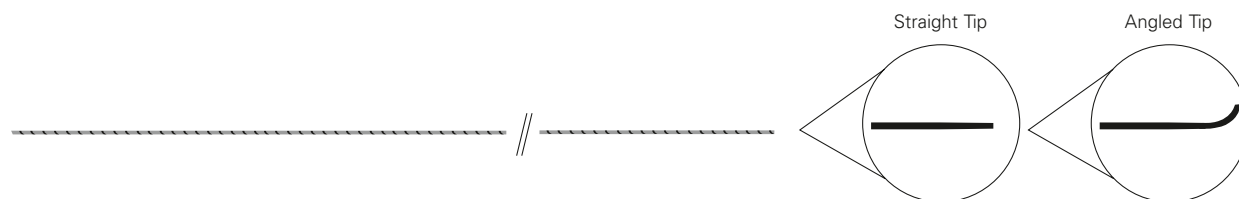

Jagwire™ High Performance Guidewires



Order Number	Description	O.D. (in) / (mm)	Length (cm)	Tip Style	Units
M00556481	Jagwire Stiff Shaft	.025 / 0.64	260	Straight	box 2
M00556491	Jagwire Stiff Shaft	.025 / 0.64	260	Angled	box 2
M00556461	Jagwire Standard	.025 / 0.64	260	Straight	box 2
M00557641	Jagwire Standard	.035-.027 / 0.89-0.69	260	Straight	box 2
M00557651	Jagwire Standard	.035-.027 / 0.89-0.69	260	Angled	box 2
M00557661	Jagwire Stiff Shaft	.035-.027 / 0.89-0.69	260	Straight	box 2
M00557671	Jagwire Stiff Shaft	.035-.027 / 0.89-0.69	260	Angled	box 2
M00556561	Jagwire Standard	.025 / 0.64	450	Straight	box 2
M00556511	Jagwire Standard	.025 / 0.64	450	Angled	box 2
M00556521	Jagwire Stiff Shaft	.025 / 0.64	450	Straight	box 2
M00556531	Jagwire Stiff Shaft	.025 / 0.64	450	Angled	box 2
M00556581	Jagwire Standard	.035-.027 / 0.89-0.69	450	Straight	box 2
M00556591	Jagwire Standard	.035-.027 / 0.89-0.69	450	Angled	box 2
M00556601	Jagwire Stiff Shaft	.035-.027 / 0.89-0.69	450	Straight	box 2
M00556611	Jagwire Stiff Shaft	.035-.027 / 0.89-0.69	450	Angled	box 2
M00556621	Jagwire Stiff Shaft	.038 / 0.97	260	Straight	box 2

Jagwire Guidewire may remain in place during sphincterotomy. See "Instructions for Use" for details.

Jagwire™ High Performance Guidewires – Extendable Jagwire



Order Number	Description	O.D. (in) / (mm)	Length (cm)	Tip Style	Units
M00556902	Jagwire Jag Tail	.035 / 0.89	200	Guidewire Extension	box 5
M00556841	Jagwire Standard	.035-.027 / 0.89-0.69	260	Straight	box 2
M00556851	Jagwire Standard	.035-.027 / 0.89-0.69	260	Angled	box 2
M00556861	Jagwire Stiff Shaft	.035-.027 / 0.89-0.69	260	Straight	box 2
M00556871	Jagwire Stiff Shaft	.035-.027 / 0.89-0.69	260	Angled	box 2

Jagwire Guidewire may remain in place during sphincterotomy. See "Instructions for Use" for details.

Guidewires

HIGH PERFORMANCE (CONTINUED)

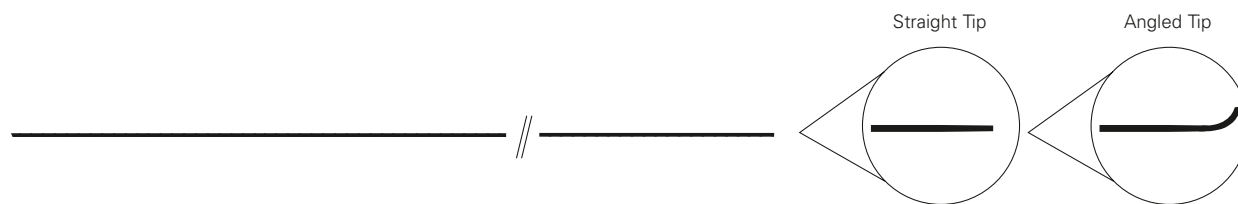

NaviPro™ 100% Hydrophilic Guidewires



Order Number	Description	O.D. (in) / (mm)	Length (cm)	Tip Style	Units
M00556191	NaviPro Standard	.018 / 0.46	260	Angled	box 5
M00556181	NaviPro Standard	.018 / 0.46	260	Straight	box 5
M00556211	NaviPro Standard	.025 / 0.64	260	Angled	box 5
M00556201	NaviPro Standard	.025 / 0.64	260	Straight	box 5
M00556231	NaviPro Standard	.035 / 0.89	260	Angled	box 5
M00556221	NaviPro Standard	.035 / 0.89	260	Straight	box 5
M00556251	NaviPro Stiff Shaft	.035 / 0.89	260	Angled	box 5
M00556241	NaviPro Stiff Shaft	.035 / 0.89	260	Straight	box 5

EXCHANGE

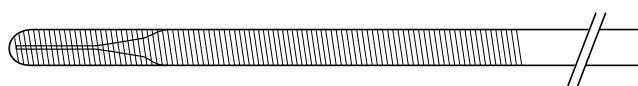

Pathfinder™ Exchange Guidewire



Order Number	Description	O.D. (in) / (mm)	Length (cm)	Tip Style	Units
M00551591	Pathfinder Exchange Guidewire Stiff Shaft	.018 / 0.46	450	Shapeable	box 2

STANDARD

Amplatz™ Super Stiff Guidewire



Order Number	Description	O.D. (in) / (mm)	Length (cm)	Tip Style	Units
M00550090	Amplatz Super Stiff Guidewire	.038 / 0.97	260	Straight	box 1

Wallstent™ Super Stiff Guidewire



Order Number	Description	O.D. (in) / (mm)	Length (cm)	Tip Style	Units
H965180011	Wallstent Super Stiff Guidewire	.035 / 0.89	500	Tapered	box 5

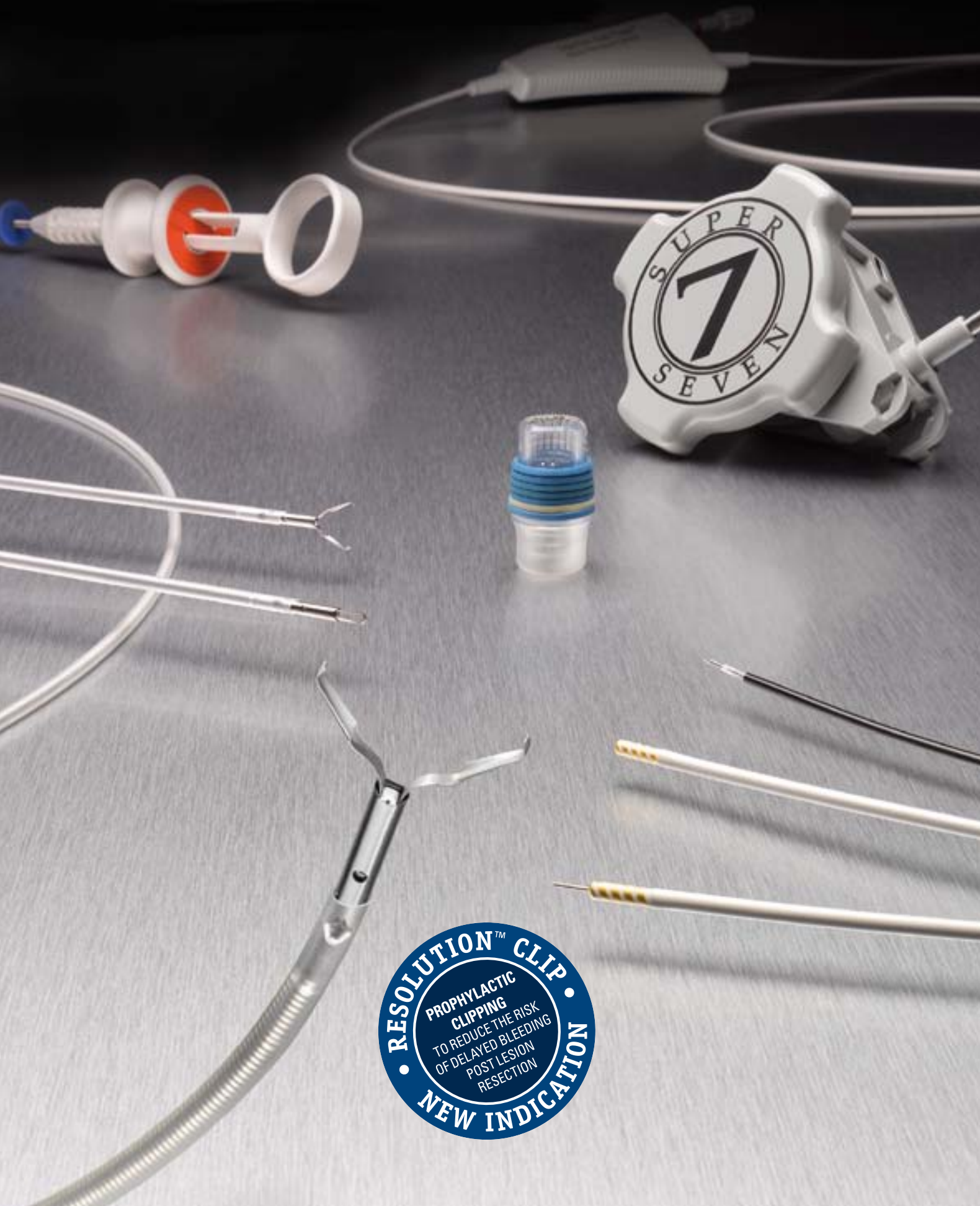

RESOLUTION™ CLIP
PROPHYLACTIC
CLIPPING
TO REDUCE THE RISK
OF DELAYED BLEEDING
POST LESION
RESECTION
NEW INDICATION

Hemostasis

CLIPPING DEVICES

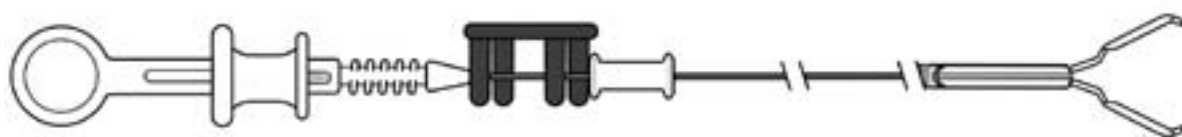

Resolution™ Clip



Order Number	Description	Working Length (cm)	Minimum Working Channel (mm)	Clip Opening (mm)	Units
M00522600	Resolution Clip	155	2.8	11	box 1
M00522601	Resolution Clip	155	2.8	11	box 10
M00522602	Resolution Clip	155	2.8	11	box 20
M00522610	Resolution Clip	235	2.8	11	box 1
M00522611	Resolution Clip	235	2.8	11	box 10
M00522612	Resolution Clip	235	2.8	11	box 20

MR Conditional per ASTM F2503

MULTIPLE BAND LIGATORS

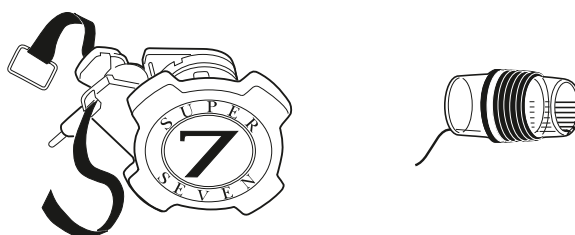

Speedband Superview Super 7™ Multiple Band Ligators



Order Number	Description	Minimum Working Channel (mm)	Scope O.D. (mm)	Bands / Ligating Unit	Units
M00542250	Super 7 Band Ligator	2.8	8.6-11.5	7	box 1
M00542251	Super 7 Band Ligator	2.8	8.6-11.5	7	box 2
M00542253	Super 7 Band Ligator	2.8	8.6-11.5	7	box 4

Irrigation catheter supplied in each kit

Hemostasis

BIPOLAR ELECTROHEMOSTASIS CATHETERS

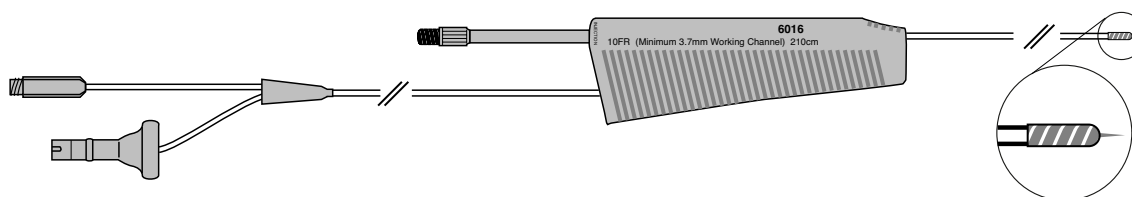

Injection Gold Probe™ Electrohemostasis/Injection Catheters



Order Number	Description	O.D. (F) / (mm)	Gauge	Needle O.D. (mm)	I.D. (mm)	Minimum Working Channel (mm)	Working Length (cm)	Units
M00560150	Injection Gold Probe Catheter	7 / 2.33	25	0.51	0.24	2.8	210	box 1
M00560160	Injection Gold Probe Catheter	10 / 3.33	25	0.51	0.24	3.7	210	box 1

Type Generator/Connector: Please refer to Electrosurgical Bipolar Cable Adaptors

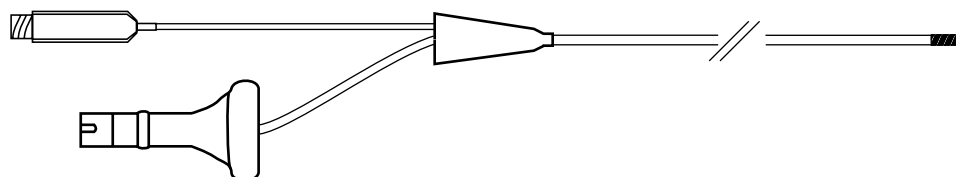

Gold Probe™ Electrohemostasis Catheters

Order Number	Description	O.D. (F) / (mm)	Minimum Working Channel (mm)	Working Length (cm)	Units
M00560070	Gold Probe Catheter	7 / 2.33	2.8	300	box 1
M00560071	Gold Probe Catheter	7 / 2.33	2.8	300	box 5
M00560100	Gold Probe Catheter	10 / 3.33	3.7	300	box 1
M00560101	Gold Probe Catheter	10 / 3.33	3.7	300	box 5
M00560220	Gold Probe Catheter	7 / 2.33	2.8	350	box 1

Type Generator/Connector: Please refer to Electrosurgical Bipolar Cable Adaptors

Hemostasis

NEEDLES

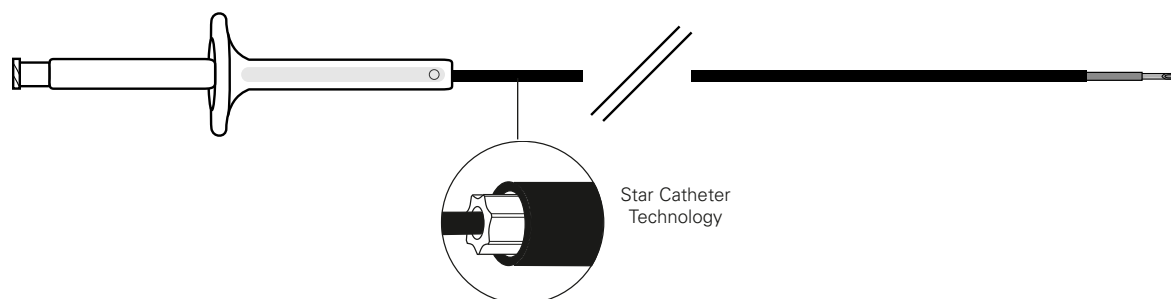

Interject™ Sclerotherapy Needles*



Order Number	Description	Sheath Design	Sheath O.D. (mm)	Gauge	Needle O.D. (mm)	I.D. (mm)	Maximum Needle Extension Length (mm)	Working Length (cm)	Units
M00518151	Interject Sclerotherapy Needle	Contrast	1.8	23	0.64	0.32	4	200	box 5
M00518161	Interject Sclerotherapy Needle	Contrast	1.8	25	0.51	0.24	4	200	box 5
M00518251	Interject Sclerotherapy Needle	Contrast	1.8	23	0.64	0.32	6	200	box 5
M00518261	Interject Sclerotherapy Needle	Contrast	1.8	25	0.51	0.24	6	200	box 5
M00518351	Interject Sclerotherapy Needle	Contrast	2.3	23	0.64	0.32	4	240	box 5
M00518361	Interject Sclerotherapy Needle	Contrast	2.3	25	0.51	0.24	4	240	box 5

* With Star Catheter Technology

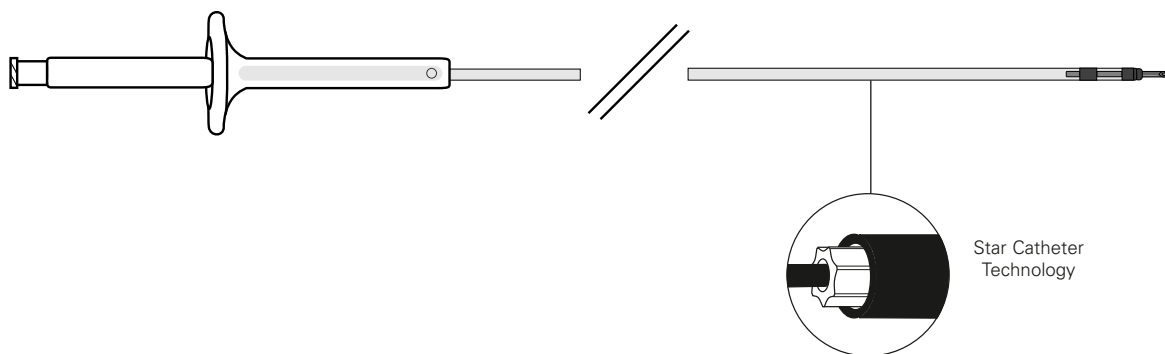

Interject™ Clear Sclerotherapy Needles*



Order Number	Description	Sheath Design	Sheath O.D. (mm)	Gauge	Needle O.D. (mm)	I.D. (mm)	Maximum Needle Extension Length (mm)	Working Length (cm)	Units
M00518111	Interject Sclerotherapy Needle	Clear	1.8	25	0.51	0.24	4	200	box 5
M00518301	Interject Sclerotherapy Needle	Clear	2.3	23	0.64	0.32	4	240	box 5
M00518311	Interject Sclerotherapy Needle	Clear	2.3	25	0.51	0.24	4	240	box 5

* With Star Catheter Technology

Hemostasis

NEEDLES (CONTINUED)

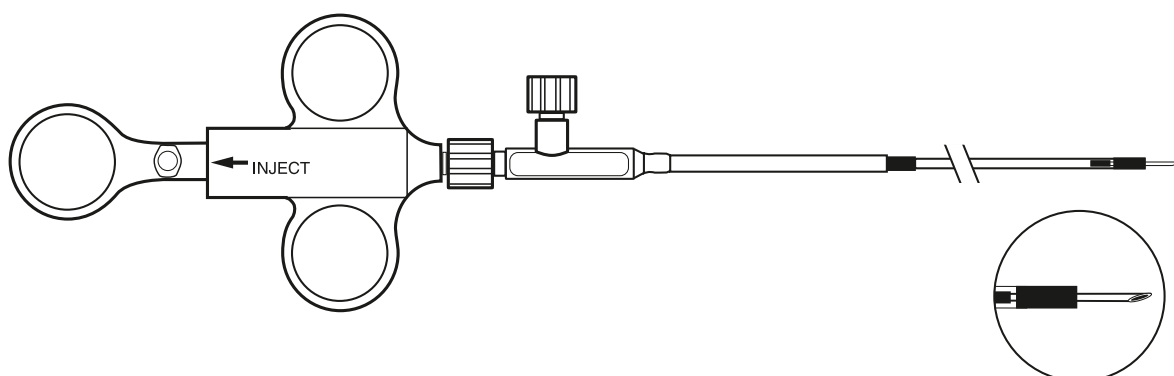

Optiflo™ Hemostasis Catheters



Order Number	Description	Needle			Sheath O.D. (mm)	Working Length (cm)	Working Channel (mm)	Units
		Gauge	O.D. (mm)	I.D. (mm)				
M00511731	Optiflo Hemostasis Catheter	23	0.64	0.32	2.3	200	2.8	box 5
M00511751	Optiflo Hemostasis Catheter	25	0.51	0.24	2.3	200	2.8	box 5

ELECTROSURGICAL BIPOLAR CABLE ADAPTORS

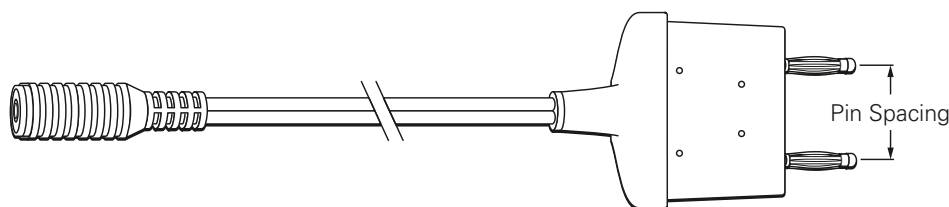

Electrosurgical Bipolar Cable Adaptors

Order Number	Description	Fix Pin Spacing (mm)	Generator Compatibility*	Units
M00561440	Bipolar Cable Adaptor	18	EMC (Coagulasem Dolley)	box 1
M00561450	Bipolar Cable Adaptor	22	ERBE (VIO International, VIO 100C, ICC Series, VIO 200D), EMC Dolley, Olympus (ESG100, PSD60)**	box 1
M00561460	Bipolar Cable Adaptor	25	Lamidey (Optima 4)	box 1
M00561470	Bipolar Cable Adaptor	28	Valleylab®, Lamidey (Duo), Bovie (Aaron 3250™, Aaron 1250™), Olympus (UES10, UES30, Surgemaster, ESG100 **, PSD60 **), Bowa, Soring, ConMed™ Sabre Genesys™	box 1
M00561480	Bipolar Cable Adaptor	28 with Third Pin	ConMed® (System 5000), Bovie (Aaron 2250™), Ethicon®	box 1
M00561490	Bipolar Cable Adaptor	32 with Third Pin	ConMed (Sabre 180, Excalibur, System 7550)	box 1
M00561500	Bipolar Cable Adaptor	39	Codman, Malis®	box 1

Bipolar Cable Adaptors are used to connect Gold Probe™ and Injection Gold Probe™ with the above mentioned generators.

* For generators and their associated cable adaptors not listed above, please contact your Boston Scientific Representative

** Some variations in faceplates may exist within a generator model. We recommend that you confirm pin spacing prior to ordering

ENTIRE POLYPECTOMY SNARE PORTFOLIO • BOSTON SCIENTIFIC •

INDICATED FOR BOTH COLD & HOT POLYPECTOMY

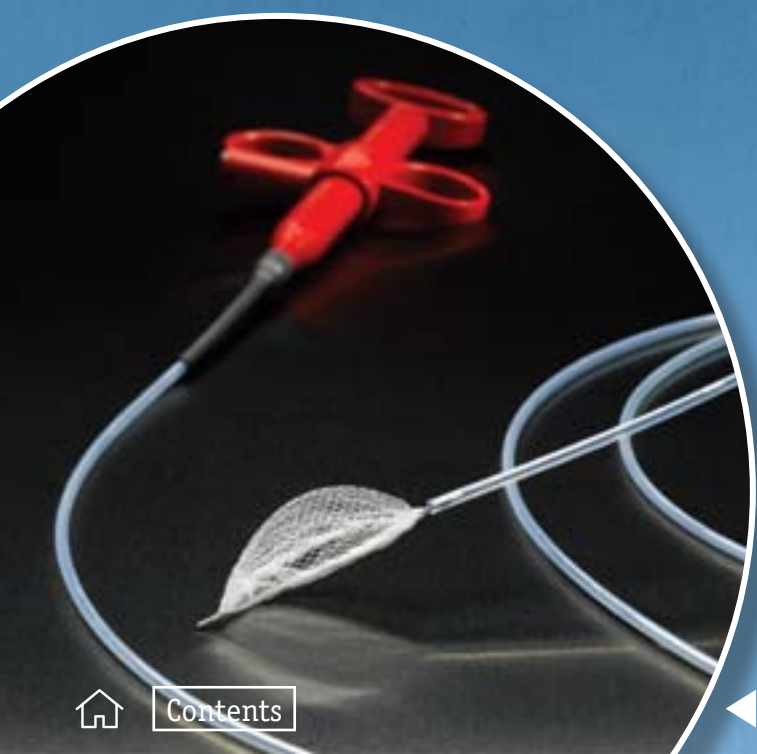

Contents

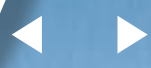

Alphabetical Index

Product Code Index

Polypectomy

SNARES

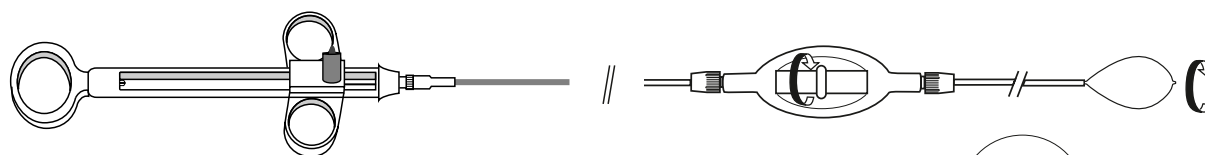

Star Catheter Technology

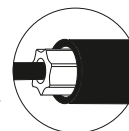

Rotatable Snares*

Order Number	Description	Stiffness	Loop Width (mm)	Sheath O.D. (mm)	Working Length (cm)	Minimum Working Channel (mm)	Units
M00561821	Small Oval	Medium Stiff	13	2.4	195	2.8	box 10
M00561831	Medium Oval	Medium Stiff	20	2.4	195	2.8	box 10

*With Star Catheter Technology.

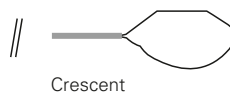
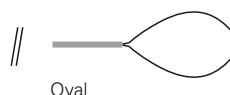
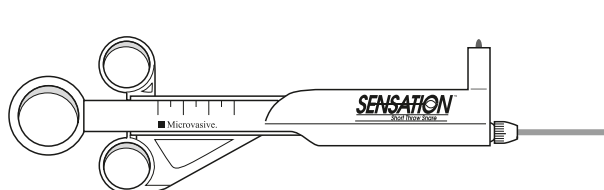

Sensation™ Short Throw Snares

Order Number	Description	Stiffness	Loop Width (mm)	Sheath O.D. (mm)	Working Length (cm)	Minimum Working Channel (mm)	Units
M00562691	Small Oval	Flexible	13	2.4	240	2.8	box 5
M00562692	Small Oval	Flexible	13	2.4	240	2.8	box 20
M00562693	Small Oval	Flexible	13	2.4	240	2.8	box 40
M00560321	Small Oval	Medium Stiff	13	2.4	240	2.8	box 5
M00562671	Medium Oval	Flexible	27	2.4	240	2.8	box 5
M00562672	Medium Oval	Flexible	27	2.4	240	2.8	box 20
M00562673	Medium Oval	Flexible	27	2.4	240	2.8	box 40
M00560311	Medium Oval	Medium Stiff	27	2.4	240	2.8	box 5
M00562651	Large Oval	Medium Stiff	30	2.4	240	2.8	box 5
M00562652	Large Oval	Medium Stiff	30	2.4	240	2.8	box 20
M00560331	Medium Crescent	Medium Stiff	27	2.4	240	2.8	box 5

Polypectomy

SNARES (CONTINUED)

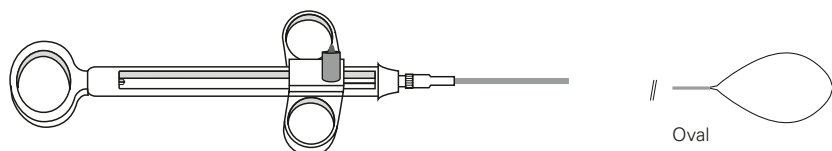

Captiflex™ Snares



Order Number	Description	Stiffness	Loop Width (mm)	Sheath O.D. (mm)	Working Length (cm)	Minimum Working Channel (mm)	Units
M00562471	Extra Small Oval	Flexible	11	2.4	240	2.8	box 10
M00562421	Small Oval	Flexible	13	2.4	240	2.8	box 10
M00562422	Small Oval	Flexible	13	2.4	240	2.8	box 40
M00562401	Medium Oval	Flexible	27	2.4	240	2.8	box 10
M00562402	Medium Oval	Flexible	27	2.4	240	2.8	box 40

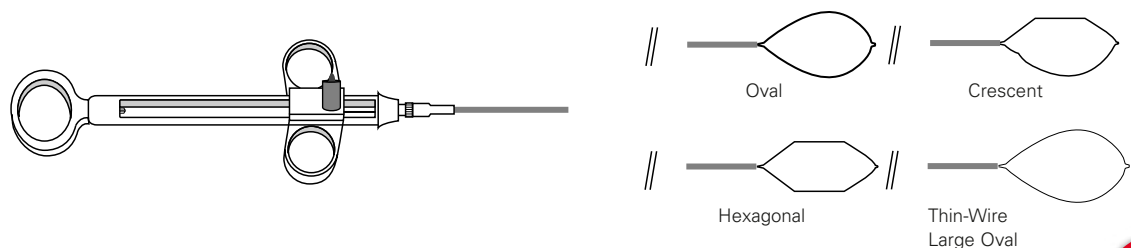

Captivator™ Snares



Order Number	Description	Stiffness	Loop Width (mm)	Sheath O.D. (mm)	Working Length (cm)	Minimum Working Channel (mm)	Units
M00562301	Small Oval	Stiff	13	2.4	240	2.8	box 10
M00562321	Medium Oval	Stiff	27	2.4	240	2.8	box 10
M00562391	Large Oval (thin wire)	Flexible	30	2.4	240	2.8	box 10
M00561311	Large Oval	Medium Stiff	30	2.4	240	2.8	box 10
M00562451	Small Hexagonal	Stiff	13	2.4	240	2.8	box 10
M00562341	Medium Hexagonal	Stiff	27	2.4	240	2.8	box 10
M00562371	Medium Crescent	Stiff	27	2.4	240	2.8	box 10

Polypectomy

SNARES (CONTINUED)

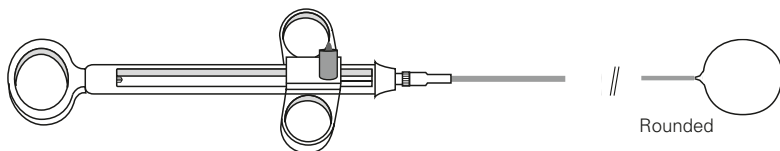

Captivator™ II Snares



NEW

Order Number	Description	Stiffness	Loop Width (mm)	Sheath O.D. (mm)	Working Length (cm)	Minimum Working Channel (mm)	Units
M00561221	10 mm Rounded	Stiff	10	2.4	240	2.8	box 10
M00561222	10 mm Rounded	Stiff	10	2.4	240	2.8	box 20
M00561223	10 mm Rounded	Stiff	10	2.4	240	2.8	box 40
M00561231	15 mm Rounded	Stiff	15	2.4	240	2.8	box 10
M00561232	15 mm Rounded	Stiff	15	2.4	240	2.8	box 20
M00561233	15 mm Rounded	Stiff	15	2.4	240	2.8	box 40
M00561241	20 mm Rounded	Stiff	20	2.4	240	2.8	box 10
M00561242	20 mm Rounded	Stiff	20	2.4	240	2.8	box 20
M00561243	20 mm Rounded	Stiff	20	2.4	240	2.8	box 40
M00561191	25 mm Rounded	Stiff	25	2.4	240	2.8	box 10
M00561192	25 mm Rounded	Stiff	25	2.4	240	2.8	box 20
M00561193	25 mm Rounded	Stiff	25	2.4	240	2.8	box 40
M00561291	33 mm Rounded	Stiff	33	2.4	240	2.8	box 10

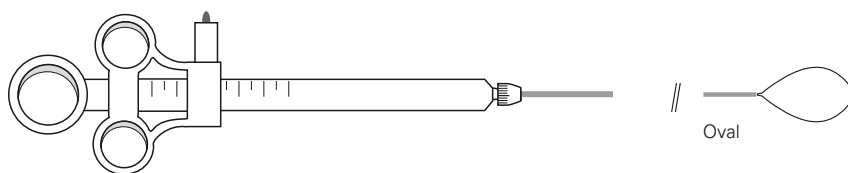

Profile™ Pediatric Snares



Order Number	Description	Stiffness	Loop Width (mm)	Sheath O.D. (mm)	Working Length (cm)	Minimum Working Channel (mm)	Units
M00562531	Extra Small Oval	Flexible	11	1.9	240	2.0	box 10
M00562551	Small Oval	Flexible	13	1.9	240	2.0	box 10
M00562571	Medium Oval	Flexible	27	1.9	240	2.0	box 10

Polypectomy

HOT BIOPSY FORCEPS

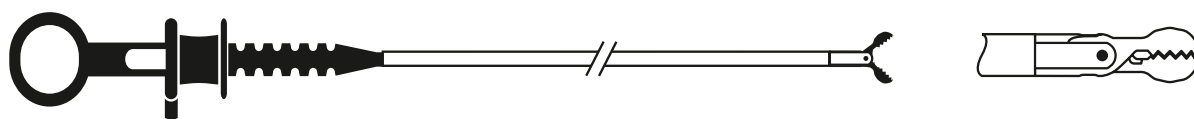

Radial Jaw™ 4 Hot Biopsy Forceps



Order Number	Description	Jaw O.D. (mm)	Working Length (cm)	Minimum Working Channel (mm)	Units
M00515031	Radial Jaw 4 Hot Biopsy Forceps	2.2	240	2.8	box 5
M00515032	Radial Jaw 4 Hot Biopsy Forceps	2.2	240	2.8	box 20
M00515033	Radial Jaw 4 Hot Biopsy Forceps	2.2	240	2.8	box 40

POLYP RETRIEVAL DEVICE

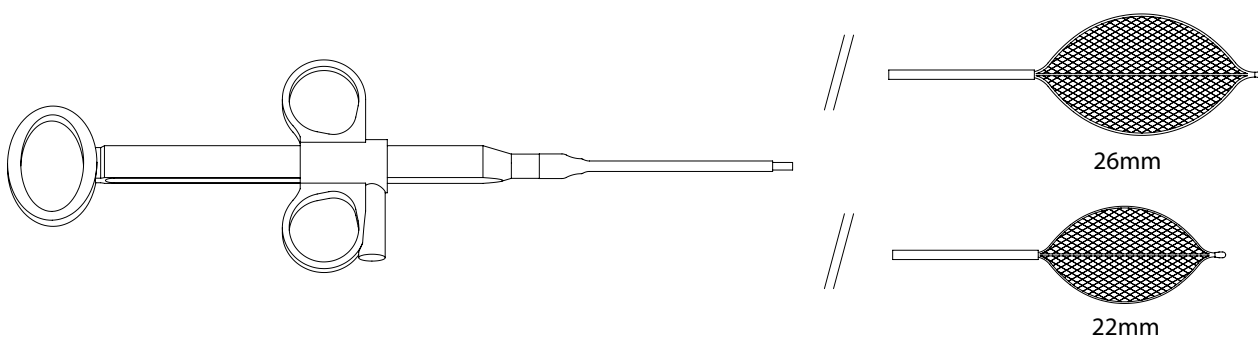

TWISTER® PLUS Rotatable Retrieval Device



Order Number	Description	Loop Width (mm)	Sheath O.D. (mm)	Working Length (cm)	Minimum Working Channel (mm)	Units
M00561411	TWISTER PLUS Rotatable Retrieval Device	22	2.5	230	2.8	box 5
M00561412	TWISTER PLUS Rotatable Retrieval Device	22	2.5	230	2.8	box 10
M00561421	TWISTER PLUS Rotatable Retrieval Device	26	2.5	230	2.8	box 5
M00561422	TWISTER PLUS Rotatable Retrieval Device	26	2.5	230	2.8	box 10

TWISTER® PLUS is a trademark of Horizons International Corp.
 Distributed by Boston Scientific Corporation, Natick, Massachusetts; manufactured by Horizons International Corp., Heredia, Costa Rica.

Active Cords

Order Number	Description	Units
M00561250	Active Cord, Fits Olympus® Brand Generator	box 1
M00561270	Active Cord, Fits Endostat™, Endostat™ II, Bovie®, ValleyLab®, Aspen Labs and ERBE® Brand Generators	box 1



Biopsy

FORCEPS

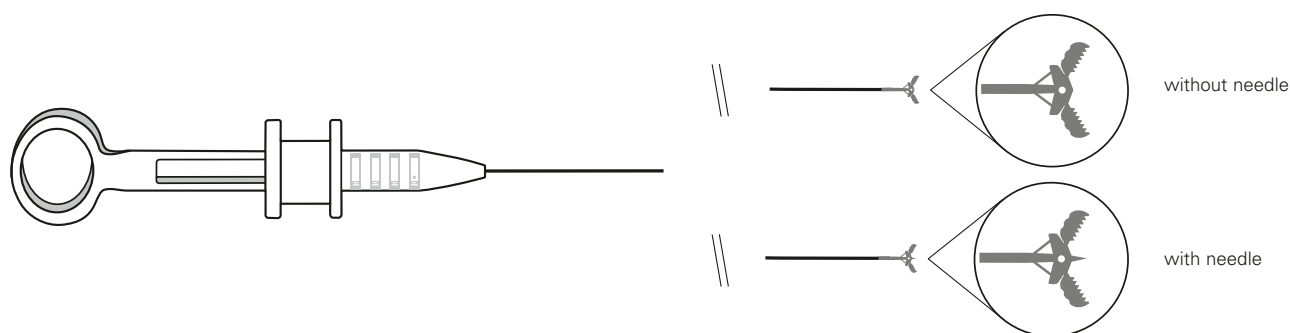

Radial Jaw™ 4 Standard Capacity Biopsy Forceps



Order Number	Description	Jaw O.D. (mm)	Working Length (cm)	Minimum Working Channel (mm)	Colour Code	Units
M00513383	Radial Jaw 4 Standard Capacity	2.2	160	2.8	Yellow	box 5
M00513381	Radial Jaw 4 Standard Capacity	2.2	160	2.8	Yellow	box 20
M00513382	Radial Jaw 4 Standard Capacity	2.2	160	2.8	Yellow	box 40
M00513393	Radial Jaw 4 Standard Capacity w/Needle	2.2	160	2.8	Yellow	box 5
M00513391	Radial Jaw 4 Standard Capacity w/Needle	2.2	160	2.8	Yellow	box 20
M00513392	Radial Jaw 4 Standard Capacity w/Needle	2.2	160	2.8	Yellow	box 40
M00513403	Radial Jaw 4 Standard Capacity	2.2	240	2.8	Orange	box 5
M00513401	Radial Jaw 4 Standard Capacity	2.2	240	2.8	Orange	box 20
M00513402	Radial Jaw 4 Standard Capacity	2.2	240	2.8	Orange	box 40
M00513413	Radial Jaw 4 Standard Capacity w/Needle	2.2	240	2.8	Orange	box 5
M00513411	Radial Jaw 4 Standard Capacity w/Needle	2.2	240	2.8	Orange	box 20
M00513412	Radial Jaw 4 Standard Capacity w/Needle	2.2	240	2.8	Orange	box 40

Radial Jaw™ 4 Large Capacity Biopsy Forceps



Order Number	Description	Jaw O.D. (mm)	Working Length (cm)	Minimum Working Channel (mm)	Colour Code	Units
M00513303	Radial Jaw 4 Large Capacity	2.4	160	2.8	Yellow	box 5
M00513301	Radial Jaw 4 Large Capacity	2.4	160	2.8	Yellow	box 20
M00513302	Radial Jaw 4 Large Capacity	2.4	160	2.8	Yellow	box 40
M00513313	Radial Jaw 4 Large Capacity w/Needle	2.4	160	2.8	Yellow	box 5
M00513311	Radial Jaw 4 Large Capacity w/Needle	2.4	160	2.8	Yellow	box 20
M00513312	Radial Jaw 4 Large Capacity w/Needle	2.4	160	2.8	Yellow	box 40
M00513323	Radial Jaw 4 Large Capacity	2.4	240	2.8	Orange	box 5
M00513321	Radial Jaw 4 Large Capacity	2.4	240	2.8	Orange	box 20
M00513322	Radial Jaw 4 Large Capacity	2.4	240	2.8	Orange	box 40
M00513333	Radial Jaw 4 Large Capacity w/Needle	2.4	240	2.8	Orange	box 5
M00513331	Radial Jaw 4 Large Capacity w/Needle	2.4	240	2.8	Orange	box 20
M00513332	Radial Jaw 4 Large Capacity w/Needle	2.4	240	2.8	Orange	box 40

Biopsy

FORCEPS (CONTINUED)

Radial Jaw™ 4 Jumbo Biopsy Forceps



Order Number	Description	Jaw O.D. (mm)	Working Length (cm)	Minimum Working Channel (mm)	Colour Code	Units
M00513343	Radial Jaw 4 Jumbo	2.8	160	3.2	Yellow	box 5
M00513353	Radial Jaw 4 Jumbo w/Needle	2.8	160	3.2	Yellow	box 5
M00513363	Radial Jaw 4 Jumbo	2.8	240	3.2	Orange	box 5
M00513361	Radial Jaw 4 Jumbo	2.8	240	3.2	Orange	box 20
M00513362	Radial Jaw 4 Jumbo	2.8	240	3.2	Orange	box 40
M00513373	Radial Jaw 4 Jumbo w/Needle	2.8	240	3.2	Orange	box 5
M00513371	Radial Jaw 4 Jumbo w/Needle	2.8	240	3.2	Orange	box 20
M00513372	Radial Jaw 4 Jumbo w/Needle	2.8	240	3.2	Orange	box 40

Radial Jaw™ 4 Gastropediatric Biopsy Forceps



Order Number	Description	Jaw O.D. (mm)	Working Length (cm)	Minimum Working Channel (mm)	Colour Code	Units
M00513443	Radial Jaw 4 Gastropediatric	1.8	160	2.0	Yellow	box 5
M00513441	Radial Jaw 4 Gastropediatric	1.8	160	2.0	Yellow	box 20
M00513453	Radial Jaw 4 Gastropediatric w/Needle	1.8	160	2.0	Yellow	box 5
M00513451	Radial Jaw 4 Gastropediatric w/Needle	1.8	160	2.0	Yellow	box 20

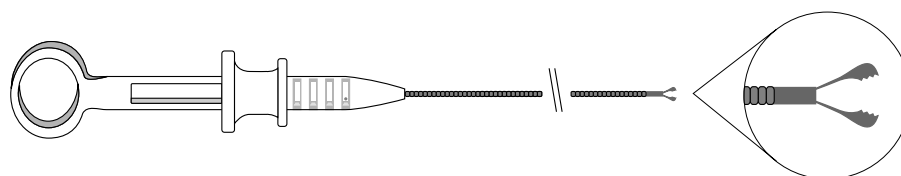

Multibite™ Multiple Sample Biopsy Forceps



Order Number	Description	Jaw O.D. (mm)	Working Length (cm)	Minimum Working Channel (mm)	Colour Code	Units
M00510101	Multibite Multiple Sample Biopsy Forceps	2.4	160	2.8	Yellow	box 5
M00510121	Multibite Multiple Sample Biopsy Forceps	2.4	240	2.8	Orange	box 5

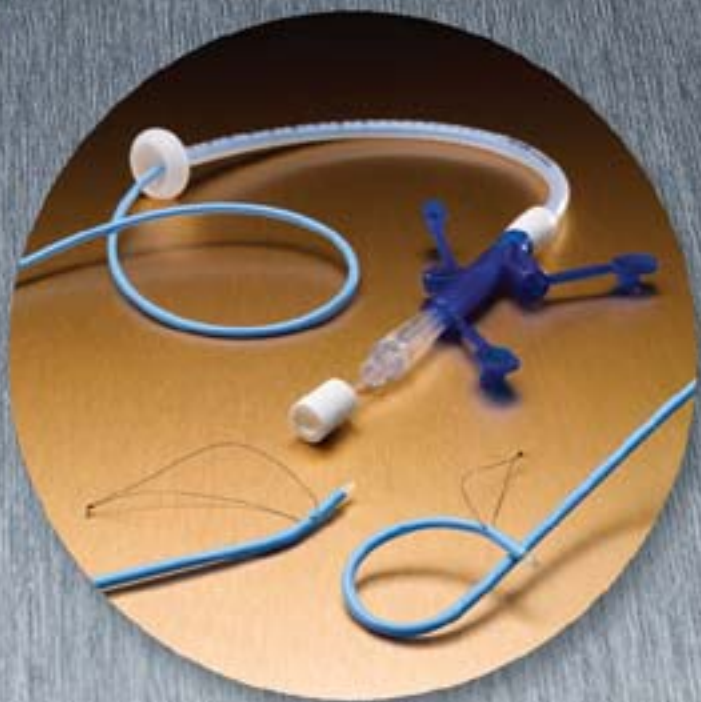

Enteral Feeding

PERCUTANEOUS ENDOSCOPIC GASTROSTOMY (PEG) DEVICES

Initial Placement



Standard PEGs

Order Number	Description	Units
M00568381	20F (6.67mm) Standard PEG Kit, Pull	box 2
M00568391	24F (8.00mm) Standard PEG Kit, Pull	box 2
M00568401	20F (6.67mm) Standard PEG Kit, Push	box 2
M00568411	24F (8.00mm) Standard PEG Kit, Push	box 2

PEG/Replacement PEG Accessories

Order Number	Description	Units
M00580641	20F (6.67mm) Y-Ports	box 10
M00580651	24F (8.00mm) Y-Port	box 10
M00580731	20F (6.67mm) Round Bolsters	box 10
M00580781	20F (6.67mm) and 24F (8.00mm) C-Clamps	box 10

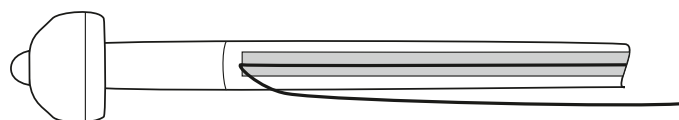

One Step Button Low Profile PEG Kits

Order Number	Description	Length (cm)	Units
M00568450	18F (6.00mm) One Step Button Kit, Pull	1.7	box 1
M00568460	18F (6.00mm) One Step Button Kit, Pull	2.4	box 1
M00568470	18F (6.00mm) One Step Button Kit, Pull	3.4	box 1
M00568480	18F (6.00mm) One Step Button Kit, Pull	4.4	box 1
M00568500	24F (8.00mm) One Step Button Kit, Pull	1.7	box 1
M00568510	24F (8.00mm) One Step Button Kit, Pull	2.4	box 1
M00568520	24F (8.00mm) One Step Button Kit, Pull	3.4	box 1
M00568530	24F (8.00mm) One Step Button Kit, Pull	4.4	box 1
M00568560	18F (6.00mm) One Step Button Kit, Push	2.4	box 1
M00568570	18F (6.00mm) One Step Button Kit, Push	3.4	box 1
M00568580	18F (6.00mm) One Step Button Kit, Push	4.4	box 1
M00568600	24F (8.00mm) One Step Button Kit, Push	1.7	box 1
M00568610	24F (8.00mm) One Step Button Kit, Push	2.4	box 1
M00568620	24F (8.00mm) One Step Button Kit, Push	3.4	box 1
M00568630	24F (8.00mm) One Step Button Kit, Push	4.4	box 1

Enteral Feeding

PERCUTANEOUS ENDOSCOPIC GASTROSTOMY (PEG) DEVICES (CONTINUED)

Initial Placement (CONTINUED)



One Step Button and Low Profile Button Accessories

Order Number	Description	Length (cm)	Colour Code	Units
M00580401	18F (6.00mm) Decompression Tube	1.2	Yellow	box 10
M00580411	18F (6.00mm) Decompression Tube	1.7	Yellow	box 10
M00580421	18F (6.00mm) Decompression Tube	2.4	Yellow	box 10
M00580431	18F (6.00mm) Decompression Tube	3.4	Yellow	box 10
M00580441	18F (6.00mm) Decompression Tube	4.4	Yellow	box 10
M00580461	24F (8.00mm) Decompression Tube	1.7	Blue	box 10
M00580471	24F (8.00mm) Decompression Tube	2.4	Blue	box 10
M00580481	24F (8.00mm) Decompression Tube	3.4	Blue	box 10
M00580491	24F (8.00mm) Decompression Tube	4.4	Blue	box 10
M00580171	18F (6.00mm) Bolus Straight Feeding Adapter		Yellow	box 10
M00580181	18F (6.00mm) Continuous Right Angle Feeding Adapter		Yellow	box 10
M00580231	24F (8.00mm) Bolus Straight Feeding Adapter		Blue	box 10
M00580241	24F (8.00mm) Continuous Right Angle Feeding Adapter		Blue	box 10
M00580271	28F (9.33mm) Bolus Straight Feeding Adapter		Green	box 10
M00580281	28F (9.33mm) Continuous Right Angle Feeding Adapter		Green	box 10

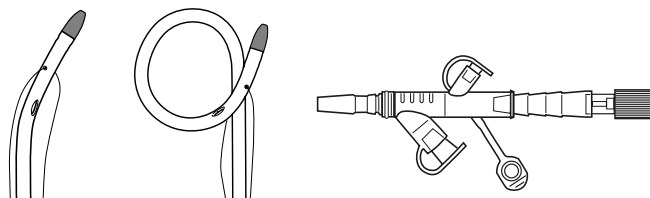

Through-The-PEG (TTP) Jejunal Feeding Tube

Order Number	Description	Tip Style	Units
M00566320	8.5F (2.83mm) TTP Jejunal Feeding Tube	Bent Tip	box 1
M00566330	8.5F (2.83mm) TTP Jejunal Feeding Tube	Pigtail Tip	box 1
M00566340	12F (4.00mm) TTP Jejunal Feeding Tube	Bent Tip	box 1
M00566350	12F (4.00mm) TTP Jejunal Feeding Tube	Pigtail Tip	box 1



Recommended Anchoring Device

Order Number	Description	Working Length (cm)	Minimum Working Channel (mm)	Clip Opening (mm)	Units
M00522610	Resolution™ Clip	235	2.8	11	box 1
M00522611	Resolution™ Clip	235	2.8	11	box 10
M00522612	Resolution™ Clip	235	2.8	11	box 20

Enteral Feeding

PERCUTANEOUS ENDOSCOPIC GASTROSTOMY (PEG) DEVICES (CONTINUED)

Replacements

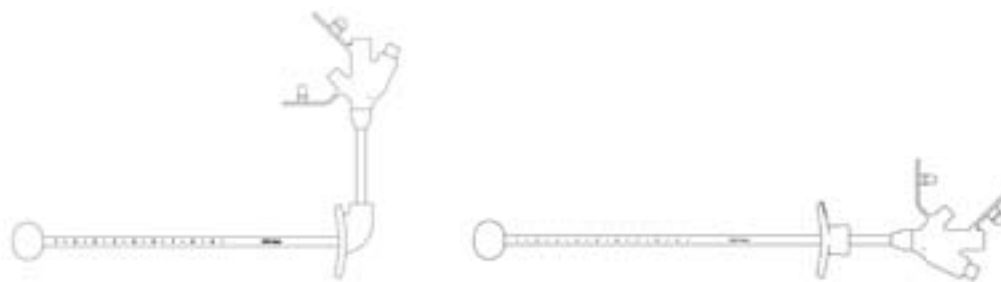

Standard Balloon Replacements

Order Number	Description	Units
M00582050	14F (4.67mm) Replacement G-Tube, Straight	box 1
M00582060	16F (5.33mm) Replacement G-Tube, Straight	box 1
M00582070	18F (6.00mm) Replacement G-Tube, Straight	box 1
M00582080	20F (6.67mm) Replacement G-Tube, Straight	box 1
M00582860	22F (7.33mm) Replacement G-Tube, Straight	box 1
M00582090	24F (8.00mm) Replacement G-Tube, Straight	box 1
M00582100	28F (9.33mm) Replacement G-Tube, Straight	box 1
M00582120	14F (4.67mm) Replacement G-Tube, Right-Angle	box 1
M00582130	16F (5.33mm) Replacement G-Tube, Right-Angle	box 1
M00582140	18F (6.00mm) Replacement G-Tube, Right-Angle	box 1
M00582150	20F (6.67mm) Replacement G-Tube, Right-Angle	box 1
M00582870	22F (7.33mm) Replacement G-Tube, Right-Angle	box 1
M00582160	24F (8.00mm) Replacement G-Tube, Right-Angle	box 1
M00582170	28F (9.33mm) Replacement G-Tube, Right-Angle	box 1

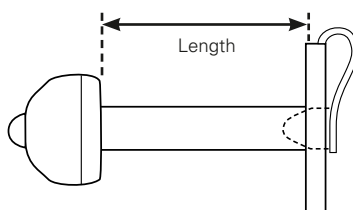

Low Profile Button Replacements

Order Number	Description	Length (cm)	Colour Code	Units
M00568260	18F (6.00mm) Low Profile Button Replacement	1.2	Yellow	box 1
M00568270	18F (6.00mm) Low Profile Button Replacement	1.7	Yellow	box 1
M00568280	18F (6.00mm) Low Profile Button Replacement	2.4	Yellow	box 1
M00568290	18F (6.00mm) Low Profile Button Replacement	3.4	Yellow	box 1
M00568300	18F (6.00mm) Low Profile Button Replacement	4.4	Yellow	box 1
M00568320	24F (8.00mm) Low Profile Button Replacement	1.7	Blue	box 1
M00568330	24F (8.00mm) Low Profile Button Replacement	2.4	Blue	box 1
M00568340	24F (8.00mm) Low Profile Button Replacement	3.4	Blue	box 1
M00568350	24F (8.00mm) Low Profile Button Replacement	4.4	Blue	box 1
M00568170	28F (9.33mm) Low Profile Button Replacement	1.5	Green	box 1
M00568180	28F (9.33mm) Low Profile Button Replacement	2.8	Green	box 1
M00568190	28F (9.33mm) Low Profile Button Replacement	4.3	Green	box 1

For accessories please refer to the One-Step Button and Low Profile Button Accessories





Pulmonary

ALAIR™ BRONCHIAL THERMOPLASTY (BT) SYSTEM

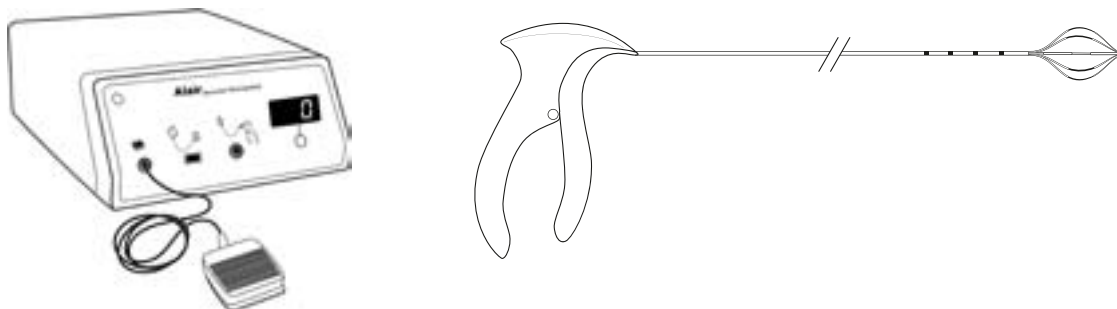

Alair™ Bronchial Thermoplasty (BT) System

Order Number	Model	Description	Active Electrode Length (mm)	Tip Diameter (mm)	Minimum Working Channel (mm)
M005ATS25020	ATS 2-5	Alair BT Catheter – Global	5.0	~1.5	2.0
M005ATS25010	ATS 2-5	Alair BT Catheter – North America	5.0	~1.5	2.0
M005ATS20000	ATS 200	Alair RF Controller – monopolar (return electrode not included)			

Packaged one per box

Alair™ BT Controller Accessory Kits ATS 201*

Order Number	Model	Description
M005ATS20110	ATS 201	North American Plug
M005ATS20120	ATS 201	British Type G
M005ATS20130	ATS 201	EU Hybrid Type E/F
M005ATS20140	ATS 201	Australian Type I
M005ATS20150	ATS 201	Danish Type K
M005ATS20160	ATS 201	Brazil IEC 60906-1
M005ATS20170	ATS 201	Chinese CPCS-CCC (Chinese 10 A/250 V)
M005ATS20180	ATS 201	Swiss Type J
M005ATS20190	ATS 201	Israel Type H

Packaged one per box

* Including Power Cord with Molded Plug, Foot Switch, Operating Manual.

Pulmonary

AIRWAY STENTS

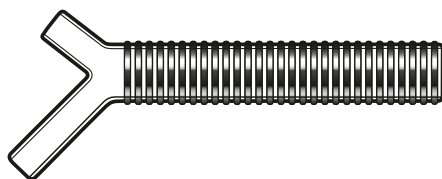

Dynamic™ (Y) Stents



Order Number	Description	Tracheal Width (Internal) (mm)	Bronchial Width (Internal) (mm)	Tracheal Length (mm)	Bronchial Lengths (Right/Left) (mm)
M00570670	Dynamic (Y) Stent	11	8	110	25 / 40
M00570680	Dynamic (Y) Stent	13	10	110	25 / 40
M00570690	Dynamic (Y) Stent	15	12	110	25 / 40

Packaged one per box

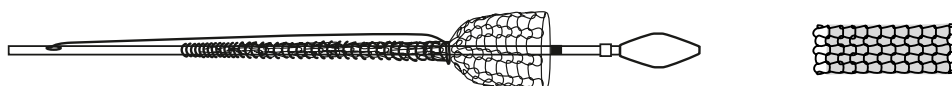

Ultraflex™ Covered Tracheobronchial NG Stents – Distal Release

Tracheal Stents



Order Number	Description	Maximum Stent O.D. (mm)	Expanded Stent Length (mm)	Covered Length (mm)
M00564820	Ultraflex Tracheal NG Stent	14	80	65
M00564830	Ultraflex Tracheal NG Stent	16	40	25
M00564840	Ultraflex Tracheal NG Stent	16	60	45
M00564850	Ultraflex Tracheal NG Stent	16	80	65
M00564860	Ultraflex Tracheal NG Stent	18	40	25
M00564870	Ultraflex Tracheal NG Stent	18	60	45
M00564880	Ultraflex Tracheal NG Stent	18	80	65
M00564890	Ultraflex Tracheal NG Stent	20	40	25
M00564900	Ultraflex Tracheal NG Stent	20	60	45
M00564910	Ultraflex Tracheal NG Stent	20	80	65

Bronchial Stents

Order Number	Description	Maximum Stent O.D. (mm)	Expanded Stent Length (mm)	Covered Length (mm)
M00564740	Ultraflex Bronchial NG Stent	8	40	25
M00564750	Ultraflex Bronchial NG Stent	10	30	15
M00564760	Ultraflex Bronchial NG Stent	10	40	25
M00564770	Ultraflex Bronchial NG Stent	12	30	15
M00564780	Ultraflex Bronchial NG Stent	12	40	25
M00564790	Ultraflex Bronchial NG Stent	14	30	15
M00564800	Ultraflex Bronchial NG Stent	14	40	25
M00564810	Ultraflex Bronchial NG Stent	14	60	45

Packaged one per box

Recommended Guidewire: .035in (0.89mm) Jagwire™ Pulmonary Guidewire, M00515171

Additional Specifications for Ultraflex Tracheobronchial Stents: Delivery System Working Length is 95cm, Maximum Catheter Shaft O.D. is 16F (5.33mm), Compressed Stent on catheter yields Delivery System O.D. range 15-22F (5.00-7.33mm)



Pulmonary

AIRWAY STENTS (CONTINUED)



Ultraflex™ Non-covered Tracheobronchial NG Stents – Proximal Release

Tracheal Stents

Order Number	Description	Maximum Stent O.D. (mm)	Expanded Stent Length (mm)
M00564710	Ultraflex Tracheal NG Stent	14	40
M00564720	Ultraflex Tracheal NG Stent	14	60

Bronchial Stents

Order Number	Description	Maximum Stent O.D. (mm)	Expanded Stent Length (mm)
M00564640	Ultraflex Bronchial NG Stent	8	20
M00564650	Ultraflex Bronchial NG Stent	8	40
M00564660	Ultraflex Bronchial NG Stent	10	20
M00564670	Ultraflex Bronchial NG Stent	10	40
M00564680	Ultraflex Bronchial NG Stent	12	20
M00564690	Ultraflex Bronchial NG Stent	12	40
M00564700	Ultraflex Bronchial NG Stent	14	20

Packaged one per box

Recommended Guidewire: .035in (0.89mm) Jagwire™ Pulmonary Guidewire, M00515171

Additional Specifications for Ultraflex Tracheobronchial Stents: Delivery System Working Length is 95cm, Maximum Catheter Shaft O.D. is 16F (5.33mm), Compressed Stent on catheter yields Delivery System O.D. range 15-22F (5.00-7.33mm)

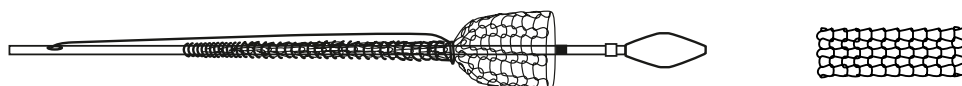

Ultraflex™ Non-covered Tracheobronchial NG Stents – Distal Release

Tracheal Stents

Order Number	Description	Maximum Stent O.D. (mm)	Expanded Stent Length (mm)
M00564530	Ultraflex Tracheal NG Stent	16	40
M00564540	Ultraflex Tracheal NG Stent	16	60
M00564560	Ultraflex Tracheal NG Stent	18	40
M00564570	Ultraflex Tracheal NG Stent	18	60
M00564590	Ultraflex Tracheal NG Stent	20	40
M00564600	Ultraflex Tracheal NG Stent	20	60

Bronchial Stents

Order Number	Description	Maximum Stent O.D. (mm)	Expanded Stent Length (mm)
M00564500	Ultraflex Bronchial NG Stent	10	30
M00564510	Ultraflex Bronchial NG Stent	12	30
M00564520	Ultraflex Bronchial NG Stent	14	30

Packaged one per box

Recommended Guidewire: .035in (0.89mm) Jagwire™ Pulmonary Guidewire, M00515171

Additional Specifications for Ultraflex Tracheobronchial Stents: Delivery System Working Length is 95cm, Maximum Catheter Shaft O.D. is 16F (5.33mm), Compressed Stent on catheter yields Delivery System O.D. range 15-22F (5.00-7.33mm)

Pulmonary

AIRWAY STENTS (CONTINUED)



Polyflex Stent™ Self-expanding Silicone Airway Stents



Order Number	Description	Stent I.D. (mm)	Stent Length (mm)	Delivery System Diameter (mm)
M00570000	Polyflex Airway Stent	8	20	7
M00570010	Polyflex Airway Stent	8	30	7
M00570020	Polyflex Airway Stent	10	20	8
M00570030	Polyflex Airway Stent	10	30	8
M00570040	Polyflex Airway Stent	10	40	8
M00570050	Polyflex Airway Stent	10	50	8
M00570060	Polyflex Airway Stent	12	20	9
M00570070	Polyflex Airway Stent	12	30	9
M00570080	Polyflex Airway Stent	12	40	9
M00570090	Polyflex Airway Stent	12	50	9
M00570100	Polyflex Airway Stent	14	20	9
M00570110	Polyflex Airway Stent	14	30	9
M00570120	Polyflex Airway Stent	14	40	9
M00570130	Polyflex Airway Stent	14	50	9
M00570140	Polyflex Airway Stent	14	60	9
M00570150	Polyflex Airway Stent	16	30	10
M00570160	Polyflex Airway Stent	16	40	10
M00570170	Polyflex Airway Stent	16	50	10
M00570180	Polyflex Airway Stent	16	60	10
M00570190	Polyflex Airway Stent	16	70	10
M00570200	Polyflex Airway Stent	18	30	11
M00570210	Polyflex Airway Stent	18	40	11
M00570220	Polyflex Airway Stent	18	50	11
M00570230	Polyflex Airway Stent	18	60	11
M00570240	Polyflex Airway Stent	18	70	11
M00570250	Polyflex Airway Stent	18	80	11
M00570260	Polyflex Airway Stent	20	40	12
M00570270	Polyflex Airway Stent	20	50	12
M00570280	Polyflex Airway Stent	20	60	12
M00570290	Polyflex Airway Stent	20	70	12
M00570300	Polyflex Airway Stent	20	80	12
M00570310	Polyflex Airway Stent	22	50	13
M00570320	Polyflex Airway Stent	22	60	13
M00570330	Polyflex Airway Stent	22	80	13

Packaged one per box



Contents

Alphabetical Index

Product Code Index

Pulmonary

BIOPSY FORCEPS

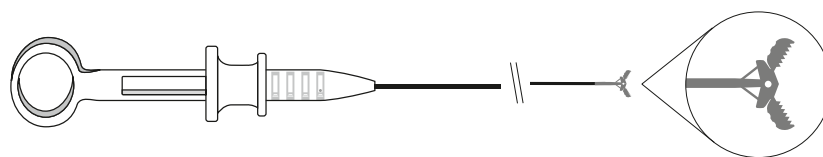

Radial Jaw™ 4 Pulmonary Biopsy Forceps



Order Number	Description	Jaw O.D. (mm)	Working Length (cm)	Minimum Working Channel (mm)	Colour Code	Units
M00515181	Radial Jaw 4 Standard Capacity	1.8	100	2.0	Blue	box 5
M00515182	Radial Jaw 4 Standard Capacity	1.8	100	2.0	Blue	box 20
M00515191	Radial Jaw 4 Standard Capacity w/Needle	1.8	100	2.0	Blue	box 5
M00515192	Radial Jaw 4 Standard Capacity w/Needle	1.8	100	2.0	Blue	box 20
M00515201	Radial Jaw 4 Large Capacity	2.2	100	2.8	Blue	box 5
M00515202	Radial Jaw 4 Large Capacity	2.2	100	2.8	Blue	box 20

TRANSBRONCHIAL ASPIRATION NEEDLES

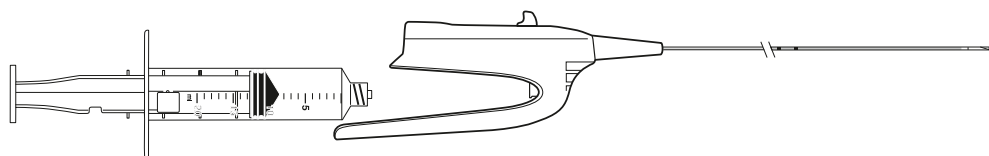

eXcelon™ Transbronchial Aspiration Needle with Syringe



Order Number	Description	Needle			Needle Length (mm)	Catheter Length (cm)	Sheath O.D. (mm)	Units
		Gauge	O.D. (mm)	I.D. (mm)				
M00564101	eXcelon Transbronchial Aspiration Needle w/Syringe	19	1.07	0.69	15	130	1.8	box 5
M00564111	eXcelon Transbronchial Aspiration Needle w/Syringe	20	0.90	0.58	15	130	1.8	box 5
M00564121	eXcelon Transbronchial Aspiration Needle w/Syringe	21	0.81	0.50	15	130	1.8	box 5

CYTOLOGY BRUSHES

Celebrity™ Endoscopic Cytology Brushes – Bronchoscope



Order Number	Description	Required Working Channel (mm)	Bristle O.D. (mm)	Sheath Length (cm)	Units
M00516001	Celebrity Cytology Brush	2.0	1.0	140	box 10
M00516011	Celebrity Cytology Brush	2.0	1.5	140	box 10
M00516071	Celebrity Cytology Brush	2.0	1.9	100	box 10
M00516151	Celebrity Cytology Brush	2.0	1.9	150	box 10

Pulmonary

AIRWAY RETRIEVAL BASKETS

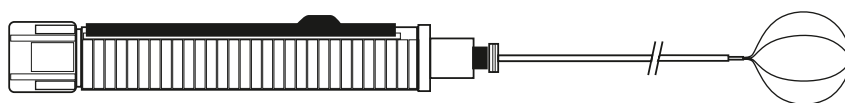

ZeroTip™ Airway Retrieval Baskets



Order Number	Description	Sheath O.D. (mm)	Working Length (cm)	Basket Opening (mm)	Sheath Material
M00513200	ZeroTip Airway Retrieval Basket	0.8	120	12	Polyimide/PTFE
M00513210	ZeroTip Airway Retrieval Basket	1.0	120	16	Polyimide/PTFE

Packaged one per box

DILATION BALLOONS



CRE™ Pulmonary Dilation Balloons



Order Number	Description	Balloon Length (cm)	Initial Balloon O.D. (mm)	Intermediate Balloon O.D. (mm)	Maximum Balloon O.D. (mm)	Working Catheter Length (cm)
M00550300	CRE Balloon	5.5	12	13.5	15	75
M00550310	CRE Balloon	5.5	15	16.5	18	75
M00550320	CRE Balloon	5.5	18	19.0	20	75
M00550330	CRE Balloon	3.0	8	9.0	10	75
M00550340	CRE Balloon	3.0	10	11.0	12	75
M00550350	CRE Balloon	3.0	12	13.5	15	75

Packaged one per box

GUIDEWIRES

Jagwire™ Pulmonary Guidewire



Order Number	Description	O.D. (in) / (mm)	Length (cm)	Units
M00515171	Jagwire	.035 / 0.89	180	box 2

Pulmonary

INFLATION SYSTEM

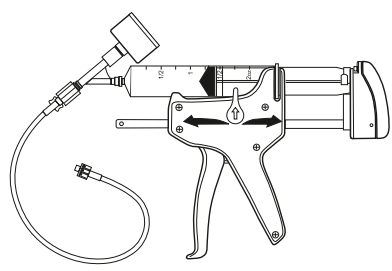

Alliance™ II Inflation System

Order Number	Description	Units
M00550620	Alliance™ II Inflation Handle	box 1
M00550601	⊗ 60ml Syringe/Gauge Assembly	box 5



Find more information on Boston Scientific products
by using your smartphone to scan this code or visit

[http://www.bostonscientific.com/en-EU/
medical-specialties/gastroenterology.html](http://www.bostonscientific.com/en-EU/medical-specialties/gastroenterology.html)

**Boston
Scientific**
Advancing science for life™

Boston Scientific International SA
Parc Val Saint Quentin - Bâtiment H
78960 Voisins-le-Bretonneux – France
+33 1 39 30 97 00

All cited trademarks are the property of their respective owners. CAUTION: The law restricts these devices to sale by or on the order of a physician. Indications, contraindications, warnings and instructions for use can be found in the product labelling supplied with each device. Information for the use only in countries with applicable health authority product registrations.

ENDO-294301-AB February 2015 Printed in Germany by medicalvision.

© 2015 Boston Scientific Corporation
or its affiliates. All rights reserved.
DINEND2341EB

