

Biliary Access

Biliary Access

Guidewires

Dreamwire™ High Performance Guidewire	3
Hydra Jagwire™ High Performance Guidewire	3
Jagwire™ High Performance Guidewire	4
NaviPro™ Hydrophilic Guidewire	5
Pathfinder™ Exchange Guidewire	5

RX Preloaded Sphincterotome

Dreamtome™ RX Cannulating Sphincterotome (Preloaded with Dreamwire High Performance Guidewire)	6
Hydratome™ RX Cannulating Sphincterotome (Preloaded with Hydra Jagwire Guidewire)	6
Jagtome™ RX Cannulating Sphincterotome (Preloaded with Jagwire Guidewire)	7

RX Sphincterotome

Autotome™ RX Cannulating Sphincterotome	8
RX Cholangiogram Kits	8
RX Needle Knife XL Triple-Lumen Needle Knife	8
Ultratome™ RX Cannulating Sphincterotome	8

Sphincterotome

MicroKnife™ XL Triple-Lumen Needle Knife	9
Stonetome™ Stone Removal Device	10
TRUEtome™ Cannulating Sphincterotome	9
Ultratome Double-Lumen Sphincterotome	11
Ultratome XL Triple-Lumen Sphincterotome	10



RX Cannulas

Rapid Exchange XL Cannula	11
RX ERCP Cannulas	11

Cannulas

Contour™ ERCP Cannulas	12
Fluoro Tip™ ERCP Cannulas	12
Tandem™ XL Triple-Lumen ERCP Cannula	12

Accessories

Active Cords (Fits Boston Scientific Endoscopy Sphincterotome)	13
RX Locking Devices and Biopsy Cap Systems	13

Rapid Refill Continuous Injection System

Rapid Refill Continuous Injection System	13
--	----

Biliary

Guidewires

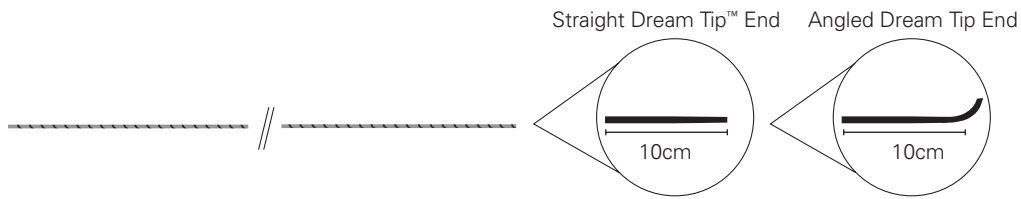

Dreamwire™ High Performance Guidewire



Order Number	Description	Distal Tip O.D. (in)	Working Length (cm)	Dream Tip Style	Tip	Packaging
M00556101	Dreamwire ST Guidewire	.035	260	Straight	Round	Box 2
M00556111	Dreamwire ANG Guidewire	.035	260	Angled	Round	Box 2
M00556121	Dreamwire ST Stiff Guidewire	.035	260	Straight	Round	Box 2
M00556131	Dreamwire ANG Stiff Guidewire	.035	260	Angled	Round	Box 2
M00556141	Dreamwire ST Guidewire	.035	450	Straight	Round	Box 2
M00556151	Dreamwire ANG Guidewire	.035	450	Angled	Round	Box 2
M00556161	Dreamwire ST Stiff Guidewire	.035	450	Straight	Round	Box 2
M00556171	Dreamwire ANG Stiff Guidewire	.035	450	Angled	Round	Box 2

ST = Standard, ANG = Angled

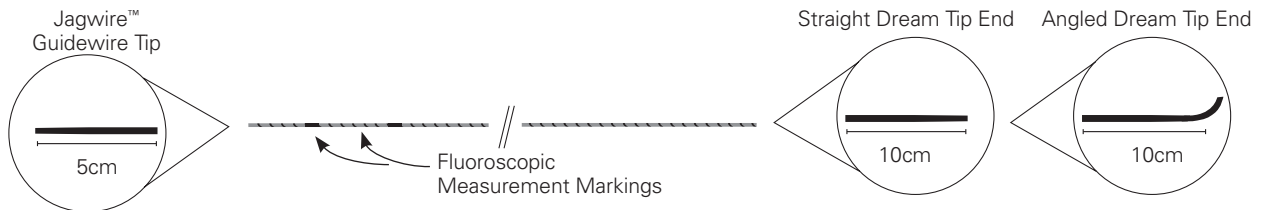

Hydra Jagwire™ High Performance Guidewire



Order Number	Description	Distal Tip O.D. (in)	Working Length (cm)	Dream Tip Style	Tip	Packaging
M00556001	Hydra Jagwire Guidewire ST	.035	260	Straight	Round	Box 2
M00556011	Hydra Jagwire Guidewire ANG	.035	260	Angled	Round	Box 2
M00556021	Hydra Jagwire Guidewire ST Stiff	.035	260	Straight	Round	Box 2
M00556031	Hydra Jagwire Guidewire ANG Stiff	.035	260	Angled	Round	Box 2
M00556041	Hydra Jagwire Guidewire ST	.035	450	Straight	Round	Box 2
M00556051	Hydra Jagwire Guidewire ANG	.035	450	Angled	Round	Box 2
M00556061	Hydra Jagwire Guidewire ST Stiff	.035	450	Straight	Round	Box 2
M00556071	Hydra Jagwire Guidewire ANG Stiff	.035	450	Angled	Round	Box 2

Hydra Jagwire Guidewire may remain in place during sphincterotomy. See Instructions for Use for details.

ST = Standard, ANG = Angled

Biliary

Guidewires (Continued)

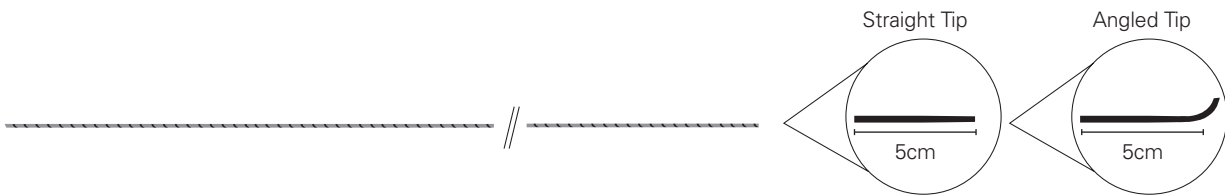

Jagwire™ High Performance Guidewire



Order Number	Description	Distal Tip O.D. (in)	Working Length (cm)	Tip Style	Tip	Packaging
M00556561	Jagwire Guidewire ST	.025	450	Straight	Trim	Box 2
M00556581	Jagwire Guidewire ST	.035	450	Straight	Trim	Box 2
M00556591	Jagwire Guidewire ANG	.035	450	Angled	Trim	Box 2
M00556601	Jagwire Guidewire ST Stiff	.035	450	Straight	Trim	Box 2
M00556611	Jagwire Guidewire ANG Stiff	.035	450	Angled	Trim	Box 2
M00556621	Jagwire Guidewire ST	.038	260	Straight	Trim	Box 2
M00556631	Jagwire Guidewire ST Stiff	.035	260	Straight	Trim	Box 2
M00556641	Jagwire Guidewire ST	.035	260	Straight	Trim	Box 2
M00556651	Jagwire Guidewire ANG	.035	260	Angled	Trim	Box 2
M00556661	Jagwire Guidewire ANG Stiff	.035	260	Angled	Trim	Box 2
M00556461	Jagwire Guidewire ST	.025	260	Straight	Round	Box 2
M00556481	Jagwire Guidewire ST Stiff	.025	260	Straight	Round	Box 2
M00556491	Jagwire Guidewire ANG Stiff	.025	260	Angled	Round	Box 2
M00556841	Extendable Jagwire Guidewire ST	.035	260	Straight	Round	Box 2
M00556851	Extendable Jagwire Guidewire ANG	.035	260	Angled	Round	Box 2
M00556861	Extendable Jagwire Guidewire ST Stiff	.035	260	Straight	Round	Box 2
M00556871	Extendable Jagwire Guidewire ANG Stiff	.035	260	Angled	Round	Box 2
M00556902	Jagtail™ Guidewire Extension	.035	200	Guidewire extension		Box 5

Jagwire Guidewire may remain in place during sphincterotomy. See Instructions for Use for details.
ST = Standard, ANG = Angled

Biliary

Guidewires (Continued)

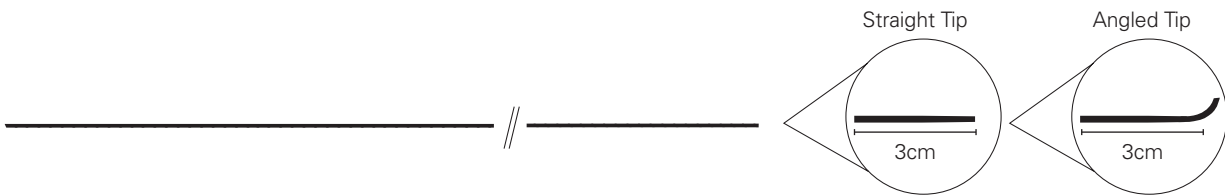

NaviPro™ Hydrophilic Guidewire

Order Number	Description	Guidewire Diameter (in)	Length (cm)	Tip Style	Packaging
M00556191	NaviPro Hydrophilic Guidewire	0.018	260	Angled	Box 5
M00556181	NaviPro Hydrophilic Guidewire	0.018	260	Straight	Box 5
M00556211	NaviPro Hydrophilic Guidewire	0.025	260	Angled	Box 5
M00556201	NaviPro Hydrophilic Guidewire	0.025	260	Straight	Box 5
M00556231	NaviPro Hydrophilic Guidewire	0.035	260	Angled	Box 5
M00556221	NaviPro Hydrophilic Guidewire	0.035	260	Straight	Box 5
M00556251	NaviPro Hydrophilic Guidewire	0.035	260	Angled Stiff	Box 5
M00556241	NaviPro Hydrophilic Guidewire	0.035	260	Straight Stiff	Box 5

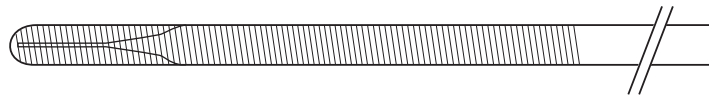

Pathfinder™ Exchange Guidewire



Order Number	Description	Distal Tip O.D. (in)	Working Length (cm)	Tip Style	Tip Length (cm)	Packaging
M00551591	Pathfinder Exchange Guidewire Stiff Shaft	.018	450	Shapeable	6.5	Box 2

Biliary

RX Preloaded Sphincterotome

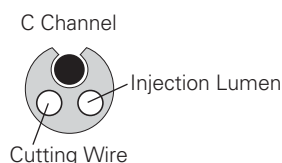
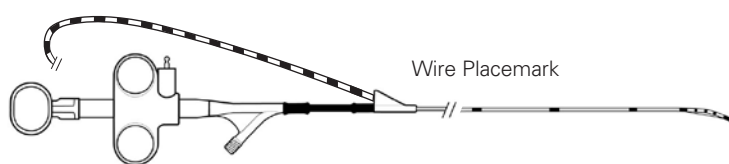

Dreamtome™ RX Cannulating Sphincterotome (Preloaded with Dreamwire™ High Performance Guidewire)



Order Number	Description	Tip Length (mm)	Cut Wire Length (mm)	Preloaded Guidewire (in / cm)	Packaging
M00584000	Dreamtome RX 49 Sphincterotome	5	20	.035 / 260 Dreamwire Guidewire	Each
M00584010	Dreamtome RX 49 Sphincterotome	5	30	.035 / 260 Dreamwire Guidewire	Each
M00584020	Dreamtome RX 49 Sphincterotome	5	20	.035 / 450 Dreamwire Guidewire	Each
M00584030	Dreamtome RX 49 Sphincterotome	5	30	.035 / 450 Dreamwire Guidewire	Each
M00584040	Dreamtome RX 44 Sphincterotome	5	20	.035 / 260 Dreamwire Guidewire	Each
M00584050	Dreamtome RX 44 Sphincterotome	5	30	.035 / 260 Dreamwire Guidewire	Each
M00584060	Dreamtome RX 44 Sphincterotome	5	20	.035 / 450 Dreamwire Guidewire	Each
M00584070	Dreamtome RX 44 Sphincterotome	5	30	.035 / 450 Dreamwire Guidewire	Each

*Preloaded with straight-tip guidewires only.
Active Cords sold separately (see page 13).

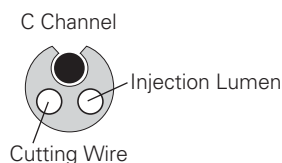
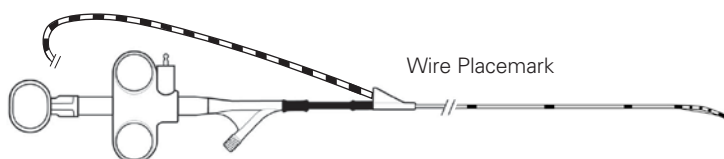

Hydratome™ RX Cannulating Sphincterotome (Preloaded with Hydra Jagwire™ Guidewire)



Order Number	Description	Cut Wire (mm)	Tip Length (mm)	Distal Tip O.D. (Fr)	Preloaded Guidewire (cm)	Guidewire Tip Style	Packaging
M00583000	Hydratome RX 49 Sphincterotome	20	5	4.9	260 Hydra Jagwire Guidewire	Straight	Each
M00583010	Hydratome RX 49 Sphincterotome	30	5	4.9	260 Hydra Jagwire Guidewire	Straight	Each
M00583020	Hydratome RX 49 Sphincterotome	20	5	4.9	450 Hydra Jagwire Guidewire	Straight	Each
M00583030	Hydratome RX 49 Sphincterotome	30	5	4.9	450 Hydra Jagwire Guidewire	Straight	Each
M00583040	Hydratome RX 44 Sphincterotome	20	5	4.4	260 Hydra Jagwire Guidewire	Straight	Each
M00583050	Hydratome RX 44 Sphincterotome	30	5	4.4	260 Hydra Jagwire Guidewire	Straight	Each
M00583060	Hydratome RX 44 Sphincterotome	20	5	4.4	450 Hydra Jagwire Guidewire	Straight	Each
M00583070	Hydratome RX 44 Sphincterotome	30	5	4.4	450 Hydra Jagwire Guidewire	Straight	Each

Active Cords sold separately (see page 13).

Biliary

RX Preloaded Sphincterotome (Continued)

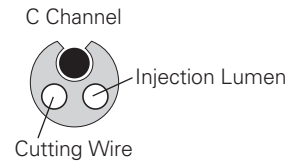
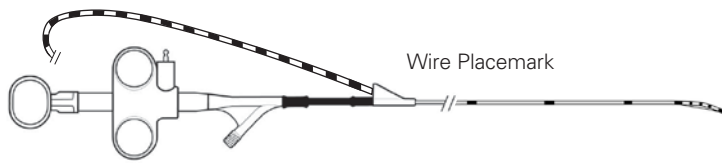

Jagtome™ RX Cannulating Sphincterotome (Preloaded with Jagwire™ Guidewire)



Order Number	Description	Cut Wire (mm)	Tip Length (mm)	Distal Tip O.D. (Fr)	Preloaded Guidewire (in / cm)	Guidewire Tip Style	Packaging
M00573000	Jagtome RX 49 Sphincterotome	20	5	4.9	.035 / 260 Jagwire Guidewire	Straight	Each
M00573010	Jagtome RX 49 Sphincterotome	20	5	4.9	.035 / 450 Jagwire Guidewire	Straight	Each
M00573020	Jagtome RX 49 Sphincterotome	30	5	4.9	.035 / 260 Jagwire Guidewire	Straight	Each
M00573030	Jagtome RX 49 Sphincterotome	30	5	4.9	.035 / 450 Jagwire Guidewire	Straight	Each
M00573040	Jagtome RX 44 Sphincterotome	20	5	4.4	.035 / 260 Jagwire Guidewire	Straight	Each
M00573050	Jagtome RX 44 Sphincterotome	20	5	4.4	.035 / 450 Jagwire Guidewire	Straight	Each
M00573060	Jagtome RX 44 Sphincterotome	30	5	4.4	.035 / 260 Jagwire Guidewire	Straight	Each
M00573070	Jagtome RX 44 Sphincterotome	30	5	4.4	.035 / 450 Jagwire Guidewire	Straight	Each
M00573080	Jagtome RX 39 Sphincterotome	20	5	3.9	.025 / 260 Jagwire Guidewire	Straight	Each
M00573090	Jagtome RX 39 Sphincterotome	20	5	3.9	.025 / 450 Jagwire Guidewire	Straight	Each
M00573100	Jagtome RX 39 Sphincterotome	30	5	3.9	.025 / 260 Jagwire Guidewire	Straight	Each
M00573110	Jagtome RX 39 Sphincterotome	30	5	3.9	.025 / 450 Jagwire Guidewire	Straight	Each

Active Cords sold separately (see page 13).

Biliary

RX Sphincterotome

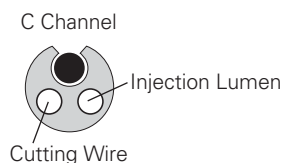
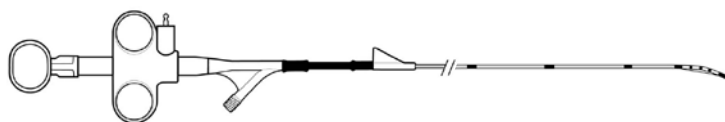

Autotome™ RX Cannulating Sphincterotome ⓧ

Order Number	Description	Cut Wire (mm)	Tip Length (mm)	Distal Tip O.D. (Fr)	Recommended Guidewire (in)	Packaging
M00545150	Autotome RX 49 Cannulating Sphincterotome	20	5	4.9	.035	Each
M00545160	Autotome RX 49 Cannulating Sphincterotome	30	5	4.9	.035	Each
M00545170	Autotome RX 44 Cannulating Sphincterotome	20	5	4.4	.035	Each
M00545180	Autotome RX 44 Cannulating Sphincterotome	30	5	4.4	.035	Each
M00545190	Autotome RX 39 Cannulating Sphincterotome	20	5	3.9	.025	Each
M00545200	Autotome RX 39 Cannulating Sphincterotome	30	5	3.9	.025	Each

Active Cords sold separately (see page 13).

Ultratome™ RX Cannulating Sphincterotome ⓧ

Order Number	Description	Cut Wire (mm)	Tip Length (mm)	Distal Tip O.D. (Fr)	Recommended Guidewire (in)	Packaging
M00545050	Ultratome RX Cannulating Sphincterotome, Short Nose	20	5	5.5	.035	Each
M00545060	Ultratome RX Cannulating Sphincterotome, Short Nose	30	5	5.5	.035	Each

Active Cords sold separately (see page 13).

RX Cholangiogram Kits* ⓧ

Order Number	Description	Sphincterotome	Guidewire	Accessory
M005XXXX1	Cholangiogram Kit	Autotome or Ultratome XL Sphincterotome	Jagwire™ Guidewire	N / A
M005XXXX1	Cholangiogram Kit-Preloaded	Autotome Sphincterotome	Jagwire Guidewire	RX Locking Device

*To order RX Cholangiogram Kits please contact your local Boston Scientific Endoscopy Sales Representative.

RX Needle Knife XL Triple-Lumen Needle Knife ⓧ

Order Number	Description	Length (cm)	Cut Wire (mm)	Distal Tip O.D. (Fr)	Recommended Guidewire (in)	Packaging
M00545840	RX Needle Knife	200	5	5.5	.035	Each

Biliary

Sphincterotome

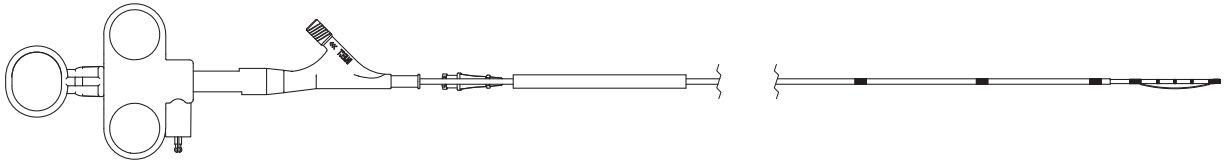

TRUEtome™ Cannulating Sphincterotome



Order Number	Description	Cut Wire Length (mm)	Tip Length (mm)	Distal Tip O.D. (Fr)	Recommended Guidewire (in)	Packaging
M00584190	TRUEtome 39 Sphincterotome	20	5	3.9	.025	Each
M00584120	TRUEtome 39 Sphincterotome	30	5	3.9	.025	Each
M00584170	TRUEtome 44 Sphincterotome	20	5	4.4	.035	Each
M00584180	TRUEtome 44 Sphincterotome	30	5	4.4	.035	Each
M00584150	TRUEtome 49 Sphincterotome	20	5	4.9	.035	Each
M00584160	TRUEtome 49 Sphincterotome	30	5	4.9	.035	Each

Active Cords sold separately (see page 13).

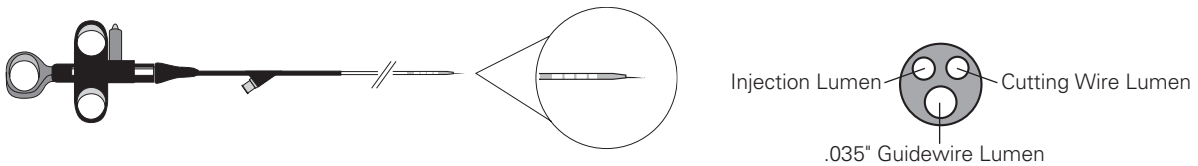

MicroKnife™ XL Triple-Lumen Needle Knife



Order Number	Description	Shaft O.D. (Fr)	Catheter Length (cm)	Recommended Guidewire (in)	Packaging
M00532810	MicroKnife XL Needle Knife	7.0 - 5.5	200	.035	Each

Active Cords sold separately (see page 13).

Biliary

Sphincterotome (Continued)

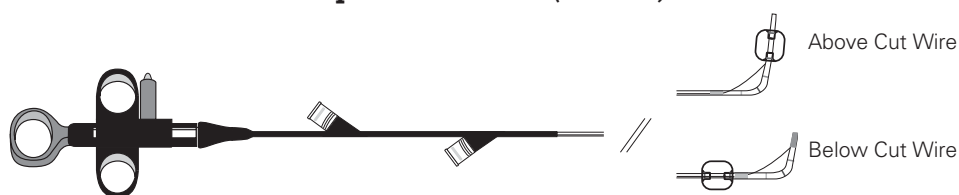

Stonetome™ Stone Removal Device



Order Number	Description	Balloon Diameter (mm)	Catheter Length (cm)	Tip Length (mm)	Cut Wire (mm)	Distal Tip O.D. (Fr)	Recommended Guidewire (in)	Packaging
M00535150	Stonetome Device (below cut wire)	11.5	200	5	20	5.5	.035	Each
M00535170	Stonetome Device (below cut wire)	11.5	200	20	20	5.5	.035	Each
M00535190	Stonetome Device (below cut wire)	11.5	200	5	30	5.5	.035	Each
M00535210	Stonetome Device (below cut wire)	11.5	200	20	30	5.5	.035	Each
M00535110	Stonetome Device (above cut wire)	11.5	200	20	20	5.5	.035	Each
M00535130	Stonetome Device (above cut wire)	11.5	200	20	30	5.5	.035	Each

Active Cords sold separately (see page 13).

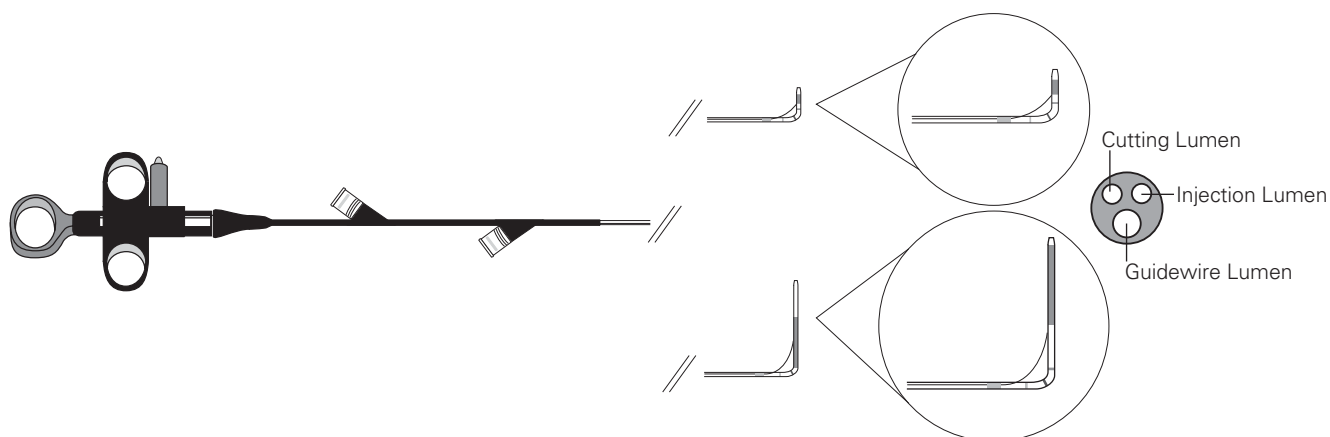

Ultratome™ XL Triple-Lumen Sphincterotome



Order Number	Description	Wire Length (mm)	Shaft O.D. (Fr)	Catheter Length (cm)	Tip Length (mm)	Recommended Guidewire (in)	Packaging
M00535900	Ultratome XL Short Nose Sphincterotome	20	5.5	200	5	.035	Each
M00535910	Ultratome XL Long Nose Sphincterotome	20	5.5	200	20	.035	Each
M00535920	Ultratome XL Short Nose Sphincterotome	30	5.5	200	5	.035	Each
M00535930	Ultratome XL Long Nose Sphincterotome	30	5.5	200	20	.035	Each

Active Cords sold separately (see page 13).

Biliary

Sphincterotome (Continued)

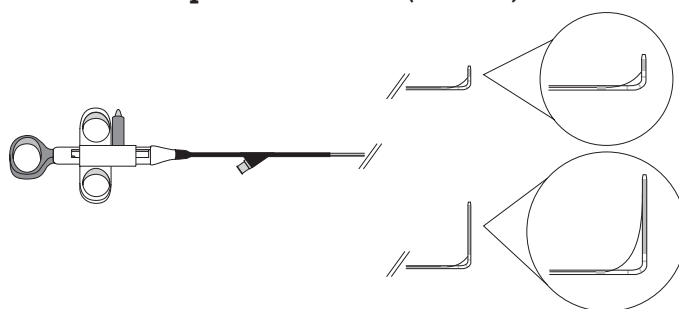

Ultratome™ Double-Lumen Sphincterotome



Order Number	Description	Wire Length (mm)	Distal Tip O.D.		Catheter Length (cm)	Tip Length (mm)	Recommended Guidewire (in)	Packaging
			(mm)	(Fr)				
M00530800	Ultratome Short Nose Sphincterotome	20	1.8	5.5	200	5	.035	Each
M00530810	Ultratome Long Nose Sphincterotome	20	1.8	5.5	200	20	.035	Each
M00530820	Ultratome Short Nose Sphincterotome	30	1.8	5.5	200	5	.035	Each
M00530830	Ultratome Long Nose Sphincterotome	30	1.8	5.5	200	20	.035	Each

Active Cords sold separately (see page 13).

RX Cannulas



Rapid Exchange XL Cannula



Order Number	Description	Working Length (cm)	Tip Style	Recommended Guidewire (in)	Packaging
M00545820	Rapid Exchange XL Cannula	195	tapered	.035	Each

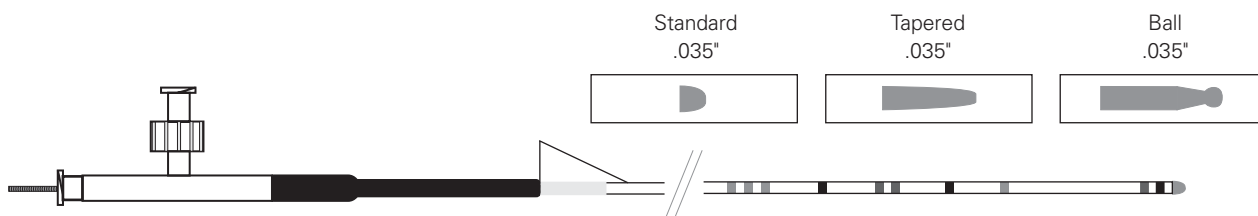

RX ERCP Cannulas



Order Number	Description	Working Length (cm)	Recommended Guidewire (in)	Packaging
M00545760	RX ERCP Cannula Standard Tip	210	.035	Each
M00545770	RX ERCP Cannula Tapered Tip	210	.035	Each
M00545780	RX ERCP Cannula Ball Tip	210	.035	Each

Biliary

Cannulas

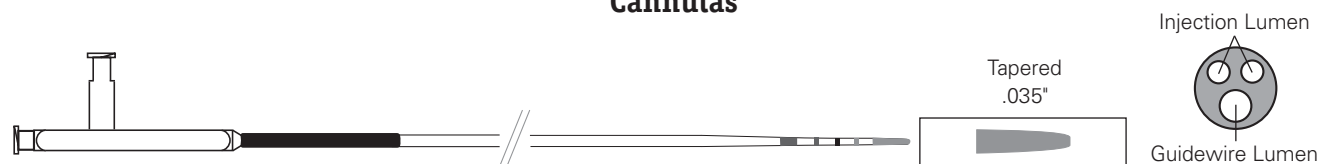

Tandem™ XL Triple-Lumen ERCP Cannula



Order Number	Distal Tip O.D.		Catheter Size (Fr)	Working Length (cm)	Tip Style	Recommended Guidewire (in)	Packaging
	(Fr)	(mm)					
M00535700	5.5	1.8	7.0 – 5.5	200	Tapered	.035	Each

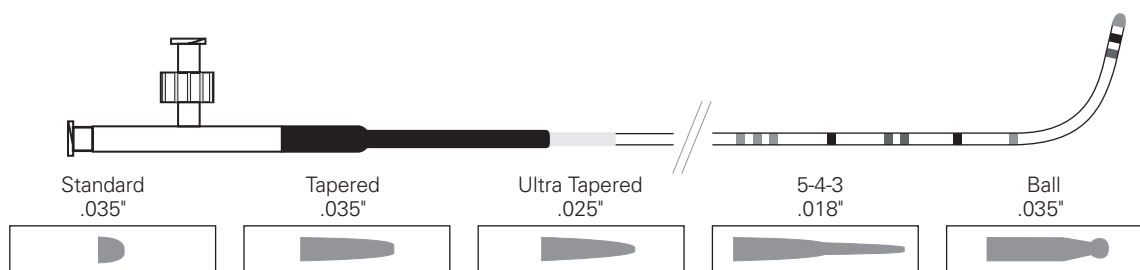

Contour™ ERCP Cannulas



Order Number	Description	Distal Tip O.D.		Working Length (cm)	Tip Style	Recommended Guidewire (in)	Packaging
		(Fr)	(mm)				
M00530850	Contour ERCP Cannula	5	1.7	210	Standard	.035	Each
M00530860	Contour ERCP Cannula	5	1.7	210	Tapered	.035	Each
M00530870	Contour ERCP Cannula	5	1.7	210	Ultra Tapered	.025	Each
M00530880	Contour ERCP Cannula	5	1.7	210	5-4-3	.018	Each
M00530890	Contour ERCP Cannula	5	1.7	210	Ball Tip	.035	Each

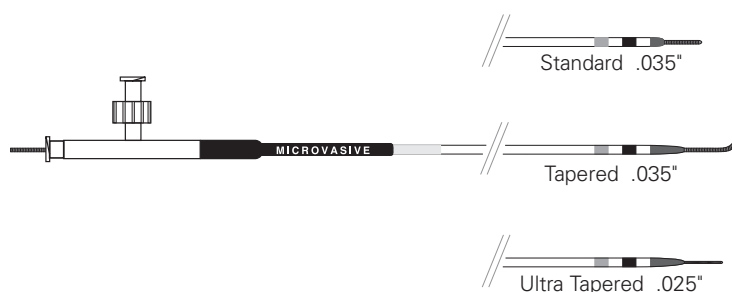

Fluoro Tip™ ERCP Cannulas



Order Number	Description	Distal Tip O.D.		Working Length (cm)	Recommended Guidewire (in)	Packaging
		(mm)	(Fr)			
M00530960	Fluoro Tip ERCP Cannula Standard Tip	1.7	5	210	.035	Each
M00530970	Fluoro Tip ERCP Cannula Tapered Tip	1.7	5	210	.035	Each
M00530980	Fluoro Tip ERCP Cannula Ultra Tapered Tip	1.7	5	210	.025	Each

Biliary

Accessories

RX Locking Devices and Biopsy Cap Systems

Order Number	Description	Packaging
M00545471	RX Locking Device (Biopsy Cap not included)	Box 10
M00545211	RX Locking Device – Olympus™ / Fujinon™ Brand Endoscope Compatible	Each
M00545261	RX Locking Device and Biopsy Cap System – Olympus Brand Endoscope Compatible	Box 10
M00545271	RX Locking Device and Biopsy Cap System – Pentax™ Brand Endoscope Compatible	Box 10
M00545281	RX Locking Device and Biopsy Cap System – Fujinon Brand Endoscope Compatible	Box 10

Active Cords (Fit Boston Scientific Endoscopy Sphincterotome)

Order Number	Description	Packaging
M00561250	Active Cord, Fits Olympus Brand Generator	Each
M00561270	Active Cord, Fits Endostat™, Endostat II and Endostat III Generators, Bovie™, Valleylab™, Aspen Labs™, and ERBE™ Brand Generators	Each

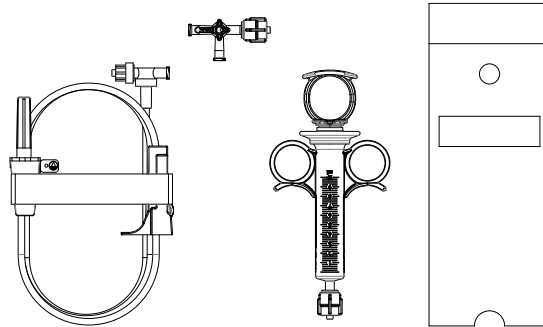

Rapid Refill Continuous Injection System



Order Number	Description	Packaging
M00566001	Rapid Refill Continuous Injection System	Box 10

